

W-5
600TV LINES

USER MANUAL

ULTRA HIGH RESOLUTION DIGITAL DAY/NIGHT PIR CAMERA

ZD2812WL/PIR



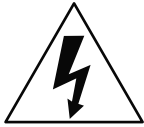

The lightning flash with an arrowhead symbol, within an equilateral triangle is intended to alert the user to the presence of uninsulated dangerous voltage within the product's enclosure that may be of sufficient magnitude to constitute a risk of electric shock to persons.



The exclamation point within an equilateral triangle is intended to alert the user to the presence of important operating and maintenance (servicing) instructions in the literature accompanying the appliance.

INFORMATION - This equipment has been tested and found to comply with limits for a Class A digital device, pursuant to part 15 of the FCC Rules & CE Rules. These limits are designed to provide reasonable protection against harmful interference when the equipment is operated in a commercial environment. This equipment generates, uses, and can radiate radio frequency energy and, if not installed and used in accordance with the instruction manual, may cause harmful interference to radio communications. Operation of this equipment in a residential area is likely to cause harmful interference in which case the user will be required to correct the interference at their own expense.

WARNING - Changes or modifications not expressly approved by the manufacturer could void the user's authority to operate the equipment.

CAUTION : To prevent electric shock and risk of fire hazards:
☞ Do NOT use power sources other than those specified.

This installation should be made by a qualified service person and should conform to all local codes.

Precautions

Do not install the camera in extreme temperature conditions.



Only use the camera in conditions where temperatures are between -20°C and $+50^{\circ}\text{C}$. Be especially careful to provide ventilation when operating under high temperatures.

Do not install or use the camera in an environment where the humidity is high.

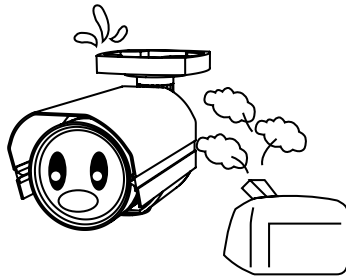

Do not install or use the camera in an environment where the humidity is high.

Do not install the camera under unstable lighting conditions.

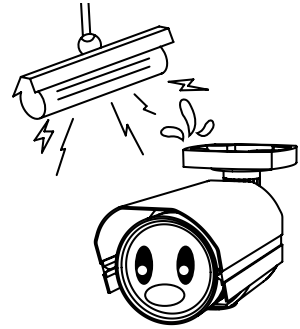

Severe lighting change or flicker can cause the camera to work improperly.

Do not touch the front lens of the camera.

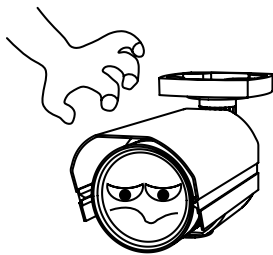

This is one of the most important parts of the camera. Be careful not to leave fingerprints on the lens cover.

Never keep the camera pointed directly at strong light.

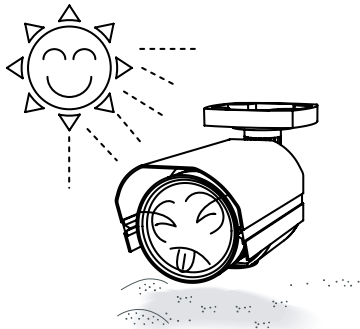

Severe lighting change or flicker can cause the camera to work improperly.

Do not drop the camera or subject it to physical shocks.



It can cause malfunctions to occur.

Do not expose the camera to radioactivity.

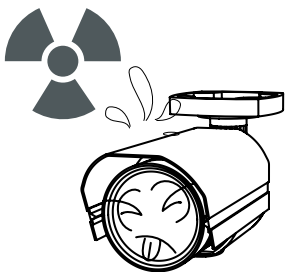

If exposed to radioactivity the CCD will fail.

NOTE

* If the camera is exposed to spotlight or an object reflecting strong light, smear or blooming may occur.

* please check that the power satisfies the normal specification before connecting the camera.

Specification

Ultra High Resolution Digital Day&Night PIR Camera

Built-in 30-power White LEDs with CDS Sensor
Camera OSD Control



600TV Lines
DC Auto Iris Varifocal
Lens (2.8mm-12mm)
White LEDs * 30pcs
IP 66

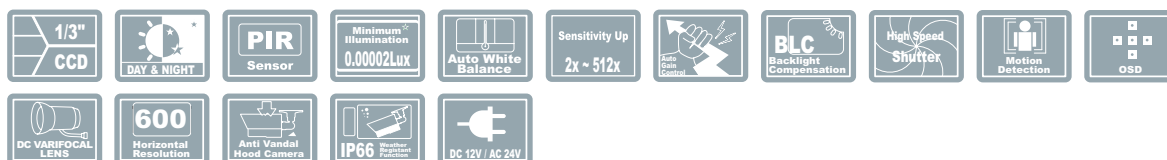

SPECIFICATIONS

MODEL	ZD2812WL/PIR
Image Pick-Up Device	1/3" Sony Super HAD CCD II
TV System	NTSC, PAL
Total Pixels	NTSC=811(H) * 508(V) / PAL=795(H) * 596(V)
Effective Pixels	NTSC=768(H) * 494(V) / PAL=752(H) * 582(V)
Scanning Frequency	NTSC=15.734KHz(H) & 59.94Hz(V) / PAL=15.625KHz(H) & 50.00Hz(V)
Scanning System	2:1 Interlace
Synchronisation	Internal
Resolution	600TV Lines
Minimum Illumination	CDS OFF: 0.15 Lux, CDS ON: 0.00002 Lux
S/N Ratio	More than 52dB
Video Output	CVBS: 1.0Vp-p / 75Ω
Electronic Shutter Speed	NTSC=(1/60sec~1/120,000sec) / PAL=(1/50sec~1/120,000sec)
OSD	Available
SSDR	On / Off (Level adjustable)
BLC	BLC / HLC / OFF
Day & Night	Colour / BW / AUTO / EXT
Gain Control	Low / High / Off
White Balance	ATW / Outdoor / Indoor / Manual / AWC (1,700°K ~ 11,000°K)
SENS-UP	Auto / Off (Selectable x2 ~ x512)
Motion Detection	On / Off (8 Programmable Zones)
Privacy Masking	On / Off (12 Programmable Zones)
SSNR III (Digital Noise Reduction)	On / Off (Level adjustable)
Digital Zoom	On / Off (x1 ~ x16)
DIS (Digital Image Stabilization)	On / Off
Sharpness	On / Off (Level adjustable)
Filp / Mirror	On / Off / V-Rev / H-Rev
Power Supply	DC 12V / AC 24V-Dual Voltage
Power Consumption	CDS ON:500mA Max
Lens	DC Auto Iris Varifocal Lens(2.8mm-12mm)
Operational Temp.	-20 ~ +50 Deg C. RH95% MAX.
Storage Temp.	-20 ~ +60 Deg C. RH95% MAX.
Dimension	88mm(W) * 115mm(H) * 245mm(D)
Weight	1600g

General Features

- * 1/3" SONY Super HAD CCD
- * Ultra High Resolution : Colour - 600TV Lines / B/W - 700 TV Lines
- * Max. Sens-Up (x512), 0.00002 Lux of Min. Illumination
- * Convenient OSD Control Function
- * x16 Digital Zoom
- * Free Area Selectable Function of BLC and MD
- * Privacy Color Masking for 12 Area Selection
- * Digital Day/Night
- * Max 70% of Disk Saving Effect with Super DNR
- * DC 12V / AC24V(Dual Voltage)

Dimensions

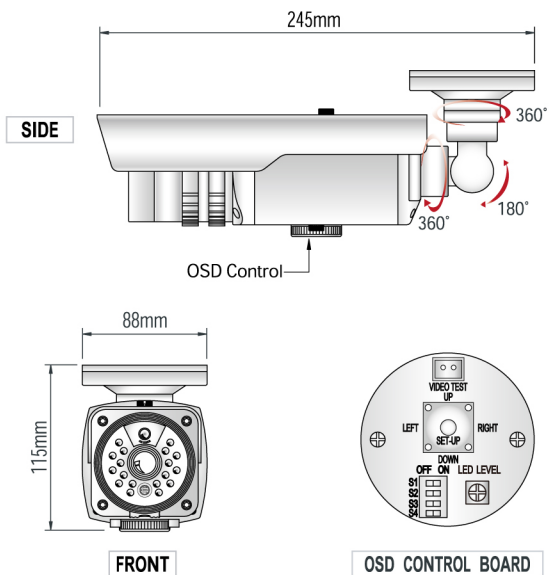

DIMENSIONS

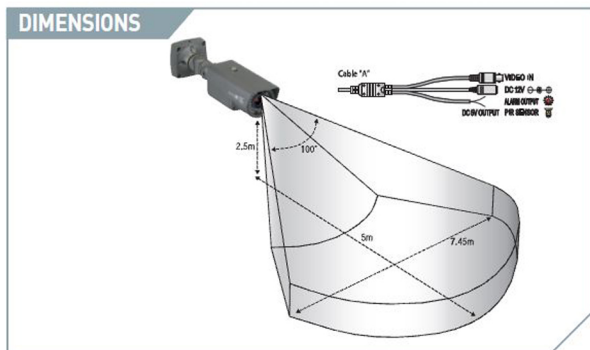

Camera Adjustment

- ① Connect Video & Power Line (12V DC/24V AC Regulated)
- ② Position the camera for the correct angle of view.
- ③ Loosen the locking screws and focus the camera.
- ④ Re-tighten the locking screws.

SETTING

Settings can be made using the OSD button located in the body housing.

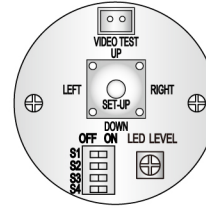

OSD Control Board

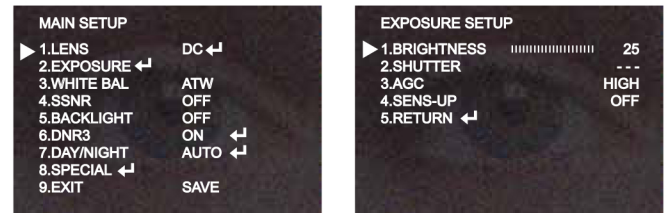

HOW To Install

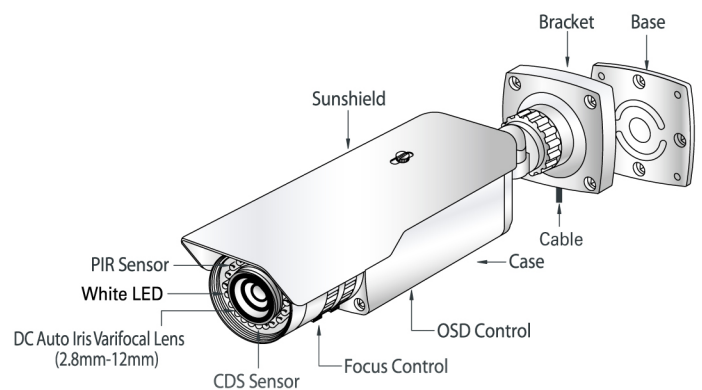

Contents

● Contents	1
● Safety Instructions	2
● General Features	3
● OSD Control Button	4
● Camera Menu Set Up	5
1. Menu Set Up	5
2. Lens Setting	5
3. Exposure Setting	6
4. White Balance Setting	7
5. SSNR Setting	8
6. Backlight Setting	9
7. DNR3 Setting	10
8. Day/Night Setting	11
9. Special Setting	12
10. Exit Setting	17
● Trouble Shooting	18

Safety Instructions

Precautions for use

- ☞ Please read this manual thoroughly before using the camera to become familiar with the correct operational procedures.

Cautions When Using

- ☞ Do not open the camera body and touch any electrical parts to avoid possible electric shocks.
- ☞ Do not insert objects into the camera body to prevent fire hazards and electric shock.
- ☞ Do not touch the camera with wet hands - to avoid an electric shock.
- ☞ Do not disconnect the power cord from a power plug when still connected to the outlet.
- ☞ Always disconnect the power by removing the plug from the power socket.
- ☞ If the camera emits a burning smell, immediately disconnect it from the power source and report the problem to your distributor.

Cautions When Install

- ☞ Only apply power after installation of the product.
- ☞ Do not install the camera in a position facing directly at a strong light source.
- ☞ Do not install or use the camera in areas of high humidity.
- ☞ Do not install near any cooling or heating equipment.
- ☞ Do not install the camera in dusty environments.
- ☞ Do not install the camera in places where the camera is subjected to physical shocks.
- ☞ This products must be used with a regulated adaptor for power, such as the Genie PSU1SM.

General Features

● Ultra High Sensitivity

- The built-in high sensitivity COLOUR CCD produces a clear image even in 0Lux(B/W, IR-LED ON) or lower illumination.

● 600TV Lines

- By adopting a diagonal 6mm(1/3") 410,000 (NTSC) pixel, 470,000(PAL) pixel SONY CCD, the camera produces clear picture quality with a horizontal resolution of 600 TV lines for colour and a horizontal resolution of 700TV lines for BW mode.

● DNR3

- The high-performance W-V DSP chip effectively removes low-light gain noise and ghosting to provide clear images even in dark environments.

● Day & Night

- This camera has a function that automatically selects the mode that is appropriate for daytime or night-time conditions.

The COLOUR mode operates in daytime conditions to provide optimum colours, and BW mode operates in night-time conditions to enhance the definition of the image.

● SSNR

- For images with high contrast between bright and dark Areas from difficult lighting conditions such as backlighting, this camera selectively illuminates darker Areas while retaining the same light level for brighter Areas to even out the overall brightness.

● Miscellaneous Functions

- HLC(High Light Compensation), SENS-UP, FLIP(H/V-REV), D-ZOOM, SHARPNESS, MOTION DETECTION and PRIVACY functions are provided.

● Disk Saving Effects

- Up-most and advanced DNR technology camera picture quality has a disk saving effects due to Image sizes are smaller than standard CCTV camera image.

● Controlled by OSD Menu

- The camera can be controlled by selecting the menu text displayed on the monitor screen.

● PIR Sensor

- Built-in PIR sensor makes white LED "ON" when forces somebody's entry as a warning system or function of the light.

OSD Control Button

1. Type A, Type B, Type C of OSD button could be used when it needs to OSD control.
2. Type D is extra Option (wired Remote controller)

Type A

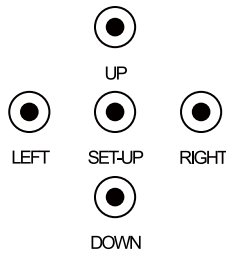

Type.B

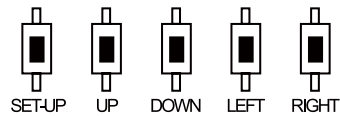

Type C

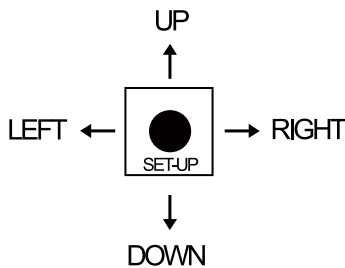

Type D (Option)

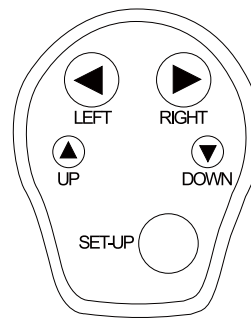

- ▲ Up button: Moves the cursor upwards. Use this button to select an item or adjust the parameters.
- ▼ Down button: Moves the cursor downwards. Use this button to select an item or adjust the parameters.
- ◀ Left button: Moves the cursor to the left. Use this button to select or adjust the parameters of the selected item. The parameter changes each time this button is pressed.
- ▶ Right button: Moves the cursor to the right. Use this button to select or adjust the parameters of the selected item. The parameter changes each time this button is pressed.
- ◎ Set button: Executes selections and displays a submenu for an item with the mark.

● Menu Setup

1. Press the Function Setup switch.
 - Main setup menu is displayed on the monitor screen.

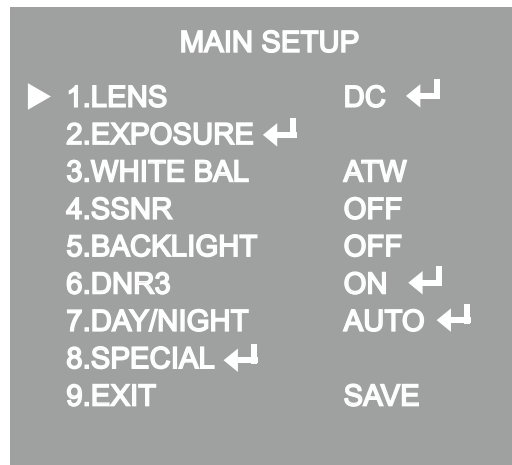

2. Select a desired function using the Function Setup switch.
 - Place the cursor over a desired item.
3. Set up a selected item by using the Function Setup switch.
4. To finish the setting, select 'EXIT' and press the Function Setup switch.

NOTE

- An item with the ◀ icon also has sub menus. To select a sub menu, select an item with the icon and press the Function Setup switch.
- An item with the - - - icon is unavailable due to function settings.

● Lens Setting

Using this function, you can control the screen brightness.

1. When the SETUP menu screen is displayed, select 'LENS' by using the Function Setup switch so that the arrow indicates 'LENS'.
2. DC : You can adjust the minimum shutter and maximum value of ESC shutter mode.

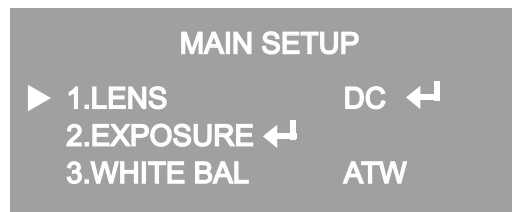

3. THE Lens mode has sub menu items as listed below.
 - BRIGHTNESS : Adjusts the video brightness.

– FOCUS ADJ : To adjust the DC lens focus correctly, you must activate the Focus Settings mode under each lens menu. Activate the Focus Settings mode, adjust the lens focus, and then deactivate the settings mode.

NOTE

■ If colour rolling occurs when using a DC lens, set Shutter to Fixed (---).

● Exposure Setting

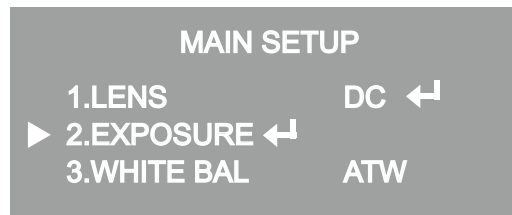

1. When the SETUP menu screen is displayed, select 'EXPOSURE' by using the Function Setup Switch.
2. Select a desired mode using the Function Setup switch.

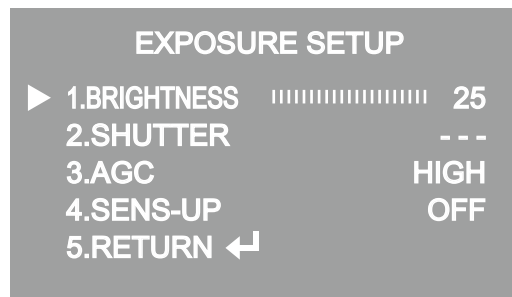

- ◆ SHUTTER : You can select either auto or manual shutter.
- * --- : Shutter speed is fixed at 1/60sec(1/50sec)
- * ESC : Select this to control the shutter speed automatically. If ESC is selected, the shutter speed is automatically controlled depending on the ambient illumination of the subject.
- * MANUAL : You can control shutter speed manually.
(NTSC MODEL : 1/60~1/120,000, PAL MODEL : 1/50~1/120,000)
- * A,FLK : Select this when you see picture flicker, this can happen when the frequency of the local lighting clashes with the camera.

NOTE

■ When the SHUTTER is set to MANUAL or A.FLK mode, SENS-UP will be disabled.

- ◆ AGC(AUTO GAIN CONTROL) : The higher the gain level, the brighter the screen
– but the higher the noise.
- * OFF : Deactivates the AGC function.
- * LOW : Allows automatic gain control from 5.3dB to 32dB.
- * HIGH : Allows automatic gain control from 5.3dB to 37dB.
- ◆ SENS-UP : When it is night or dark, the camera automatically detects the light level and maintains a clear picture if this mode is activated.
- * OFF : Deactivates the SENS-UP function.
- * AUTO : Activates the SENS-UP function.
- ◆ RETURN : Select this to save the changes in the EXPOSURE menu and return to the SETUP menu.

NOTE

- If you press the Function Setup switch to 'AUTO' mode, you can adjust brightness by increasing or decreasing the shutter speed. (x2 ~ x512)
- Note that the higher the zoom level, the brighter the screen, but the more likely there will be a ghosting effect.
- It is normal for Noise, Spots and Whitish symptoms to appear in SENS-UP mode when the D-ZOOM level is increased.

● White Balance (White Bal) Setting

Use the White Balance function to adjust the screen colour.

1. When the SETUP menu screen is displayed, select 'White Bal' by using the Function Setup switch so that the arrow indicates 'White Bal'.
2. Select a desired mode using the Function Setup switch.

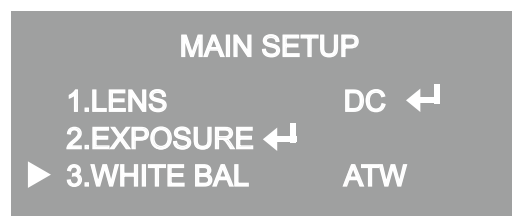

- ※ Select one of the following 5 modes, as appropriate for your purpose.
- ◆ **ATW** : Select this when the colour temperature is between 1,700 ° K and 11,000 ° K.
- ◆ **OUTDOOR** : Select this when the colour temperature is between 1,700 ° K and 11,000 ° K.
(sodium light inclusion)
- ◆ **INDOOR** : Select this when the colour temperature is between 4,500 ° K and 8,500 ° K.
- ◆ **MANUAL** : Select this to fine-tune White Balance manually. Set White Balance first by using the ATW or AWC mode. After that switch to MANUAL mode, fine-tune the White Balance and then press the Function Setup switch.
- ◆ **AWC→SET** : To find the optimal luminance level for the current environment, point the camera towards a sheet of white paper and press the Function Setup switch. If the environment changes, readjust it.

NOTE

■ **White Balance may not work properly under the following conditions. In this case select the AWC mode.**

- ① **When the colour temperature of the environment surrounding the subject is out of the control range (e.g. clear sky or sunset).**
- ② **When the ambient illumination of the subject is dim.**
- ③ **If the camera is directed towards a fluorescent light or is installed in a place where illumination changes dramatically, the White Balance operation may become unstable.**

● SSNR Setting

SSNR illuminates darker spots of an image while retaining the same light level for brighter spots to even out the overall brightness of images with high contrast between bright and dark spots.

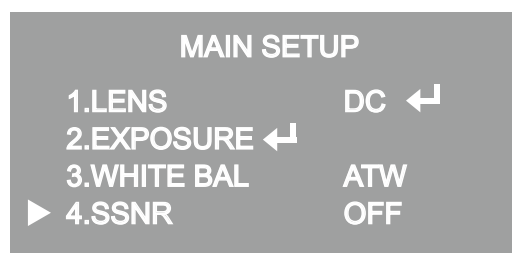

1. When the SETUP menu screen is displayed, select 'SSNR' by using the switch so that the arrow indicates 'SSNR'.
2. Use the switch to change the SSNR level according to the contrast between bright and dark areas.

● Backlight Setting

Unlike conventional cameras, the ZD2812WL/PIR is designed to deliver a distinctive subject and background at the same time, even when the subject is backlight, by using the features of the proprietary W-V DSP chip.

1. When the SETUP menu screen is displayed, select 'BACKLIGHT' by using the Function Setup switch so that the arrow indicates 'BACKLIGHT'.

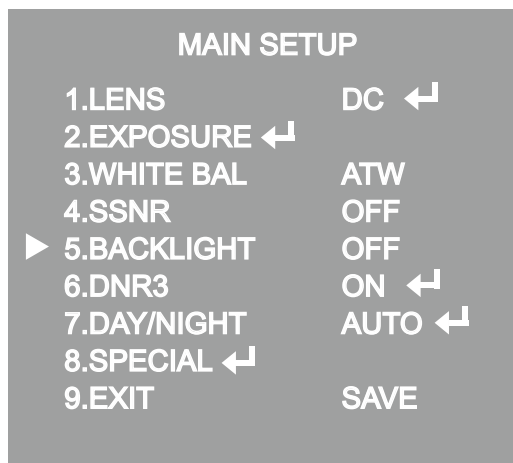

2. Select a desired mode using the Function Setup switch.

- ◆ BLC : Enables a user to directly select a desired area from a picture, and to view the area more clearly.
- ◆ HLC (High Light Compensation) : If the scene contains extremely bright light areas such as; from car headlights, the light can mask out much of the on-screen detail
 - LEVEL : Adjust level of the HLC function.
 - LIMIT : Enable to change the operating condition.
 - MASK COLOR/TONE : Change the colour / transparency of the masking area.
(Black, Red, Blue, Cyan, Magenta)
 - TOP/BOTTOM/LEFT/RIGHT : Adjust the area to be enhanced
- ◆ OFF : Not being used

2. Select a desired mode using the Function Setup switch and press the Function Setup switch.

- ◆ Select 'BLC' to adjust the area to be enhanced then adjust the level.
- ◆ Select 'HLC' to adjust the area to be enhanced then adjust the level.

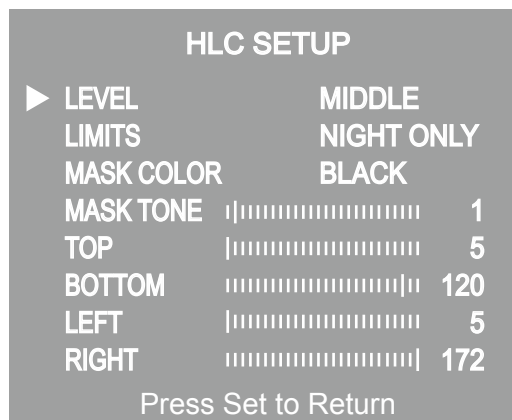
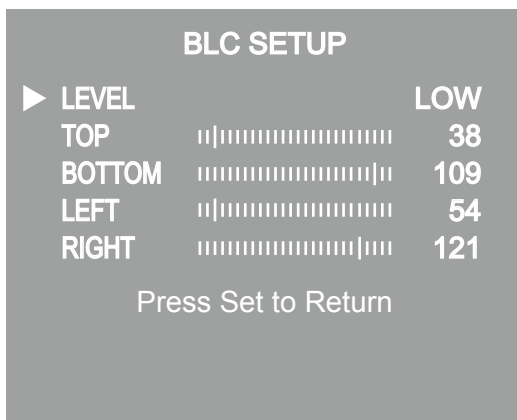

NOTE

- Because there can be a difference in the effectiveness of HLC according to the amount of light area in the screen, optimize the installation angle for the best HLC performance.
- When dark, the HLC is only activated when a bright light exceeding a specific size in NIGHT ONLY mode.
- The HLC is not activated in day light or when bright light is not present at night in NIGHT ONLY mode.
- BLC Function doesn't work in the B/W mode of the DAY/NIGHT menu.

● DNR3 Setting

This function reduces the background noise in a low luminance environment.

1. When the SETUP menu screen is displayed, select 'DNR3' by using the Function Setup switch so that the arrow indicates 'DNR3'.

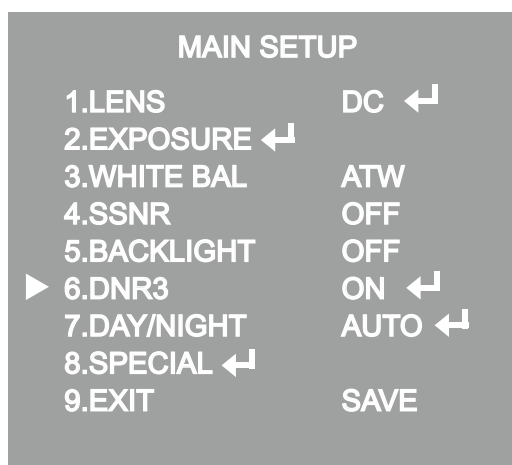

2. Select a desired mode using the Function Setup switch.

- ◆ OFF : Deactivates DNR3. Noise is not reduced.
- ◆ ON : Activates DNR3 so that noise is reduced.

3. Set the DNR3 mode to 'ON' and press the Function Setup switch. Then you can adjust the noise reduction level.

NOTE

- You cannot set the DNR3 to 'ON' or 'OFF' when the AGC mode of the EXPOSURE menu is 'OFF'.
- When adjusting the noise reduction level in the DNR3 mode, remember that the higher the level set, the more the noise level will be reduced, as will the brightness of the image.

● Day/Night Setting

You can display pictures in colour or black and white.

1. When the SETUP menu screen is displayed, select 'DAY/NIGHT' by using the Function Setup switch so that the arrow indicates 'DAY/NIGHT'.

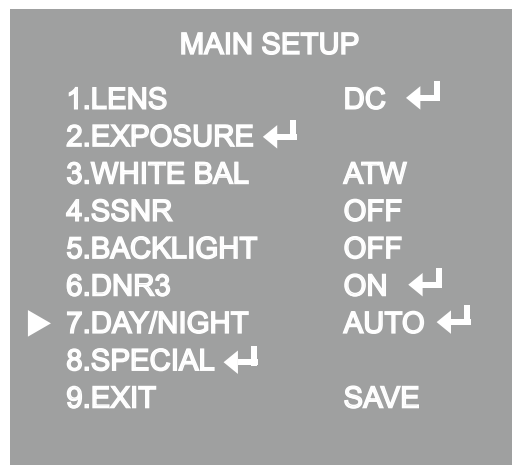

2. Select a desired mode using the Function Setup Switch according to the picture display you want.

- ◆ COLOR : The picture is always displayed in colour.
- ◆ B/W : The picture is always displayed in black and white.
- BURST MODE : You can turn on or off the burst signal on B/W mode.

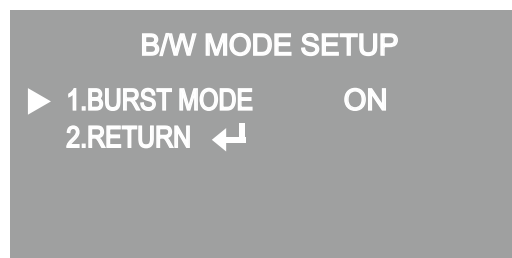

◆ **AUTO** : The mode is switched to 'Colour' in a normal environment, but switches to 'B/W' mode when ambient illumination is low. To set up the switching time for AUTO mode, press the Function Setup switch. You can turn on or off the burst signal on B/W mode.

- **BURST MODE** : You can turn on or off the burst signal on B/W mode.
- **DURATION** : You can select brightness of illumination about changing the day/night mode.
- **DWELLTIME** : You can select the duration time about changing the day/night mode.
→3s, 5s, 7s, 10s, 15s, 20s, 30s, 40, 60s

AUTO SETUP	
▶ 1.BURST MODE	ON
2.COLOR→B/W	
DURATION	FAST
DWELL TIME	3SEC
3.B/W→COLOR	
DURATION	FAST
DWELL TIME	10SEC
4.RETURN ◀	

	COLOR→B/W	B/W→COLOR
FAST	2.5 lux	5 lux
SLOW	1 lux	10 lux

* The day/night switching point of the camera can be adjusted.

◆ **EXTERN** : This mode allows the application of a filter to external signals.

NOTE

- When **AGC** in the **EXPOSURE** menu is set to **OFF** **AUTO** mode cannot be selected.

● Special Setting

1. When the **SETUP** menu screen is displayed, select 'SPECIAL' by using the Function Setup switch so that the arrow indicates 'SPECIAL'.

MAIN SETUP	
1.LENS	DC ◀
2.EXPOSURE ◀	
3.WHITE BAL	ATW
4.SSNR	OFF
5.BACKLIGHT	OFF
6.DNR3	ON ◀
7.DAY/NIGHT	AUTO ◀
▶ 8.SPECIAL ◀	
9.EXIT	SAVE

2. Select a desired mode using the Function Setup switch.



◆ IMAGE ADJ. :

- 1) When the SETUP menu screen is displayed, select 'IMAGE ADJ' by using the Function Setup switch so that the arrow indicates 'IMAGE ADJ'.
- 2) Select a desired mode using the Function Setup switch.

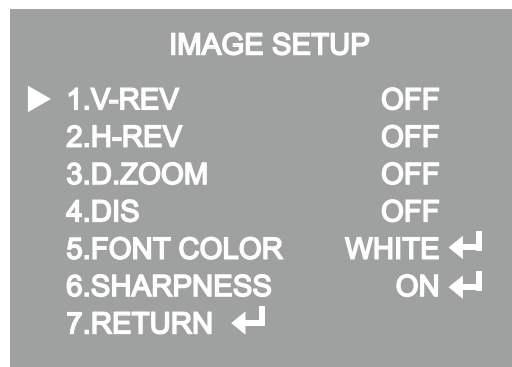

- * V-REV : You can flip the picture vertically on the screen.
- * H-REV : You can flip the picture horizontally on the screen.
- * D-ZOOM : You can use a digital zoom of x1 ~ x16.
- * DIS : This function mitigates any picture movement due to external factors such as wind.
- * FONT COLOR : You can change the OSD font colour. (White, Yellow, Green, Red, Blue)
- * SHARPNESS : As you increase this value, the picture outline becomes stronger and clearer.
Adjust this value appropriately depending on the sharpness of the picture.
- * MONITOR : Please change the settings value of video appropriate to your monitor.
 - LCD : Please select this menu item when using a LCD monitor.
 - CRT : Please select this menu item when using a CRT monitor.
 - USER : Please use this menu item when using a monitor other than standard ones. You can change the gamma, PED level, and color gain in the sub menus.
- * RETURN : Select this to save the settings for the IMAGE ADJ menu and to return to the SETUP menu.

NOTE

- When the V-REV or H-REV mode is enabled, the text on the screen does not flip.
- If you increase the SHARPNESS level too high, the picture may become distorted or noise may appear.

◆ CAM TITLE : If you enter a title, the title will appear on the monitor.

- 1) If the SPECIAL menu screen is displayed, use the Function Setup switch so that the arrow indicates 'CAM TITLE'.
- 2) Set it to 'ON' by using the Function Setup switch.
- 3) Press the Function Setup switch.
- 4) Use the Function Setup switch to move to a desired letter and select the letter by pressing the Function Setup switch. Repeat this to enter multiple letters. You can enter up to 15 letters.
- 5) Enter a title, move the cursor to 'POS' and press the Function Setup switch. The entered title appears on the screen. Select the position to display the title on the screen by using the Function Setup switch and press the Function Setup switch. When the position is determined, select 'END' and press the Function Setup switch to return to the SPECIAL menu.



NOTE

- When the CAM TITLE menu is 'OFF', no title will be displayed on the monitor screen even if you enter one.
- Only English is available in this mode.
- If you move the cursor to CLR and press the Function Setup switch, all the letters are deleted. To edit a letter, change the cursor to the bottom left arrow and press the Function Setup switch. Move the cursor over the letter to be edited, move the cursor to the letter to be inserted and then press the Function Setup switch.

◆ SYNC

INT : Internal Synchronisation Type

NOTE

■ When the power is DC 12V, the SYNC menu is fixed to the 'INT' mode.

◆ **MOTION DET** :This product has a feature that allows you to observe movement of objects in 8 different areas on the screen, and the words 'MOTION DETECTED' appear on the screen when movement is detected. Activity can be monitor more efficiently.

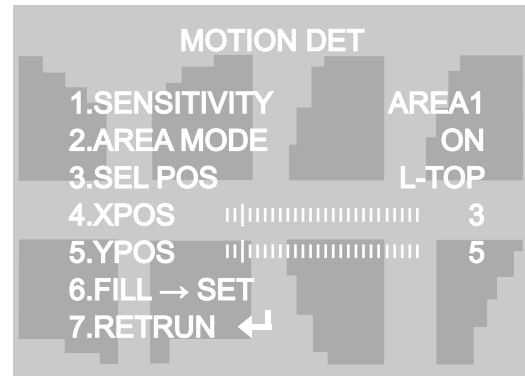

1) When the SPECIAL menu screen is displayed, press the Function Setup switch so that the arrow indicates 'MOTION DET' .

2) Set up the mode using the Function Setup switch.

- SENSITIVITY : You can select up to 8 MD areas. When SENSITIVITY number is high, motion detection sensitivity is increased to recognize even small movement.
- AREA MODE : Determines whether to use the MD area selected in SENSITIVITY.
- SEL POS : Determines which of the 4 vertices of each MD area is to be used.
- XPOS : Determines the coordinate of the horizontal axis for SEL POS.
- YPOS : Determines the coordinate of the vertical axis for SEL POS.
- FILL→SET : Fills in a selected MD area. The colour of the area can be selected from brown, orange, blue, cyan, green, yellow, magenta and red.
- RETURN : Select this to save the MOTION DET menu settings and return to the SPECIAL menu.

◆ **PRIVACY** : Mask an area you want to hide on the screen.

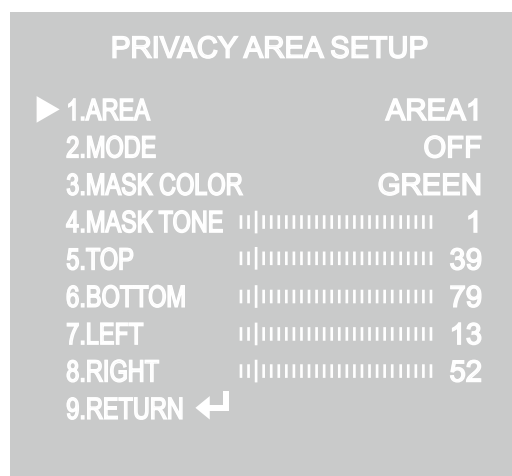

1) When the SPECIAL menu screen is displayed, press the Function Setup switch so that the arrow indicates 'PRIVACY'.

2) Set up the mode using the Function Setup switch.

- AREA : You can select up to 12 PRIVACY areas.
- MODE : Determines whether to use the area selected in the AREA.
- MASK COLOR : Determine area colour. You can select Green, Red, Blue, Black, White, Gray.
- MASK TONE : Adjust the brightness of MASK COLOUR.
- TOP/BOTTOM/LEFT/RIGHT :Adjust the size and position of the selected area.
- RETURN : Select this to save the PRIVACY menu settings and return to the SPECIAL menu.

◆ COMM ADJ (Communication Adjustment) :

This function sets up the camera communication status when controlling the camera through an external control device.

1) When the SPECIAL menu screen is displayed, press the Function Setup switch so that the arrow indicates 'COMM ADJ'.

2) Set up the mode using the Function Setup witch.

- CAM ID : Determines the camera's identification number (between 0 and 255).
- BAUD RATE : You can select 2400/4800/9600/19200/38400/57600 bps.
- UART MODE : You can select NONE, EVEN or ODD for the parity bits.
- RET PKT : Determines whether to send a command back to the controller device when a communication control command is sent to the camera.
- DISP ID : Display camera title on top left corner of the screen.
- PROTOCOL : You can select one of various protocols. STW(SPD), PELCO-P, PELCO-D, VICON, PANASONIC, BOSCH, HONEYWELL, SEC.

* Initial value of communication adjustment

Item	Camera ID	BAUD RATE	UART MODE	PET PKT
Initial value	1	9600	8-NONE-1	ENABLE

- ◆ LANGUAGE : You can select the menu language according to your requirements.
- ◆ RETURN : Select this to save the SPECIAL menu settings and return to the MAIN SETUP menu.
- ◆ PIR Sensor : Built-in PIR sensor makes white LED "ON" when forces somebody's entry as a warning system or function of the light.

WHITE LED		TIME SETUP	
OFF	ON	OFF	ON
1 <input type="checkbox"/>	3 <input type="checkbox"/>	1 <input type="checkbox"/>	3 <input type="checkbox"/>
2 <input type="checkbox"/>	4 <input type="checkbox"/>	2 <input type="checkbox"/>	4 <input type="checkbox"/>
10 SEC		30 SEC	
OFF	ON	OFF	ON
1 <input type="checkbox"/>	3 <input type="checkbox"/>	1 <input type="checkbox"/>	3 <input type="checkbox"/>
2 <input type="checkbox"/>	4 <input type="checkbox"/>	2 <input type="checkbox"/>	4 <input type="checkbox"/>
20 SEC		OFF(DVR Sensor) ON(Alarm:12V Out)	
All OFF 15 SEC			

- switch 1 on → 10sec
- switch 2 on → 20sec
- switch 3 on → 30sec
- switch 4 on → Alarm:12V Out
- switch 4 off → DVR Sensor
- All off → 30sec

● Exit Setting

Select a desired EXIT mode using the Function Setup Switch.

- SAVE : Save the current settings and exit the MAIN SETUP menu.
- NOT SAVE : Do not save the current settings and exit the MAIN SETUP menu.
- RESET : Resets the camera settings to the factory defaults. Language, Communication and Monitor Settings are not initialized.

● Trouble Shooting

PROBLEM	POSSIBLE CAUSE
Nothing appears on the screen.	<ul style="list-style-type: none"> ☞ Check the power cable, power supply output and video connection between the camera and monitor.
The image on the screen is dim.	<ul style="list-style-type: none"> ☞ Are the camera lens or the lens glass dirty? Clean the lens / glass with a soft clean cloth. ☞ Adjust the monitor controls, as required. ☞ If the camera is facing a very strong light, change the camera position. ☞ Adjust the lens focus.
The image on the screen is dark.	<ul style="list-style-type: none"> ☞ Adjust the contrast control of the monitor. ☞ If there is an intermediate device, correctly set the 75Ω/Hi-z.
The camera is not working properly and the surface of the camera is hot.	<ul style="list-style-type: none"> ☞ Check the camera is correctly connected to an appropriate regulated power source.
Motion Detection is not activated.	<ul style="list-style-type: none"> ☞ Has MOTION DET been set to ON in the menu? ☞ Has MD AREA been properly defined?
The colour of the picture is not correct.	<ul style="list-style-type: none"> ☞ Check the settings in WHITE BALANCE menu.
The image on the screen flickers.	<ul style="list-style-type: none"> ☞ Make sure that the camera isn't facing direct sunlight or fluorescent lighting. If necessary, change the camera position.
The SENS-UP does not work.	<ul style="list-style-type: none"> ☞ Check that the AGC setting in the EXPOSURE menu isn't set to OFF. ☞ Check the EXPOSURE menu and make sure SHUTTER is set to-----.

▶ MEMO

▶ MEMO

▶ MEMO

▶ MEMO



GENIE CCTV LTD.

CCTV House, City Park, Watchmead, Welwyn Garden City, Hertfordshire, AL7 1LT

Tel: + 44 (0) 1707 330541 Fax: + 44(0) 1707 330543

www.geniecctv.com

Edition : GN January 2011