

Electromagnetic Lock Installation Instruction (Indoor Series)

Optional Bracket

Identify the door swinging direction and inspect the door frame header to determine if bracket is required. A L- bracket, LZ- bracket or U- bracket (optional) may be required for the electromagnet depending on the frame header and swinging direction.

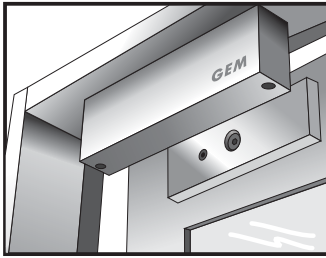

Regular Installation

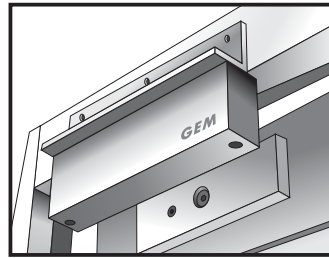

With L-bracket for narrow door frames

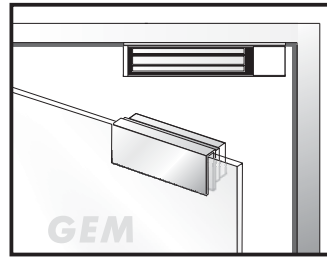

With U-bracket for frameless glass door leaf

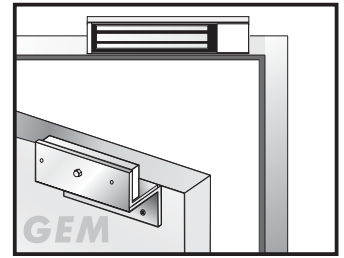

With LZ-bracket for in-swinging door frames

Regular Installation

① Fold the mounting template along the dotted line to a 90-degree angle.

Template

② Close the door, place the template against the door and frame. Drill two holes in the frame and three holes in door as indicated on the template.

③ Drill two holes in the frame and three holes in the door as indicated on the template.

Frame
Door

④ **Armature Plate**
Mounting the armature plate to the door. Actual installation varies according to door style.

⑤ This will allow the armature plate to pivot slightly around the armature screw in order to compensate for door misalignment.

Rubber Washer

⑥ Screw the two self-tapping screws in the slotted holes of the mounting plate and adjust the position of the mounting plate.

<p>Hollow Metal Door</p> <p>12.7mm 8mm</p>	<p>Reinforced Door</p> <p>6.8mm for M8-1.25 thread</p>	<p>Solid Door</p> <p>12.7mm 8mm</p>
---	---	--

Drill an 8 mm hole through door, from sexnut bolt side only, enlarge the 8mm hole to 12.7mm.

Drill an 6.8 mm dia. Hole and tap for M8x12.5 thread.

Drill an 8 mm hole thru door from sexnut bolt side of door, drill 12.7mmhole, 36mm in depth.

Recommendation:
 Micro EM-locks (300 LBS) maximum thickness of door is 44 mm.
 Mini EM-locks (600 LBS) maximum thickness of door is 50 mm.
 Midi EM-locks (800 LBS) maximum thickness of door is 48 mm.
 Standard EM-locks (1200 LBS) maximum thickness of door is 46 mm.

⑦ Once the position is correct, use the screws to permanently mount the mounting plate, And drill the cable access hole.

Cable

⑧ Use the Allen wrench to screw the Fixing screws and Brass Sleeves through the bottom of the electromagnet into the mounting plate.

Allen wrench

⑨ Connect the power lead, and test the unit. Insert the anti-tamper caps into the mounting screw access holes.

Power

Holding Force

With LZ bracket for In-swinging doors

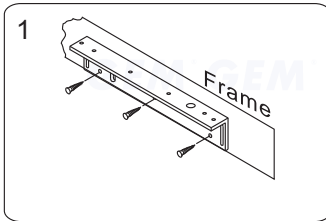

1 Find a mounting location on the door frame for the L bracket. Make sure that the door is still closeable.

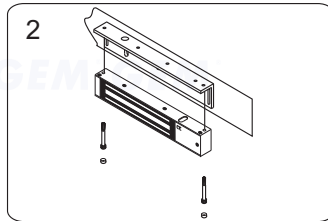

2 Tighten the electromagnetic lock on the L bracket by using the fixing screw.

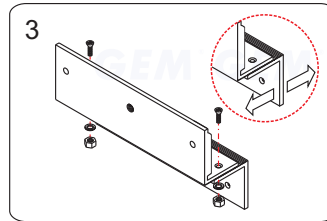

3 Assemble the Z bracket, and make sure that the Z bracket is adjustable.

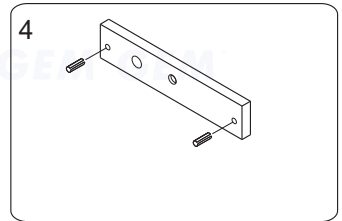

4 Insert the guide pins into the armature plate.

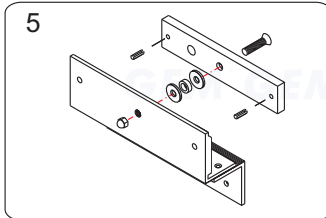

5 Put one rubber washer between armature plate and the Z bracket.

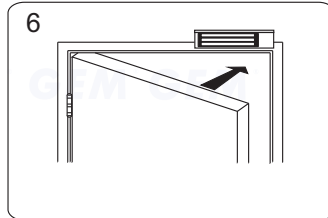

6 Close the door. Measure the correct position by bringing the armature plate close to the contact surface of the electromagnetic lock.

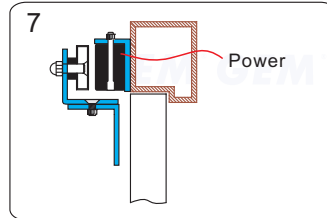

7 Turn on the power of EM-Lock, and let the armature plate bond to the EM-lock. Adjust the position between the Z bracket and the door frame.

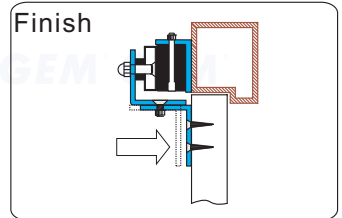

Finish

Once the position is correct, use the screws to permanently mount the Z bracket on the door frame. This should be the last step.

Connecting Diagram

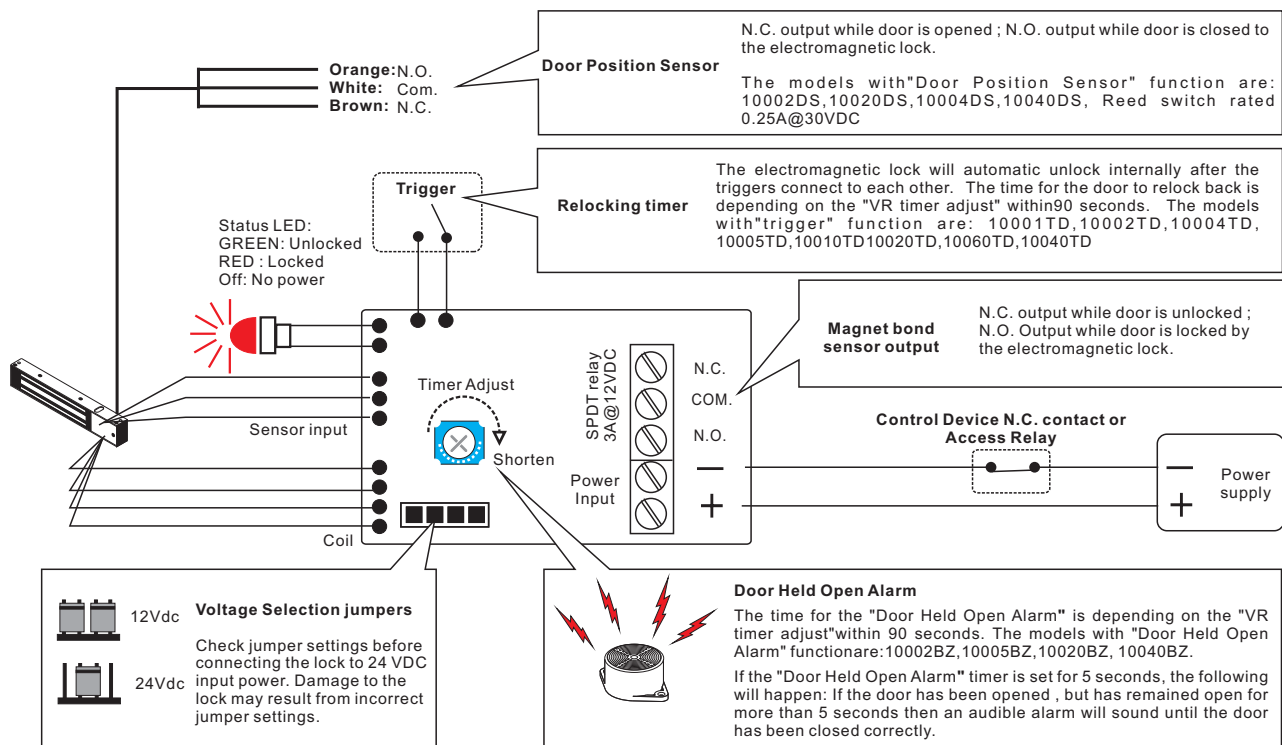

Trouble Shooting

Problem	Possible Cause	Solution
Door does not lock	No power	Check to make sure the wires are securely tightened to the correct terminal block Check that the power supply is connected and operating properly Make sure the lock switch is wired correctly
Reduced holding force	Poor contact between electromagnet and armature plate	Make sure the lock switch is wired correctly. Make sure the electromagnet and armature plate are properly aligned Make sure the contact surfaces of the electromagnet and armature plate are clean and free from dust
	Low voltage or incorrect voltage setting	Ensure the electromagnetic lock is set for the correct voltage. Check for proper voltage at the electromagnetic locks input. If low, determine if the correct wire gauge is being used to prevent excessive voltage drop.
Sensor output is not functioning	A secondary diode was installed across the electromagnet	Remove any diode installed across the magnet for "spike" suppression. (The magnet is fitted with a metal oxide varistor to prevent back EMF)
	Misalignment between the reed switch and its magnet	Check the installation of armature with supplied template.