

The lightning flash with an arrowhead symbol, within an equilateral triangle is intended to alert the user to the presence of uninsulated dangerous voltage within the product's enclosure that may be of sufficient magnitude to constitute a risk of electric shock to persons.



The exclamation point within an equilateral triangle is intended to alert the user to the presence of important operating and maintenance (servicing) instructions in the literature accompanying the appliance.

INFORMATION - This equipment has been tested and found to comply with limits for a Class A digital device, pursuant to part 15 of the FCC Rules & CE Rules. These limits are designed to provide reasonable protection against harmful interference when the equipment is operated in a commercial environment. This equipment generates, uses, and can radiate radio frequency energy and, if not installed and used in accordance with the instruction manual, may cause harmful interference to radio communications. Operation of this equipment in a residential area is likely to cause harmful interference in which case the user will be required to correct the interference at his own expense.

WARNING - Changes or modifications not expressly approved by the manufacturer could void the user's authority to operate the equipment.

CAUTION : To prevent electric shock and risk of fire hazards:

- ◆ Do NOT use power sources other than those specified.

This installation should be made by a qualified service person and should conform to all local codes.

■ Contents

Features	4
Warnings and Precautions	6
Components	8
Names and Functions of Parts	9
■ LENS	10
■ OSD	10
■ VBS-EXTRA	11
■ SMPS	11
■ 3 AXIS BRACKET	11
Dimensions	11
Installation	12
Cable Connection	13

How to Use the Camera	14
■ Menu	14
■ Settings	15
• PRESETS	16
• EXPOSURE	17
• WDR	19
• WHITE BALANCE	20
• DAY&NIGHT	21
• IMAGE ADJ.	22
• SPECIAL	24
- CAMERA ID	25
- VIDEO OUT	26
- DZOOM	26
- MOTION	26
- PRIVACY MASK	27
- SYNC	28
- RESET	28
• EXIT MEMU	29
Troubleshooting	30
Specifications	32

■ Features

High Resolution Colour for Crisp, Clear Video

- Progressive image capture
- 690TVL Effective

Wide Dynamic Range (WDR)

The camera delivers clear high quality pictures, even when backlit, by increasing exposure in dark areas while decreasing it in bright areas; a corrected image with clear details results.

- 120dB maximum dynamic range

DNR (Digital Noise Reduction)

The amount of low illuminance noise has been significantly reduced, and the signal-to-noise ratio (S/N ratio) as well as horizontal resolution, have been improved resulting in a clear and sharp image even in low light.

Day & Night

The camera identifies whether it is day or night and automatically switches to the appropriate mode, depending on its environment. By day, the camera switches to colour mode in order to maintain optimal colour. At night, it switches to B/W mode so as to obtain better picture definition.

High Sensitivity for low-light images

The built-in high sensitivity PIXIM SEAWOLF Sensor enables a clear image even at 0.1Lux

Motion Detection

Since the camera detects motion without any additional external sensor, you can monitor activity more efficient.

Programmable GAMMA Processing

Controlled by OSD Menu

The camera can be controlled by selecting text displayed on the monitor screen.

Additional Functions

SYNC (INT/LL), SENS-UP, FREEZE, FLIP (H/V-REV), D-ZOOM, SHARPNESS and PRIVACY functions are provided.

3 Axis built-in Vandal Resistant Dome Housing

Weatherproof (IP67)

Warning ■

The camera requires periodic inspection.

Contact an authorised technician to carry out the inspection.

Stop using your camera when you find it malfunctioning.

If the camera emits smoke or is unusually hot for a long period, a fire may be caused.

Do not install the camera on a surface that can not support it.

If the camera is installed on an inappropriate surface, it may fall and cause injury.

Do not hold plug with wet hands.

It could cause an electric shock.

Do not dis-assemble the camera.

It may result in an electric shock or other hazards.

Do not use the camera close to a gas or oil leak.

It may result in a fire or other hazards.

■ Precautions

Do not install the camera in extreme temperature conditions.



Only use the camera under conditions where temperatures are between -10°C and $+50^{\circ}\text{C}$. Be especially careful to provide ventilation when operating under high temperatures.

Do not install or use the camera in an environment where the humidity is high.



It can cause the image quality to be poor.

Do not install the camera under unstable lighting conditions.



Severe lighting change or flicker can cause the camera to work improperly.

Do not touch the front lens of the camera.



This is one of the most important parts of the camera. Be careful not to leave fingerprints on the lens cover.

Do not drop the camera or protect it from physical shocks.



It can cause malfunctions to occur.

Do not expose the camera to radioactivity.



If exposed to radioactivity the CMOS will fail.



Note

- If the camera is exposed to spotlight or an object reflecting strong light, smear or blooming may occur.
- Please check the power supply satisfies the normal specification before connecting the camera.

■ Components

1. COLOUR DOME CAMERA

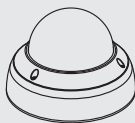

2. SCREWS

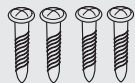

3. WRENCH

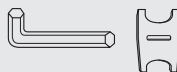

4. WIRE FOR VBS-EXTRA



5. INSTRUCTION GUIDE



Names and Functions of Parts ■

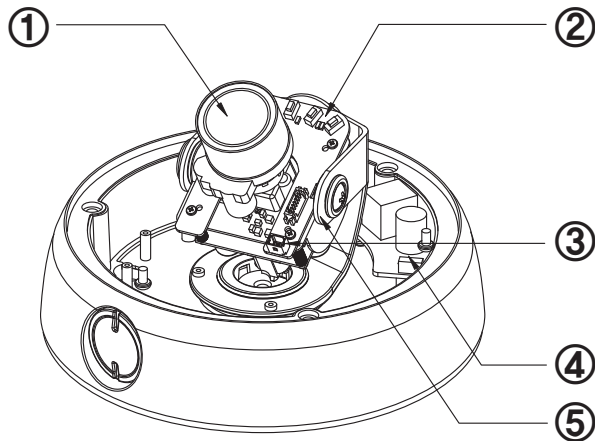

Names and Functions of Parts

① LENS : Vari-Focal DC Auto Iris Lens

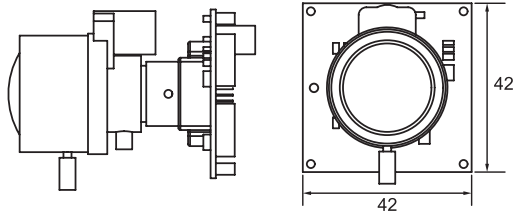

② OSD PCB

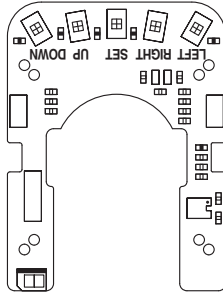

- **SET button** : Used for the menu display. This button can be used to confirm settings after changing the value of the selected function or current conditions.
- **UP & DOWN buttons** : Used for selecting items by moving the cursor up or down on the menu screen.
- **LEFT & RIGHT buttons** : Used when changing item values, by moving the cursor to the left or right on the menu screen.

Names and Functions of Parts

③ VBS-EXTRA FOR CONNECTING TO LCD

Please use the supplied wire when connecting to an external monitor.

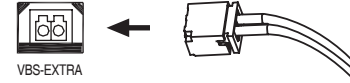

④ SMPS PCB FOR DUAL POWER - IF APPLICABLE

⑤ 3 AXIS BRACKET

Please loosen screws and fix tilted and panned position.

Dimensions

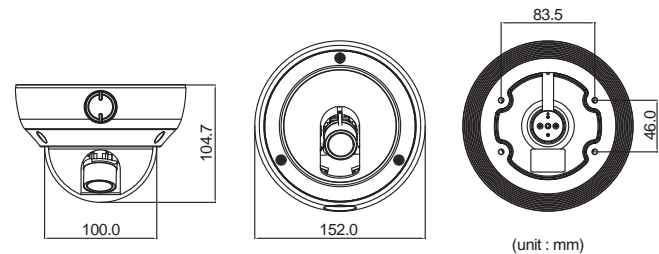

■ Installation

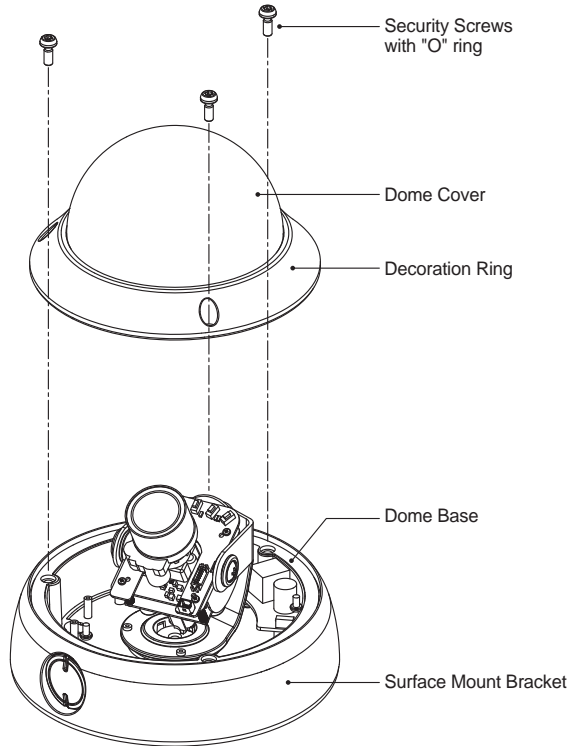

1. Dome Base Mounting

- Open the dome cover by loosening the 3 screws using the special wrench provided.
- Mount the base of camera to a sturdy surface using the 4 screws (1.5 inch) and the 4 premade holes on the base of the dome.

2. Power Connection & Monitor Impedance

- DC12V/300mA regulated power supply (DC12V only)
- AC24V Class 2 power supply (AC24V/DC12V)
- To avoid fire or shock hazard, always use a CE listed power supply.
- Set the monitor impedance switch to 75Ω. Check the impedance switch if the screen appears blurred.

3. Camera Module Adjustment

- Loosen screws for the 3-axis camera bracket to adjust the cameras angle of view.
- Make sure to retighten the camera bracket screws.
- Use the OSD buttons to select the different camera functions.

4. Dome Cover Mounting

- Replace the dome cover to the base and tighten the 3 screws.

Cable Connections ■

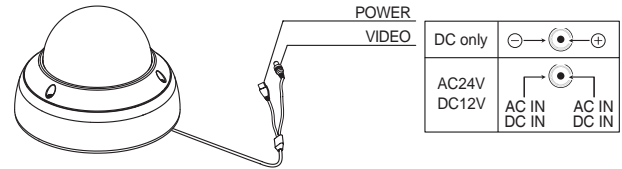

How to Use the Camera

Menu

SETUP menu			
PRESETS	· NORMAL · BACKLIGHT	· INDOOR	· OUTDOOR
EXPOSURE	· LENS SELECT · EXPOSURE MODE · DNR · COLOR ROLL		· BLC · AGC · HIGHLIGHT · SENS-UP
WDR	· MIDDLE · LOW	· HIGH	· USER
WHITE BALANCE	· ATW · AWB	· INDOOR · MANUAL	· OUTDOOR
DAY&NIGHT	· AUTO	· COLOR	· BW
IMAGE ADJ.	· FREEZE · COLOR GAIN	· FLIP · GAMMA	· SHARPNESS · FOCUS
SPECIAL	· CAMERA ID · MOTION · RESET	· VIDEO OUT · PRIVACY MASK	· DZOOM · SYNC
EXIT MENU	· VERSION · CANCEL	· SAVE&EXIT	· DEFAULT

Settings

Settings can be made using the 5 buttons located in the camera.

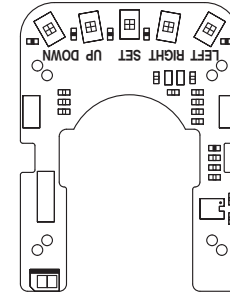

1. Press the SET button
 - Settings can now be made. The SETUP menu is displayed on the monitor.

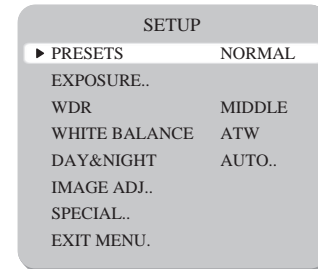

2. Select a menu item from the list available by using the UP and DOWN buttons.
 - Functions are selected using up and down buttons.
 - The selected position is displayed in blue.

How to Use the Camera

Select the function using the UP or DOWN button.

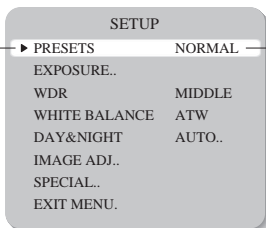

Change the status using the LEFT or RIGHT button.

- Set up a selected item by using the Left and Right buttons.
- To finish and save the settings, select 'EXIT MENU' and press the SET button.



Note

- An item with the .. icon also has sub-menus. To select a sub-menu, press the SET button.

PRESETS

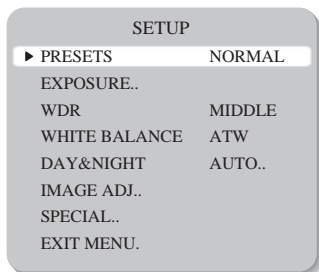

- **NORMAL** : Normal environment.
- **INDOOR** : Indoor environment.
- **OUTDOOR** : Outdoor environment.
- **BACKLIGHT** : Backlight environment.

EXPOSURE

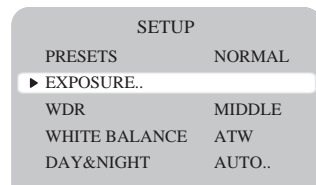

When the SETUP menu screen is displayed, select 'EXPOSURE' by using the Up and Down buttons so that the arrow indicates 'EXPOSURE'.

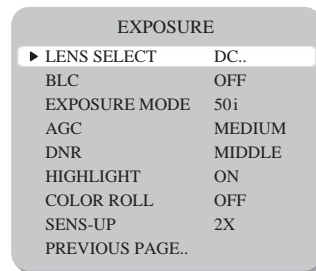

- **LENS SELECT** : Using this function, you can control the screen brightness.
 - DC / Manual : Select Lens Type.

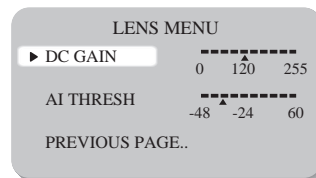

How to Use the Camera

- **BLC** : To optimize the scene when there is a strong backlight behind the object.
 - ON / OFF selectable

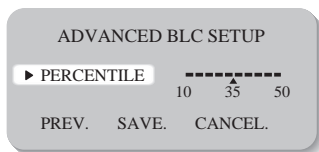

- **EXPOSURE MODE** : To select the number of fields and number of exposure cycles.
 - 50i/25p selectable
- **AGC (AUTO GAIN CONTROL)** : In dark environments, the higher the gain level, the brighter the screen but the higher the noise.
 - OFF / LOW / MEDIUM / HIGH selectable
- **DNR (Digital Noise Reduction)** : The level of background noise in low light decreases automatically as the level of gain changes.
 - OFF / LOW / MIDDLE / HIGH selectable
- **HIGHLIGHT** : To optimise the scene when high dynamic range lighting is detected.
 - ON : bright parts of the image are most visible.
 - OFF : dark parts of the image are most visible.
- **COLOR ROLL** : To control a detector that finds colour fluorescent roll.
 - OFF / LOW / HIGH selectable
- **SENS-UP** : When it is night or dark, the camera automatically detects the light level and maintains a clear picture if this mode is activated.
 - 2X, 4X, 8X, 16X, 32X
 - OFF : Deactivates the SENS-UP function.

WDR

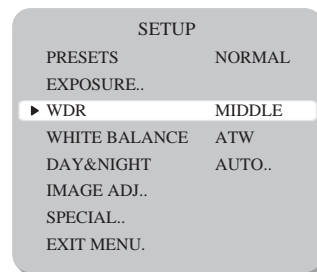

- **WDR** : When the image has simultaneous bright and dark areas, the Wide Dynamic Range makes both areas distinct.
 - LOW / MIDDLE / HIGH / USER selectable

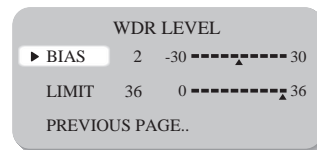

How to Use the Camera

WHITE BALANCE

Use the White Balance function to adjust the screen colours.

1. Position the cursor to point to **WHITE BAL** on the **SETUP** menu screen, select using the Up and Down buttons.
2. Select the desired mode using the Left and Right buttons.

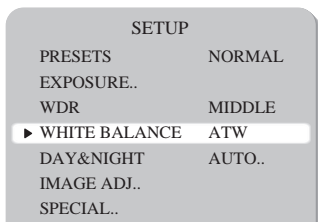

※ Select one of the following 5 modes, as appropriate.

- **ATW** : The ATW mode continuously monitors.
- **INDOOR** : Select when the colour temperature is between 4000°K and 8500°K
- **OUTDOOR** : Select when the colour temperature is between 2000°K and 11000°K
- **AWB** : To obtain the optimum state under the current luminance levels, direct the camera to point toward a sheet of white paper and press the SET button. If the environment changes, including the light source, the white balance will require re-adjustment.
- **MANUAL** : Select to "fine-tune" the White Balance manually. Set White Balance first using the ATW or AWB mode. Afterwards switch to **MANUAL** mode, fine-tune the White Balance and then press the SET button.

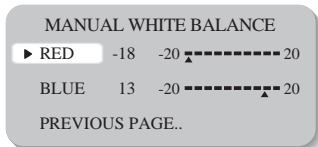

Note

• Under the following conditions White Balance may not work properly. In such cases, select the AWC mode.

- ① When the colour temperature of the subject environment has a very high temperature range (e.g. clear sky, or sunset)
- ② When the ambient illumination of the subject is low.
- ③ If the camera is directed toward a fluorescent light, or is installed in a place where illumination changes dramatically, the White Balance operation may become unstable.

DAY&NIGHT

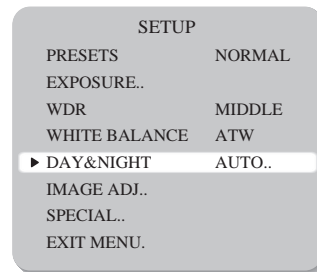

- **AUTO** : This camera has a function which automatically changes to the appropriate mode according to lighting levels. To set up the switching time for the AUTO mode press the SET button.

How to Use the Camera

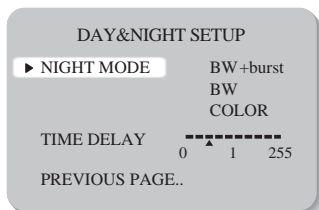

- **COLOR** : The picture is displayed in colour.
- **BW** : The picture is always displayed in black and white.

IMAGE ADJ.

When the SETUP menu screen is displayed, select 'IMAGE ADJ.' using the Up and Down buttons.

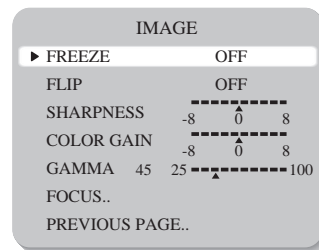
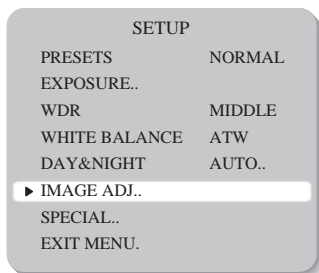

- **FREEZE** : View still pictures.
 - OFF / ON selectable
- **FLIP** : OFF / HORIZ / VERT / BOTH selectable

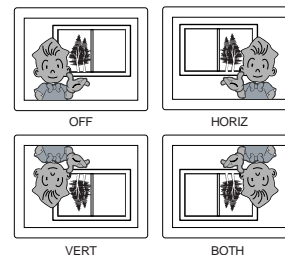

- **SHARPNESS** : The outline of the video image becomes cleaner and more distinctive as the level of SHARPNESS increases. If the level goes up excessively, however, it may affect the video image and generate noise.
 - The available range of level is -8 ~ 8
- **COLOR GAIN** : To control the colour level in the video.
 - The available range of level is -8 ~ 8
- **GAMMA** : Users can change the gamma setting between 25 and 100

How to Use the Camera

- **FOCUS** : To adjust the lens focus.

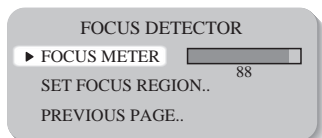

SPECIAL

When the SETUP menu screen is displayed, select 'SPECIAL' by using the Up and Down buttons so that the arrow indicates 'SPECIAL'.

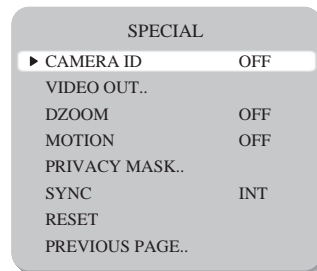
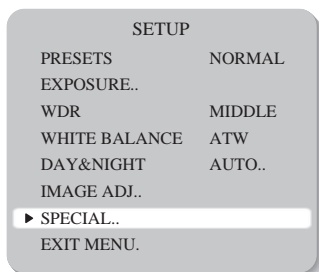

- **CAMERA ID** : User can enter a unique name for the respective camera. The maximum length of the ID is ten characters.
 - You can choose the ON and OFF with the selector. If you select ON, the entered camera ID is displayed at the selected position in the video picture (normal operation).
 - Please select the setup button while in On mode.
 - Select the desired position with the selector.

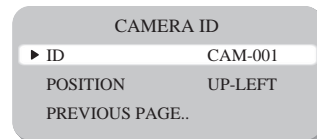

- ① Move the cursor to the letter required by using the Set-Up button.
- ② Select an ID from A,B-Y,Z, a,b-y,z, 0,1-8,9 by using the LEFT and RIGHT buttons.
- ③ Repeat the above steps until the ID is complete.

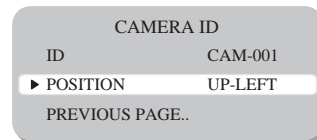

How to Use the Camera

- ① Select the position where the ID is to be displayed by using the LEFT and RIGHT buttons.

- **VIDEO OUT** : Move the cursor to select the video system
 - VIDEO STANDARD : You can control NTSC / PAL, Video level, Sync level, Burst level.

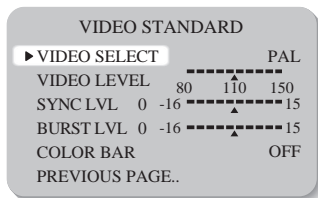

- **DZOOM** : Digital P/T/Z are used to create a zoom lens effect. Zoom Factor (1X to 4X), Pan ($\pm 100\%$, center of image can be moved to left and right edges of screen), Tilt ($\pm 100\%$, center of image can be moved to top and bottom edges of screen)

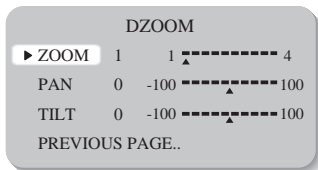

- **MOTION** : This product has a feature that allows you to observe movements of objects in on the screen, hence a single individual can conduct supervision efficiently. The camera detects an object's movement by sensing disparity of outline, and level of brightness and colour.

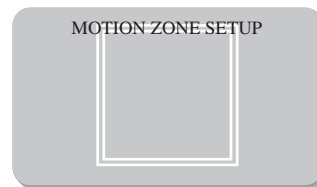
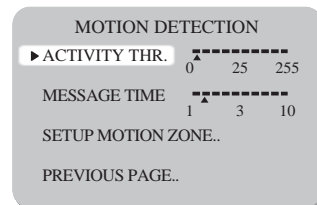

- White : MOTION ZONE Position movement
- Green : MOTION ZONE Size enlargement
- Red : MOTION ZONE Size reduction
- For MOTION ZONE Confirm, long press SET button

- **PRIVACY MASK** : Hide an area you want to hide on the screen.

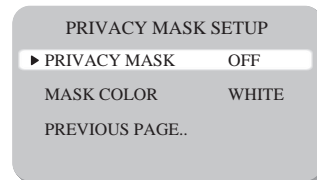

■ How to Use the Camera

ENABLE MASKS (1 to 6)

▶ MASK 1	ON
MASK 2	OFF
MASK 3	OFF
MASK 4	OFF
MASK 5	OFF
MASK 6	OFF
PREV. NEXT.	

ENABLE MASKS (7 to 12)

▶ MASK 7	OFF
MASK 8	OFF
MASK 9	OFF
MASK 10	OFF
MASK 11	OFF
MASK 12	OFF
PREVIOUS PAGE..	



- White : PRIVACY-ZONE Position movement
- Blue : PRIVACY-ZONE Size enlargement or reduction
- For PRIVACY-ZONE Confirm, long press SET button

- **SYNC** : Two synchronisation modes are available, INTERNAL and EXTERNAL LINELOCK. In LINE-LOCK mode, it synchronises the video signal between cameras without a synchronous generator. The line-lock synchronisation is only used in areas of 60Hz (NTSC) / 50Hz (PAL).

- INT : Internal synchronisation
- LL : External line-lock synchronisation
 - If 'LL' is selected, it can be adjusted to the desired phase. Press the SET button.

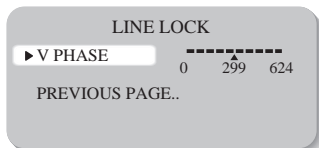

- Adjust to the desired phase from 0 to 624.

- **RESET** : Resets the camera.

EXIT MENU.

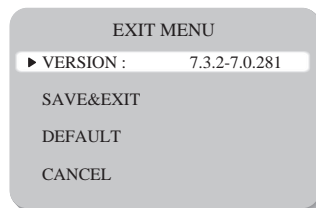

- **VERSION** : 7.3.2-7.0.281
- **SAVE&EXIT** : Saves all the setting menus and then exits.
- **DEFAULT** : Resets the camera settings to the factory defaults.
- **CANCEL** : Cancel to the camera settings.

■ Troubleshooting

If you have trouble operating your camera, refer to the following table. If the guidelines do not enable you to solve the problem, contact an authorised technician.

Problem	Solution
Nothing appears on the screen.	<ul style="list-style-type: none">• Check the power connections.• Check the VIDEO signal line connection.
The image on the screen is dim.	<ul style="list-style-type: none">• Make sure the lens is clean. Clean the lens with a soft clean lint free cloth.• Adjust the monitor contrast & brightness controls.• Re-position the camera if necessary.
The image on the screen is dark.	<ul style="list-style-type: none">• Adjust the contrast control of the monitor.• If you have an intermediate device, set the 75Ω/ Hi-z properly.
The camera is not working properly, and the surface of the camera is hot.	<ul style="list-style-type: none">• Check that an appropriate power source is connected to the camera.
The Motion Detection function does not work.	<ul style="list-style-type: none">• Check that MOTION DET in the SPECIAL SETUP is not set to 'OFF'.

Problem	Solution
Colour is not correct.	<ul style="list-style-type: none">• Check the WHITE BAL settings in the SETUP menu.
The screen flickers continually.	<ul style="list-style-type: none">• Check that the camera is not facing toward the sun.

■ Specifications

ITEM	SPEC.
Power Consumption	170mA (AC24V) / 250mA (DC12V) 160mA (DC12V Only)
Image Sensor	PIXIM 1/3" High Sensitivity Digital Sensor
Signal processing	17-bit Digital Signal Processing
Transfer Format	Progressive with Segmented Frames
Sync. System	Internal / Line Lock
Effective Pixels	758(H) x 540(V)
Lens	Tamron 2.8mm ~ 10.5mm DC AI VF Lens
Horizontal Angle of View	93.7° ~ 28.3°
Dynamic Range	120dB(Max), 102dB(Typical)
Horizontal Resolution	690TVL Effective
Min. Illumination	0.1Lux
Day & Night	AUTO / COLOR / B/W
White Balance	ATW / AWB / INDOOR / OUTDOOR / MANUAL
WB Range	2000°K~11,000°K
Shutter Speed	up to 1/30, 720 sec
Sens-up	AUTO / OFF (Selectable x2 ~ x32)
Privacy Masking	12 Zones
AGC	OFF / LOW / MEDIUM / HIGH
Image Flip	OFF / HORIZ / VERT / BOTH
Camera ID	ON / OFF
S/N Ratio	More than 50dB
Video Output	Composite video output 75 ohm terminated
OSD	Built-in
Operating Humidity	30% ~ 90% RH
Operating Temp.	-10°C to 50°
Weatherproof	IP67
Weight	Approx. 1,100g

※ POWER OPTION - DC12V Only : VRD83SPX/12



Model : VRD83SPX
VRD83SPX/12

PIXIM Digital Day/Night Vandal Resistant Dome Camera

Instruction Guide



GENIE CCTV LTD.

CCTV House, City Park, Watchmead, Welwyn Garden City, Hertfordshire, AL7 1LT

Tel : +44 (0) 1707 330541 Fax : +44 (0) 1707 330543

www.geniecctv.com

Edition. GN-OCTOBER 2011