



Model: VRD73IR

True Day/Night Vandal Resistant IR Dome Camera

User Guide



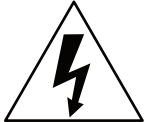

The lightning flash with an arrowhead symbol, within an equilateral triangle is intended to alert the user to the presence of uninsulated dangerous voltage within the product's enclosure that may be of sufficient magnitude to constitute a risk of electric shock to persons.



The exclamation point within an equilateral triangle is intended to alert the user to the presence of important operating and maintenance (servicing) instructions in the literature accompanying the appliance.

INFORMATION - This equipment has been tested and found to comply with limits for a Class A digital device, pursuant to part 15 of the FCC Rules & CE Rules. These limits are designed to provide reasonable protection against harmful interference when the equipment is operated in a commercial environment. This equipment generates, uses, and can radiate radio frequency energy and, if not installed and used in accordance with the instruction manual, may cause harmful interference to radio communications. Operation of this equipment in a residential area is likely to cause harmful interference in which case the user will be required to correct the interference at his own expense.

WARNING - Changes or modifications not expressly approved by the manufacturer could void the user's authority to operate the equipment.

CAUTION: To prevent electric shock and risk of fire hazards. Do NOT use power sources other than those specified.

This installation should be made by a qualified service person and should conform to all local codes.

Contents

Dimensions	5
Package Contents	5
Focus Adjustment	6
Installation	7
General Features	8
Precautions	9
Safety Instructions	10
Menu Set Up	11
• OSD Control Keys	11
• Set Up Menu	12
• Menu Set Up	14
• Lens	15
• Exposure	17
• White Balance	18
• D-WDR/HSBLC	19
• 3D-DNR	22
• Day/Night	22
• Smart-IR	24
• Special	25
• Camera Title	25
• Adjust	28
• Mirror	31
• Motion Detection	32
• Privacy	33
• Sync	34
• Resolution	35
• Reset	35
• Return	35
Exit	36
Specification	37
Troubleshooting	38

Camera Dimensions

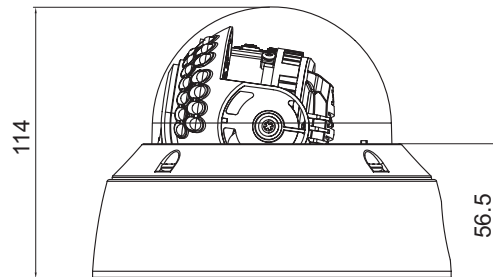
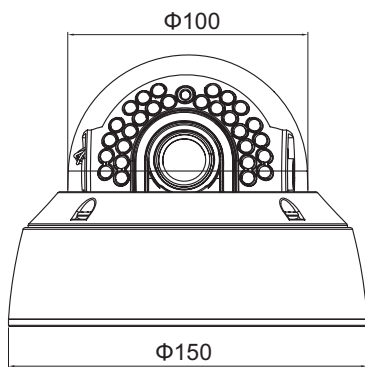
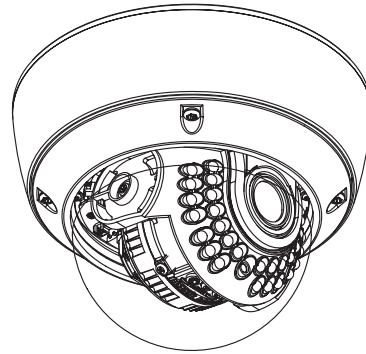
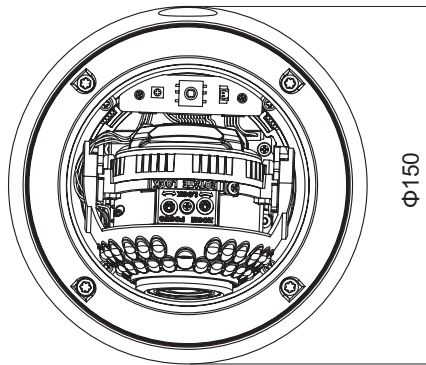

Package Contents

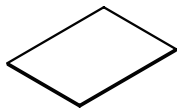

INSTRUCTION MANUAL 1EA

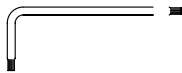

TORK WRENCH T20 1EA



FOCUS CONTROL SCREW 1EA

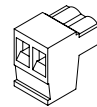

GREEN TERMINAL 2P MAIL 1EA

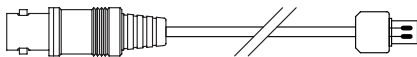

VIDEO TEST CABLE 1EA

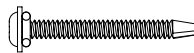

SCREW TS T1, #8X38 & O-RING ASSY 4EA



SCREW PH M4X8, BK, 3EA

Focus Adjustment

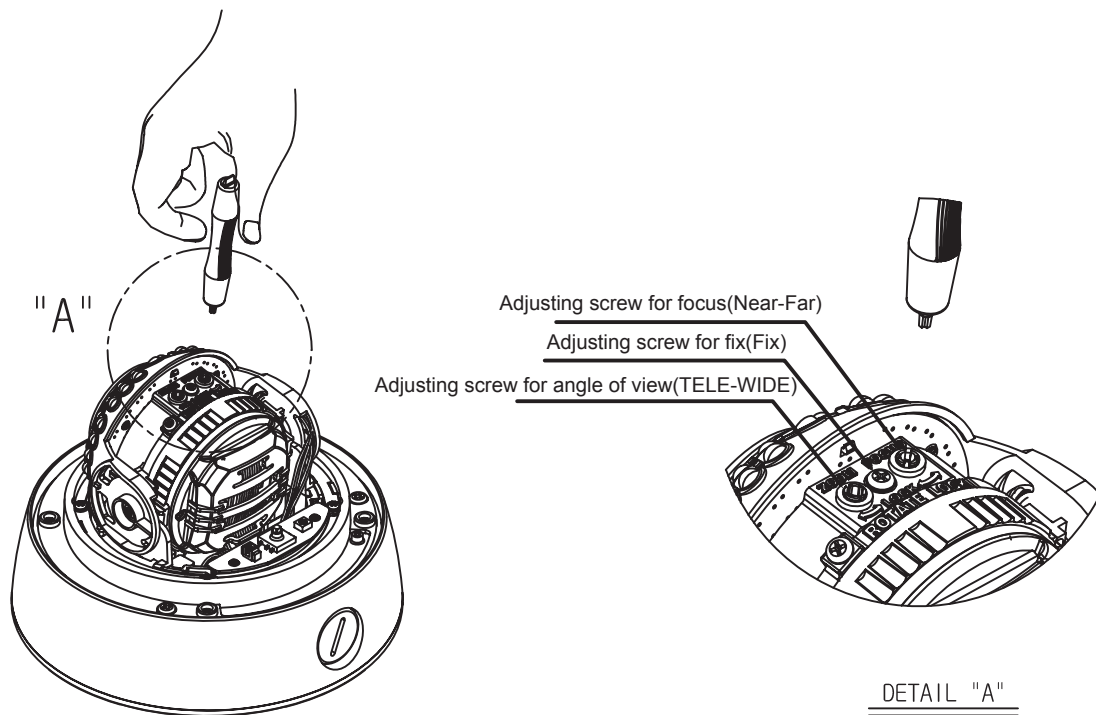

- 1) Loosen the screw in the middle.
- 2) Adjust angle of view by using the controller.
- 3) Adjust focus by using the controller.
- 4) Tighten the screw in the middle.

Camera + Installation

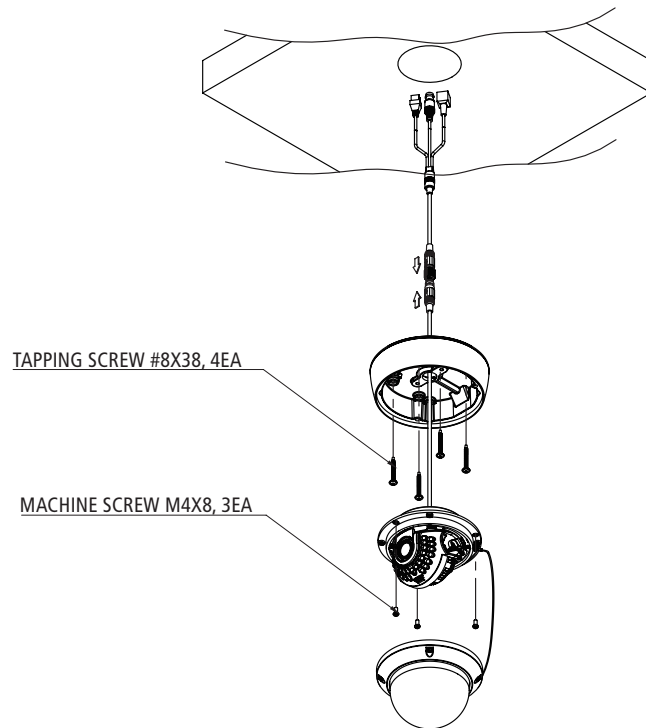

Cable Connection

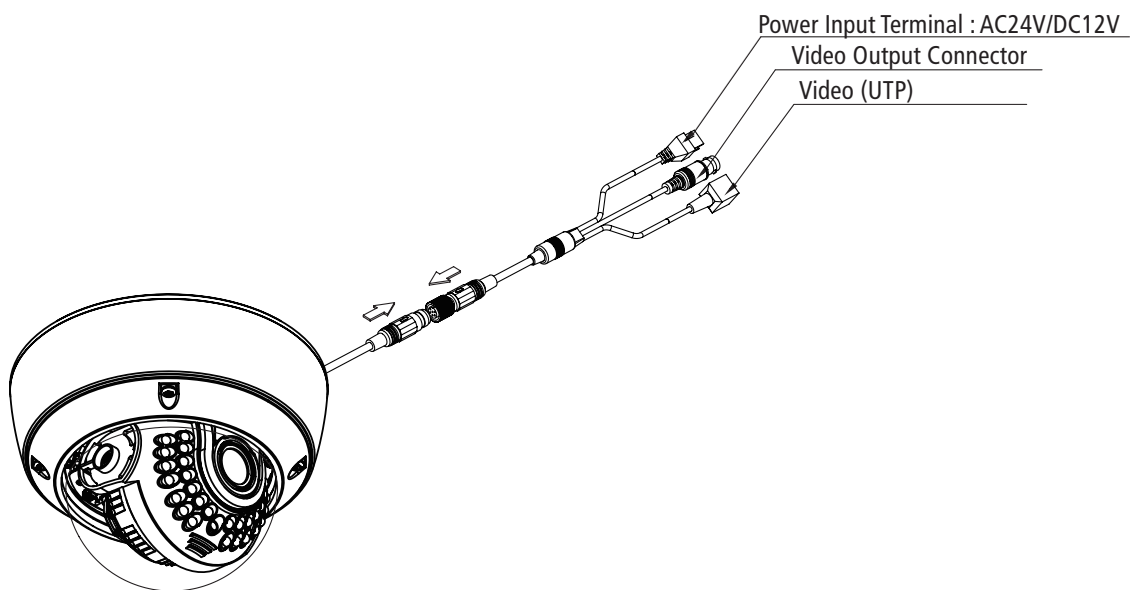

General Features



Presets

Presets (Outdoor, Indoor, Elevator, Lobby, Hallway & Low Light). Used for a quick and easy setup according to the prevailing installation environment.



3D Motion DNR Function

When movements in the picture are detected, 3D-DNR AUTO can reduce the level of noise; with a low-level DNR setting. Oppositely, if there are no moving picture elements, noise can be reduced using a high-level DNR setting.



620 TV Lines

The combination of a Sony Super HAD CCD image sensor and a DNR DSP provides an excellent resolution of 620 TV lines.



D-WDR (Digital Wide Dynamic Range)

D-WDR is a powerful and ultra advanced technology that captures cleaner and superior high Resolution pictures, even where images appear dark due to a strong backlight presence.



Auto Defect

When set to AUTO this function corrects black and white dots caused by pixel failure, in real time, when Sens Up is on. When changing from OFF to AUTO, you will see the reduction in pixels which are permanently on (white dot) and those permanently off (black dot).



Smart-IR (IR Models Only)

No Image Saturation. Vivid Images in Darkness. "Smart IR" gives a very sharp video image in darkness. This technology eliminates video image IR saturation of close objects by controlling the IR sensitivity.

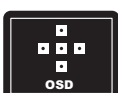

Additional Functions

OSD - On Screen Display menu with multi-language support.

Privacy Masking - 8 Zones

Sens-Up - x1024

Precautions

Do not install the camera in extreme temperature conditions.

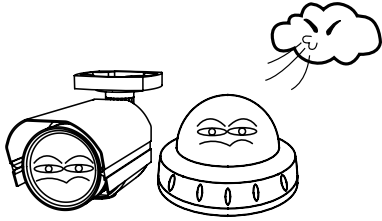

Only use the camera under conditions where temperatures are between -20°C and +50°C. Be especially careful to provide ventilation when operating under high temperatures.

Do not install or use the camera in an environment where the humidity is high.

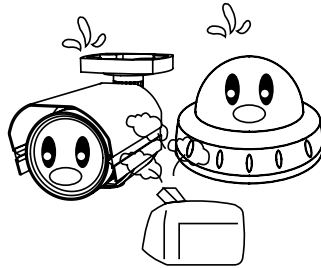

Do not install or use the camera in an environment where the humidity is high.

Do not install the camera under unstable lighting conditions.

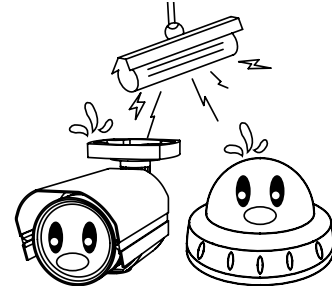

Severe lighting change or flicker can cause the camera to work improperly.

Do not touch the front lens of the camera.

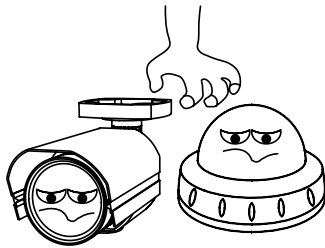

This is one of the most important parts of the camera. Be careful not to leave fingerprints on the lens cover.

Never keep the camera pointed directly at strong light.

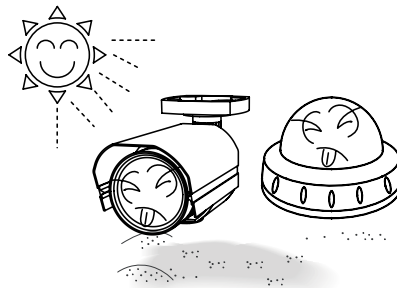

It can cause malfunctions to occur.

Do not drop the camera or subject it to physical shocks.

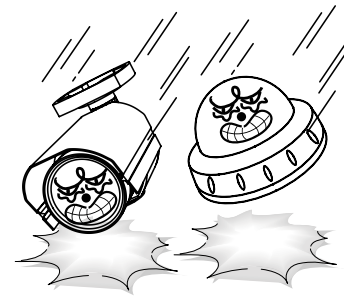

Housing damage can compromise weatherproof ratings.

Do not expose the camera to radioactivity.

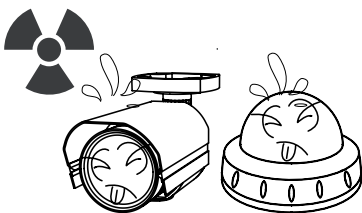

If exposed to radioactivity the CCD will fail.

NOTE

* If the camera is exposed to spotlight or object reflecting strong light, smear or blooming may occur.

* Please check that the power satisfies the normal specification before connecting the camera.

Safety Instructions

Precautions for use:

This camera should be installed by a qualified person only.

There are no user serviceable parts inside.

Do not disassemble this camera other than to make initial adjustments.

Only use a CE approved regulated DC12V, or AC24V power supply.

Use appropriate low voltage power cable to prevent fire or electrical shock.

Please ensure that your installation area can support the weight of the camera.

Please handle this camera carefully:

Do not use strong or abrasive detergents when cleaning the camera.

Only use soft non-abrasive materials to clean the polycarbonate dome.

Do not expose the camera to direct sun.

Do not install the camera in places where humidity is high.

Do not install near cooling or heating devices.

OSD Control Keys

1. Control Keys are used to access and operate the OSD menu.

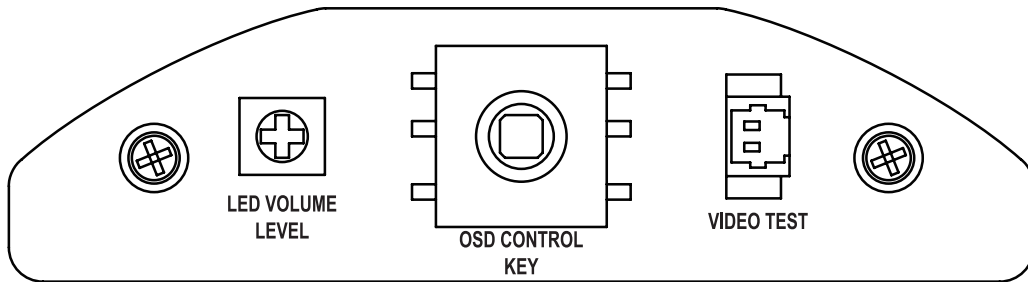

How to Set Up the camera menu

- PRESET MODE OSD MENU

MAIN SETUP						
PRESET MODE	INDOOR	OUTDOOR	LOW LIGHT	HALLWAY	LOBBY	ELEVATOR
ADVANCED ←↑						
EXIT ↓						

DEFAULTS OF PRESET MODE						
	INDOOR	OUTDOOR	LOW LIGHT	HALLWAY	LOBBY	ELEVATOR
SENS-UP	x8	x16	x32	x8	x8	x8
D-WDR	OFF	OFF	OFF	OFF	ON (10)	OFF
HD-DNR	HIGH	AUTO	AUTO	AUTO	AUTO	AUTO

ADVANCED SETUP	DEFAULT SET	MENU	
LENS	DC	BRIGHTNESS (23 Adjustable)	
		E. SHUTTER	1/50
		RETURN	
EXPOSURE	AGC	HIGH	
		OFF	
		LOW	
		MIDDLE	
	SENS-UP	Defaults for Preset Mode	
	RETURN		
WHITE BALANCE	ATW		
	MANUAL	M-WR	64
		M-WB	64
		RETURN	
	AWC ->SET		
D-WDR/HSBLC	OFF		
	BLC	BLC LEVEL	MID
		TOP	04
		BOTTOM	11
		LEFT	04
		RIGHT	11
		RETURN	
	HSBLC	HBLC	MANUAL
		MODE	ALL DAY
		HLM LEVEL	010
		MASK1	ON
		MASK2	ON
		MASK3	ON
		MASK4	ON
RETURN			
D-WDR	SET LEVEL	10	
	RETURN		
3D-DNR	AUTO		
	OFF		
	LOW		
	MID		
DAY/NIGHT	HIGH		
	COLOUR (IR LED NO)		
	B/W		
	EXT (IR LED)	BURST	OFF
		DELAY TIME	004
		RETURN	
	AUTO (IR LED/NO TDN LENS)	BURST	OFF
		DAY>NIGHT	021
NIGHT>DAY		009	
DELAY TIME		002	

		RETURN			
SMART-IR	OFF/ON	SET LEVEL	070		
		RETURN			
SPECIAL	CAMERA TITLE	OFF			
		ON			
	ADJUST	SHARPNESS:15			
		MONITOR: LCD/CRT			
		GAMMA: 0.55/0.65/USER/0.45			
		LSC: OFF/ON	SET LEVEL	010	
			RETURN		
		LANGUAGE	ENGLISH/RUSSIAN/SPANISH/ITALIAN/FRENCH/ TURKISH/CHINESE1/CHINESE2/KOREAN/JAPANESE		
		COMMUNICATION OFF/ON	ID	001	
			BAUD RATE	9600 BPS	
			PROTOCOL	PELCO-D	
			RETURN		
		DEFECT: AUTO/OFF	WHITE THR	150	
	LUMA THR		030		
		RETURN			
		RETURN			
	MIRROR	OFF/ON			
	MOTION DET	OFF/ON	ALARM	ON/OFF	
			AREA	AREA 1~4	
			SENSITIVITY	025	
			DISPLAY	OFF	
			HOLD TIME	003	
		RETURN			
	PRIVACY	OFF/ON	MASK1	ON/OFF	
			MASK2	ON/OFF	
			~	~	
		MASK8	ON/OFF		
SYNC	INT				
	L.L	ADJUST	100		
		RETURN			
RESOLUTION	NORMAL/HIGH				
RESET	NO/YES				
RETURN					
RETURN					

Menu Set Up

Menu items can be selected using the camera OSD buttons

1. PRESET



1-1. Preset: INDOOR / OUTDOOR / LOW LIGHT / HALLWAY / LOBBY / ELEVATOR.

- Used for a quick and easy setup for the prevailing installation environment.

* The Advanced Set Up Menu will be displayed on the monitor.

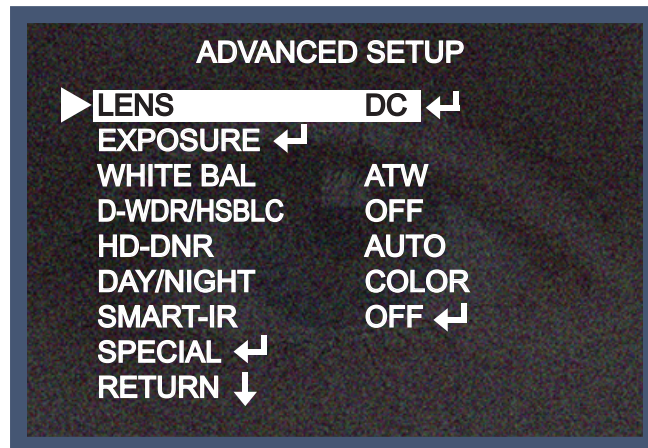

2. Move and select the required function using the Up and Down buttons.

* Move the arrow indicator up or down to select the desired feature by pressing the Up and Down buttons.

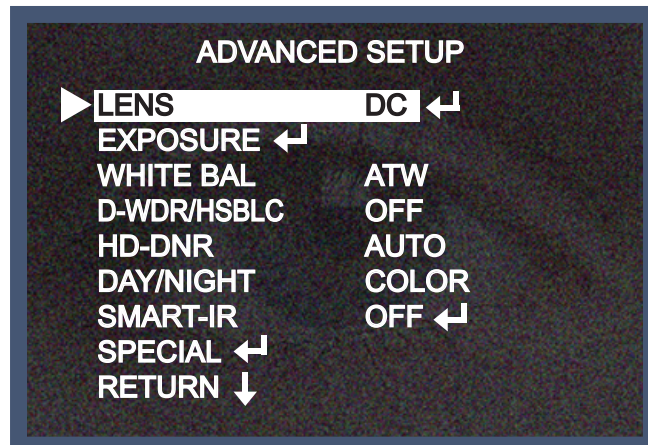

3. Change menu settings using the Left or Right buttons.

* Available values or status's are displayed by pressing the Left or Right buttons.

Press the button until desired value / status is displayed.

4. After changing the setting, move the arrow indicator to EXIT and press the SET button to EXIT.

NOTE

* Move to the available submenu by moving  arrow to desired feature.

* Submenu is not available when this symbol is displayed "- - - -"

Lens

1. Move the arrow indicator to LENS using the Up and Down buttons on the Set Up menu screen.

2. Select the desired lens type by pressing the Left or Right buttons.

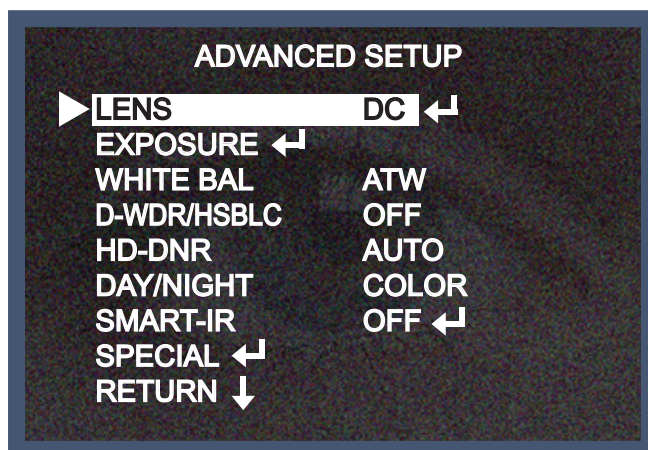

 DC:DC Auto Iris Lens

NOTE

* When DC is selected, the brightness can be adjusted. The brightness control range is 1 ~ 100.

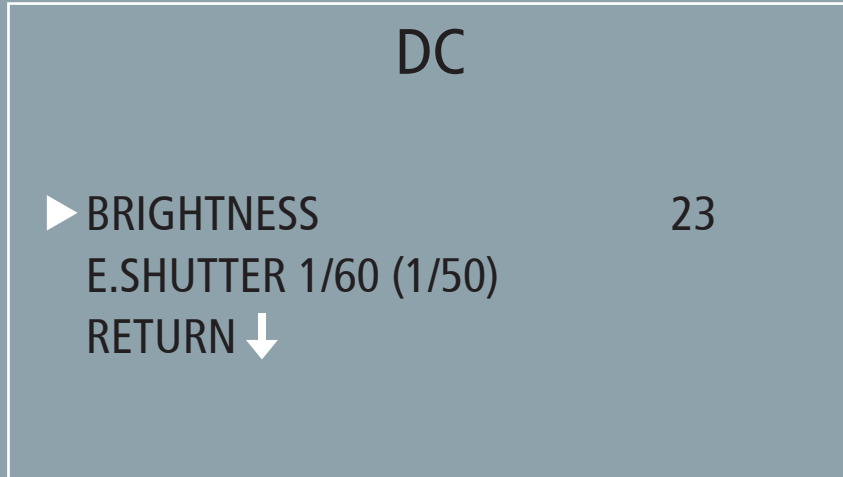

3. Select the desired shutter mode by pressing the Left or Right buttons.

4. Press RETURN to return to the SETUP menu.

* FLK: Select FLK mode when flickering occurs; usually caused by the unmatched frequency of electric lights.

NOTE

*Shutter: Select Shutter using the Up or Down buttons, you can adjust the shutter speed from 1/60 (1/50), FLK, 1/250~1/100,000.

→FLK: Select FLK mode if flickering occurs; usually caused by the unmatched frequency of electric lighting. If select FLK mode, Sens-Up does not operate.

Exposure

This function is used to select Sens-Up or Auto Gain Control.

1. On the Set Up menu screen select EXPOSURE using the Up or Down buttons.

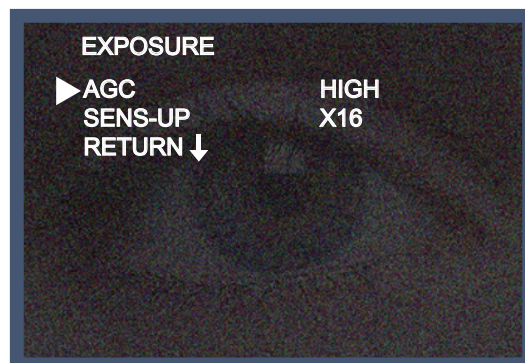
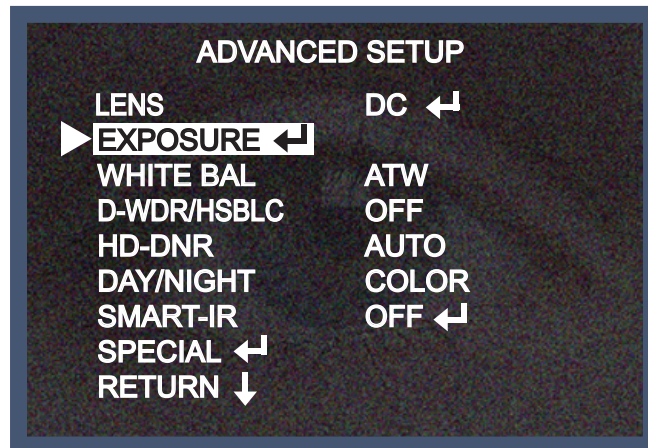

* AGC (AUTO GAIN CONTROL)

A higher gain increases brightness but also increases any noise on the image.

OFF: Deactivates the AGC function

LOW: Sets automatic gain control to LOW.

MIDDLE: Sets automatic gain control to MIDDLE.

HIGH: Sets automatic gain control to HIGH

* SENS - UP:

At night and/or in dark conditions, the Sens-Up mode can be selected to a desired value from x2 ~ x1024.

Changes depend on the Preset Mode basic default. Check the basic default on Page 11.

* RETURN:

Select Return to save the changes in the EXPOSURE menu and return to the SETUP menu.

NOTE

- * Pressing the SET button in AUTO mode allows adjustment of image brightness by increasing or decreasing the shutter speed (x2 ~x1024).
- * The higher the level, the brighter the image becomes, but it is possible that an after image (ghosting) could appear.
- * When SENS-UP is activated the increased magnification can induce noise and pixelation; this is quite normal.

White Balance

The White Balance function is used to control the “on-screen” colours.

1. Move the arrow indicator to WHITE BAL on the SETUP menu screen using the Up and Down buttons.
2. Select the desired mode using the Left or Right buttons.

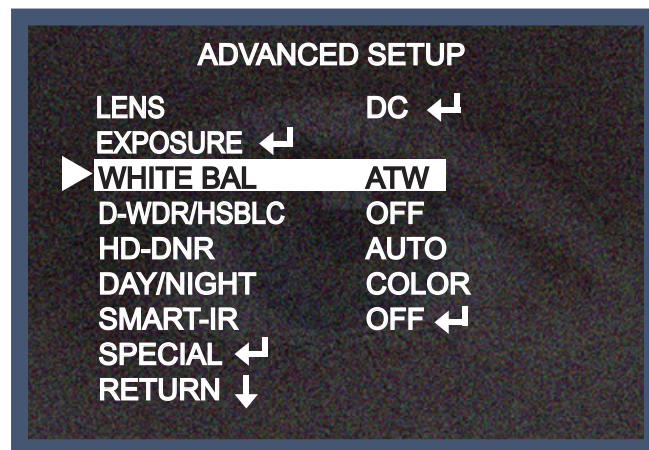

* There are three user selectable White Balance settings available.

* ATW: (Auto Tracking White Balance)

Normal setting; when the colour temperature range is from 1,800°K to 10,500°K (e.g. a fluorescent lamp or outdoors).

* AWC → SET: To obtain the best results press the SET button while the camera is focused onto white paper. If the environment, and/or light source changes, the White Balance will require re-adjustment.

* MANUAL: Used for fine adjustment of White Balance. Set White Balance first using ATW or AWC then change to MANUAL and press the SETUP button. Increase or decrease the value of M-WR (Red) and M-WB (Blue) while monitoring the colour of the image.

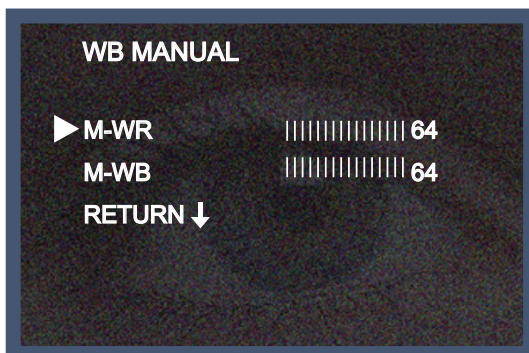

D-WDR/HSBLC

This camera which is using a 3D-DNR DSP that provides intelligent light level control to overcome strong backlight conditions.

1. Move the arrow indicator to WHITE BAL on the SETUP menu screen using the Up and Down buttons.
2. Select the desired mode using the Left or Right buttons.

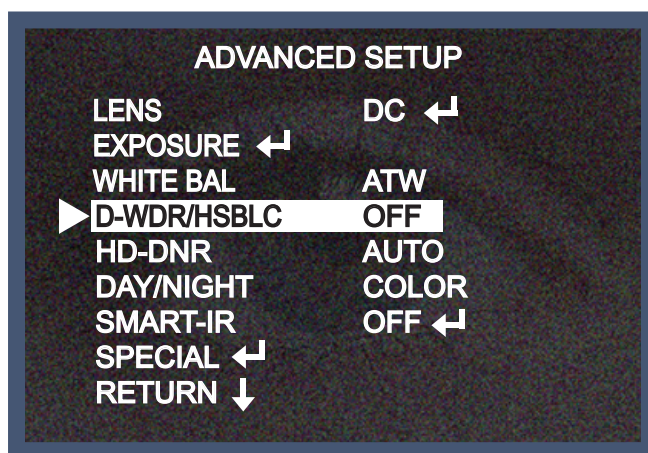

* OFF: BLC function does not operate.

* BLC LEVEL: Select LOW/MID/HIGH

BLC ZONE can be set to the desired area by changing the TOP/BOTTOM/LEFT/RIGHT values.

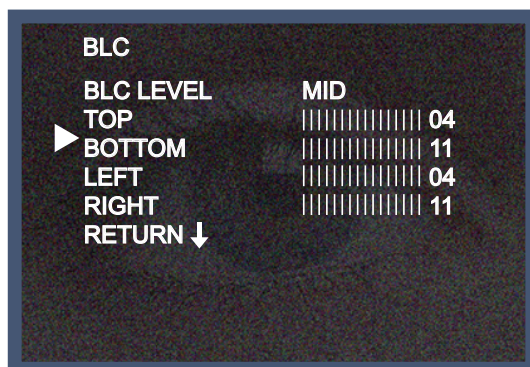

* RETURN: Select Return to save the changes in the D-WDR/HSBLC menu and return to the SETUP menu.

* HSBLC: HSBLC function is especially effective for reading car number plates at night time.

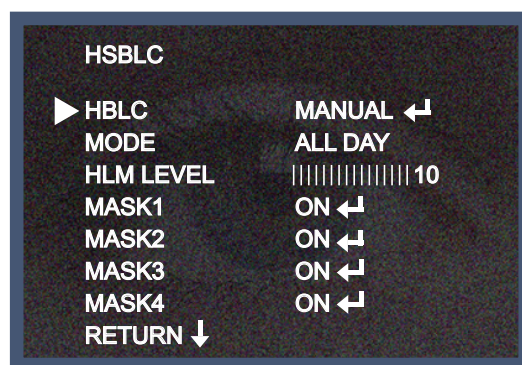

* HSBLC: Can be used in conjunction with BLC.

The area for HSBLC can be set by changing the TOP / BOTTOM / LEFT / RIGHT values.

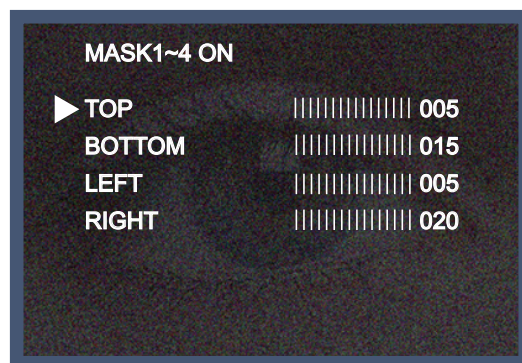

It is possible to set by changing the TOP/BOTTOM/LEFT/RIGHT in the MASK 1 to 4 zones.

* RETURN: Select Return to save the changes in the D-WDR/HSBLC menu and return to the SETUP menu.



HSBLC OFF



HSBLC ON

* D-WDR: This camera which is using a 3D-DNR DSP that provides intelligent light level control to overcome strong backlight conditions.

→OFF: D-WDR function does not operate.

When images contain both bright and dark areas, this feature makes good quality pictures by making bright areas a little bit darker and dark areas a little brighter. The WDR level is adjustable.

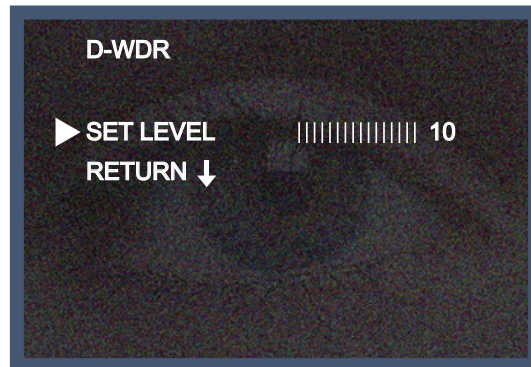

D-WDR OFF



D-WDR ON

* RETURN: Select Return to save the changes in the D-WDR/HSBLC menu and return to the SETUP menu.

3D-DNR

3D-DNR is used to reduce the level of background noise in a low luminance environment.

1. Move the arrow indicator to 3D-DNR using the Up and Down buttons.

When movements in the picture are detected, 3D-DNR AUTO can reduce the level of noise; with a low-level DNR setting. If there are no moving picture elements, noise can be reduced using a high-level DNR setting.

OFF, LOW, MID. and HIGH can be selected using Left and Right buttons.

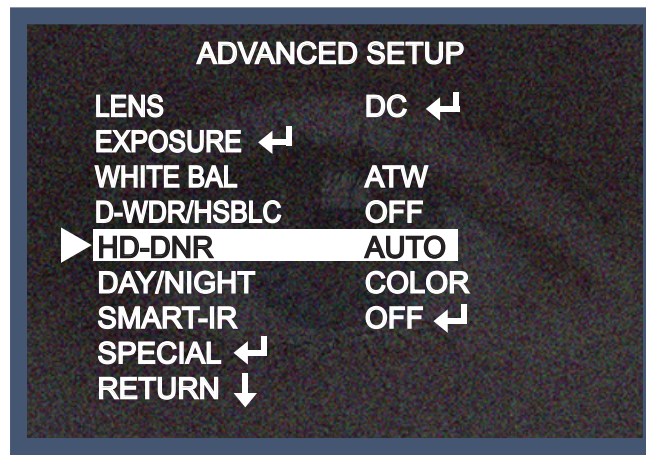

* Select RETURN to return to the Set Up menu screen.

Day / Night

Pictures can be displayed in either colour or black and white.

1. Select DAY / NIGHT using the Up or Down buttons on the SETUP menu screen.

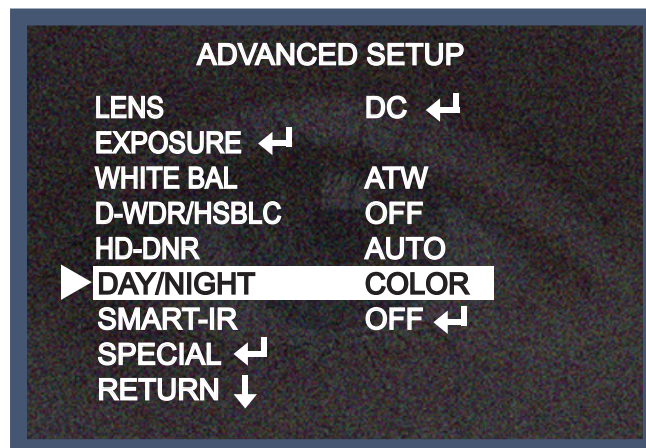

2. Select the desired mode using the Left and Right buttons.

* COLOUR: The picture is always displayed in colour.

* BW: The picture is always displayed in black and white.

Select BW using the button and press the menu to activate COLOR BURST option.

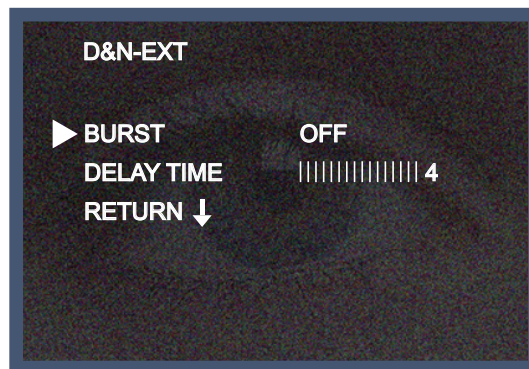

→ AUTO: The mode will automatically switch to COLOR in normal condition and switch to BW mode when ambient illumination is low.

Press the SET button to set the switching time or Day→Night (AGC), Night→Day (AGC) in AUTO mode.

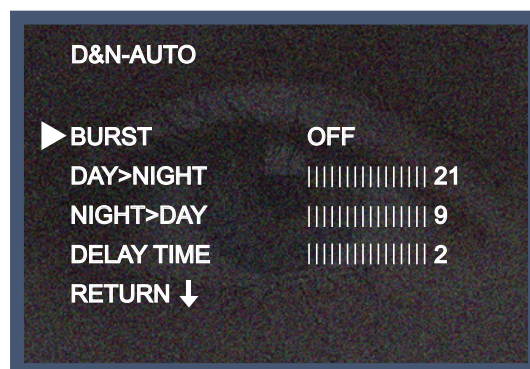

SMART-IR (IR Models Only)

SMART-IR: Controls the IR LED (bright portion), saturation is not expected.

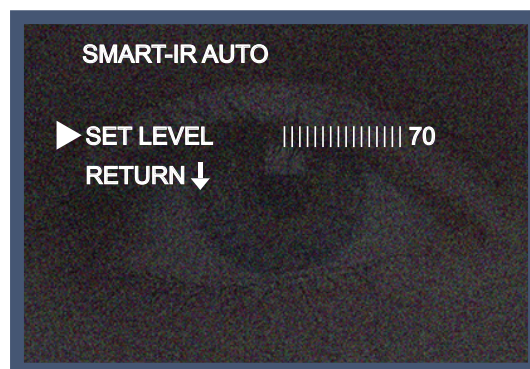
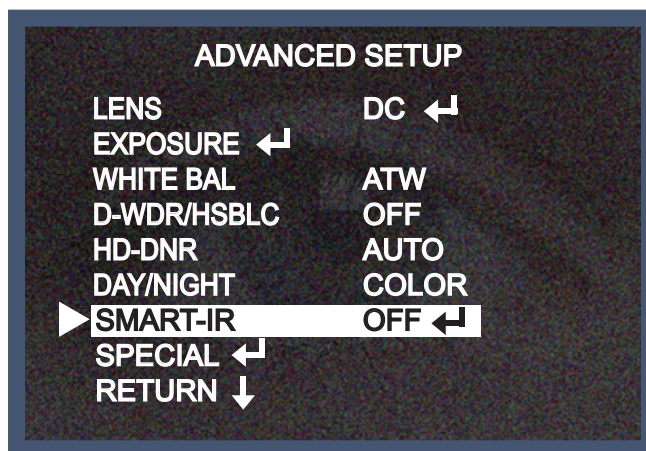

LED Saturation level can be adjusted by changing the SET LEVEL.

* NOTE: When setting SMART-IR ON, the function D-WDR, HSBLC, and BLC cannot be used in BW mode.

It can only function in colour.



SMART IR OFF



SMART IR ON

Special

When the SETUP menu screen is displayed, select SPECIAL using the enter buttons.

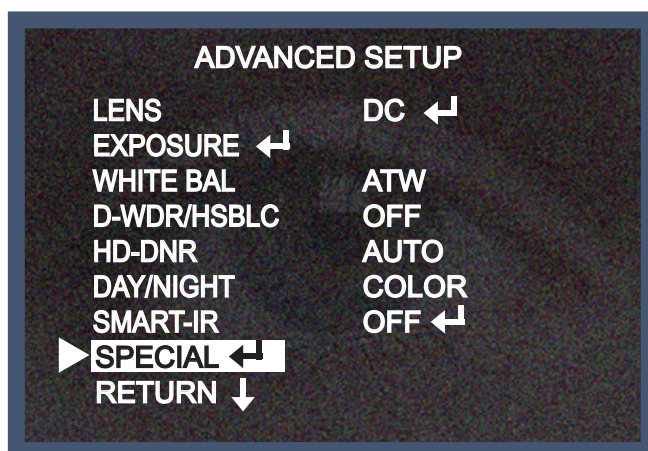

Select one of the modes using the Up and Down buttons.

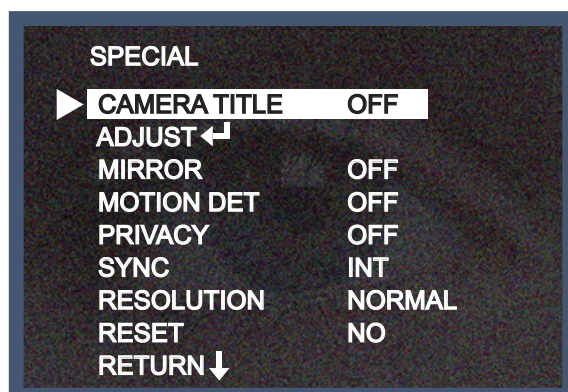

1. CAMERA TITLE: When input, the Camera ID is displayed on the monitor.

1-1) Move the arrow indicator to CAMERA ID using the Up or Down buttons on the SETUP menu screen.

1-2) Set to ON using the Left or Right buttons.

NOTE

* When CAMERA TITLE is set to OFF, the CAMERA TITLE is not displayed on the monitor.

1-3) Press the SETUP button.



1-4) The CAMERA TITLE can be up to 15 alphanumeric characters in length.

Move the cursor to choose an alphanumeric character.



Choose a character in displayed range A~Z, 0~9 using the Up, Down, Left and Right buttons.

Select the desired character by pressing the SETUP button.

The cursor moves to the next position, after character input, by pressing the SETUP button.

Repeat the above steps until the Camera ID has been created.

NOTE

* If the wrong Camera ID has been input.

Move the cursor to CLR and press the SETUP button to erase characters from left to right, and repeat the above steps to input the characters again.

1-5) To select the position where the Camera ID should be displayed on the screen.

Move the cursor to POS and press the SET button.



Created camera ID is displayed.

(factory default position)



Select a new position by using the four directional button, Press the SET button to confirm the position.



2. ADJUST: When the SETUP menu screen is displayed, select ADJUST using the Up and Down buttons.

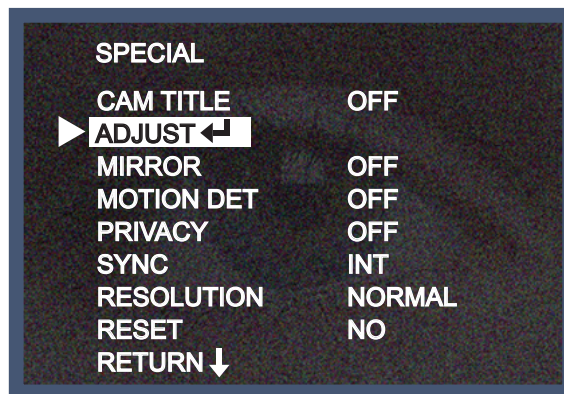

2-1) SHARPNESS: Select the desired mode using Up or Down buttons.

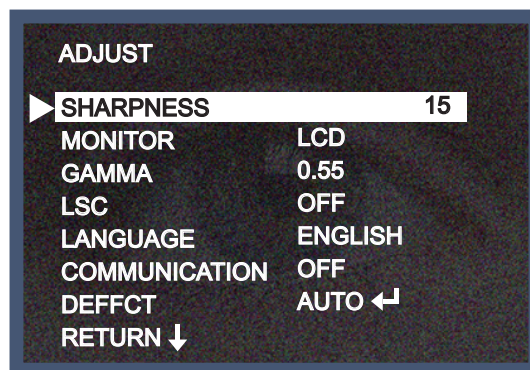

Improving image clarity. The level can be adjusted to obtain an improved image. However, when the level is set too high it can distort the image or cause noise. You can adjust from level 0 to 30, and can set the monitor function as LCD or CRT.

2-2) MONITOR: Select the desired mode using Up or Down buttons.

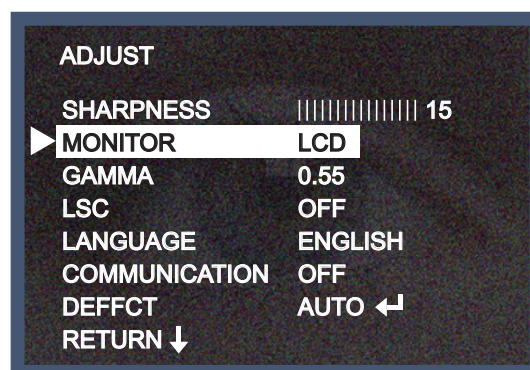

Change the setting value appropriate to your monitor

LCD: Select when using a LCD monitor

CRT: Select when using a CRT monitor

2-3) GAMMA: Desired gamma values can be adjusted between user 0.20 ~ 1.00.

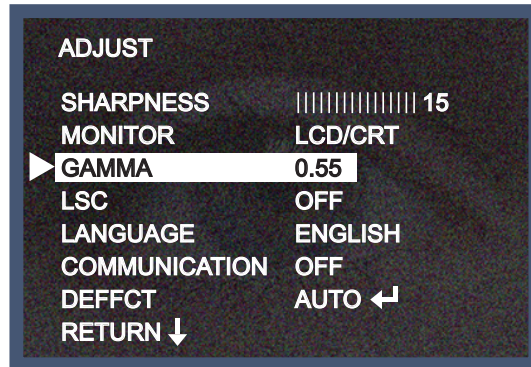

LSC: This function compensates for the difference in light quantity between the centre of lens and the periphery. It can be adjusted from 0 to 30.

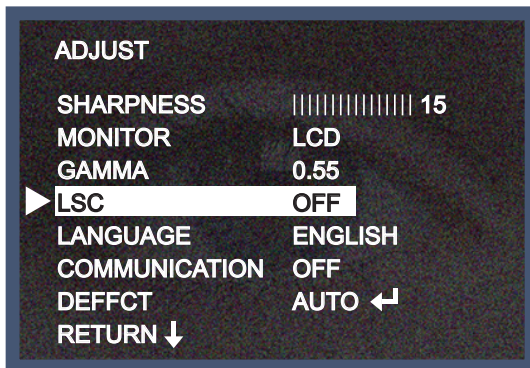

2-5) Language: Press the button of left and right for selecting language.

English, Russian, Spanish, Italian, French, Turkish, Chinese, Korean and Japanese can be selected.

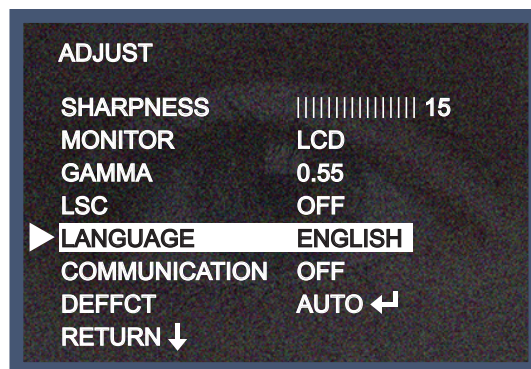

2-6) COMMUNICATION :

ID: Camera ID can be adjusted from 1 to 254.

BAUD RATE can be adjusted from 2400bps to 57600bps.

PROTOCOL - can only support PELCO-D protocol.

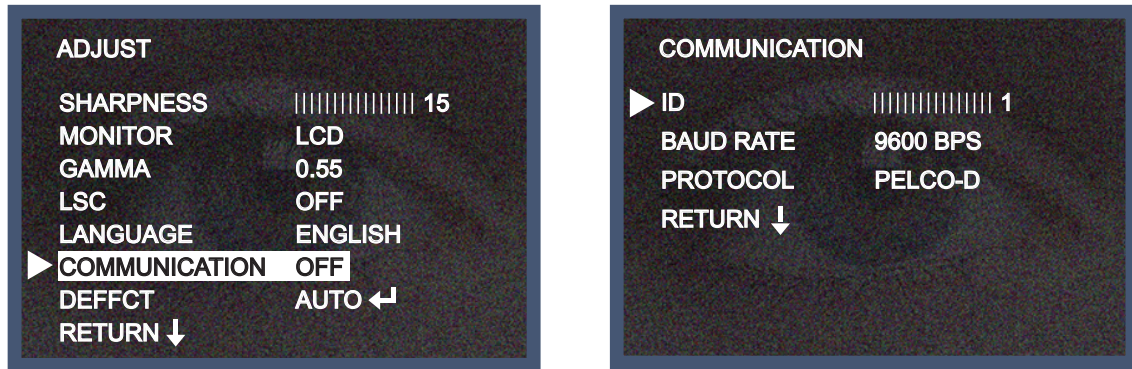

2-7) AUTO DEFECT

When set to AUTO this function corrects black and white dots caused by pixel failure, in real time, when Sens Up is on. When changing from OFF to AUTO, you will see the reduction in pixels which are permanently on (white dot) and those permanently off (black dot).

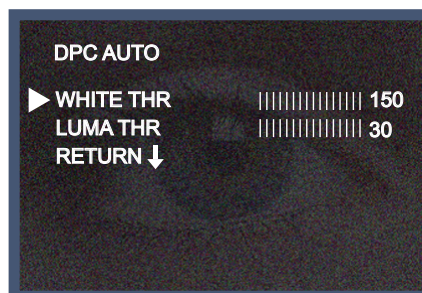
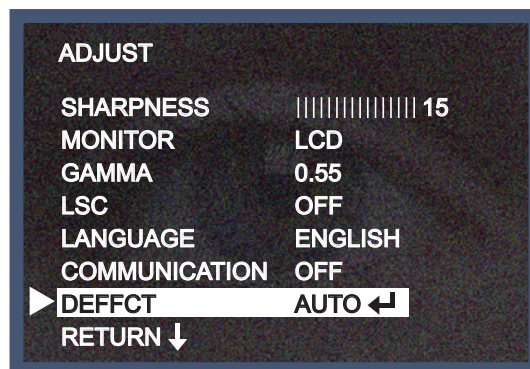

2-8) RETURN: Move the arrow indicator to RETURN after completing the setup to return to the SPECIAL menu.

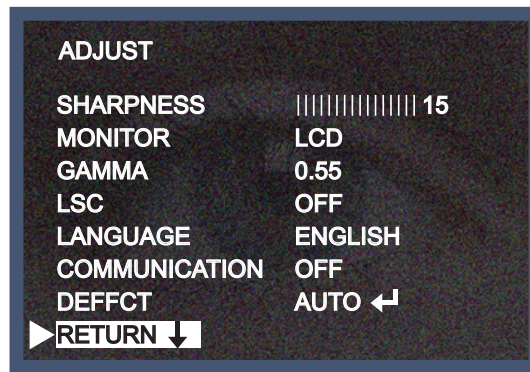

3. MIRROR: Flip the image horizontally on the screen.

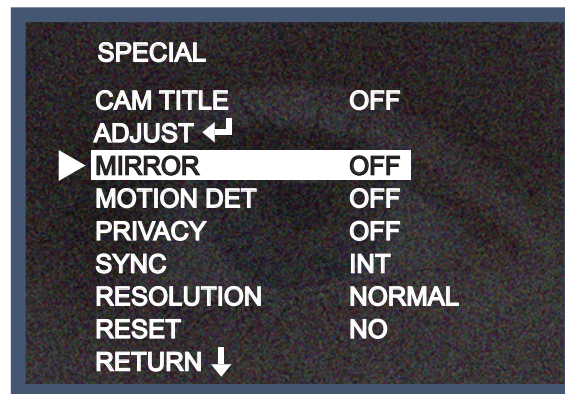

MIRROR ON



MIRROR OFF

4. MOTION DET: When the special menu screen is displayed, use the Up and Down buttons to access the MOTION menu.

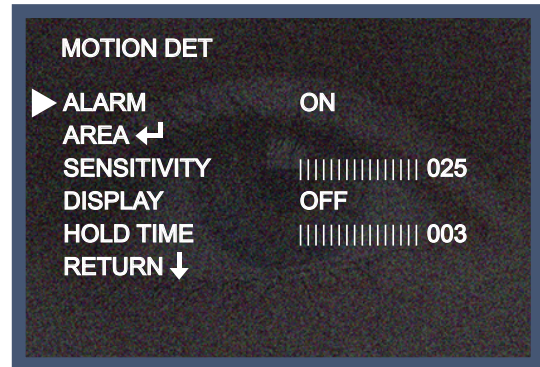
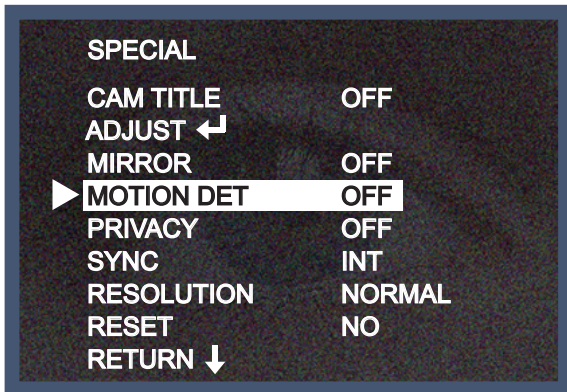

AREA SELECT: You can select from area 1~4.

AREA ON: The desired area can be altered using TOP, BOTTOM, LEFT and RIGHT.

SENSITIVITY: To set the motion sensitivity. You can adjust the motion sensitivity of movements between level 1~30.

DISPLAY: ICON, TRACE and TEXT can be selected. When setting TEXT, the text string "MOTION DETECTION" is on the monitor.

HOLD TIME: When setting the time for ALARM OUT HIGH, 003 means "three seconds."

RETURN: To return to the SPECIAL menu after completing the setup.

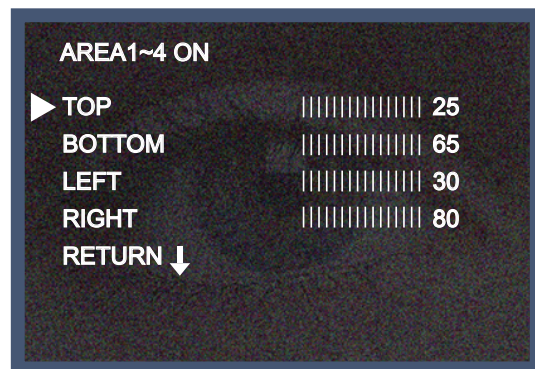
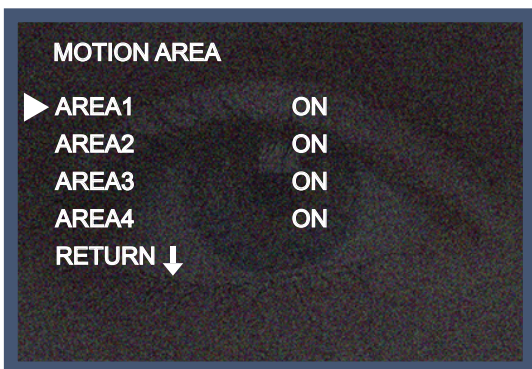

5. PRIVACY

Hide an area you want to prevent from being displayed on the screen.

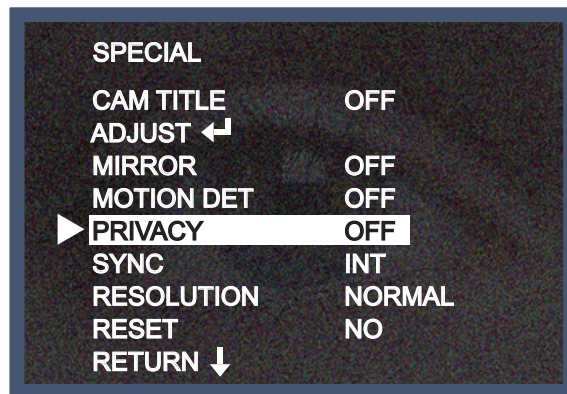

5-1) When the SPECIAL menu screen is displayed, press the Up and Down buttons to set PRIVACY.

DOT-SEL: The function for selecting each vertex.

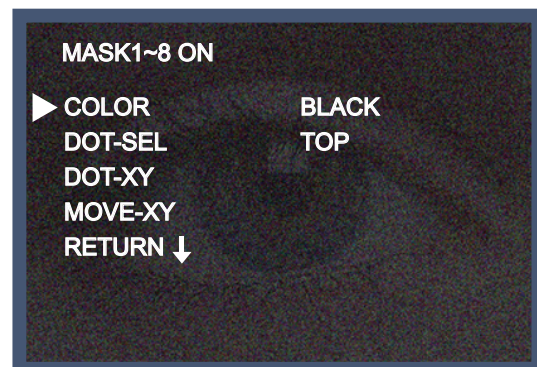
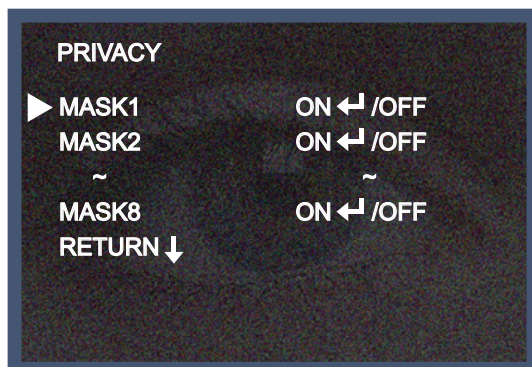

5-2). Set up the area mode using the 4 directional buttons.

MASK 1 - 8: You can select up to 8 MD areas.

MASK OFF: Disabled

ON: Activates area display

Move the arrow indicator to DOT XY to increase or decrease the width of cells using the Left / Right buttons - between the adjustable levels.

Move the arrow indicator to DOT XY to increase or decrease the height of cells using the Left / Right buttons - between the adjustable levels.

Move the arrow indicator to MOVE XY to select the desired area position using the LEFT or RIGHT buttons.

Move the arrow indicator to COLOUR to select the desired colour of each area's cells using the Left / Right buttons to select from 8 different colours.

RETURN: Move the arrow indicator to RETURN after completing the setup to return to the SPECIAL menu.

6. SYNC: INT (Internal Synchronisation)

Move the arrow indicator to RETURN after completing the setup to return to the SPECIAL menu.

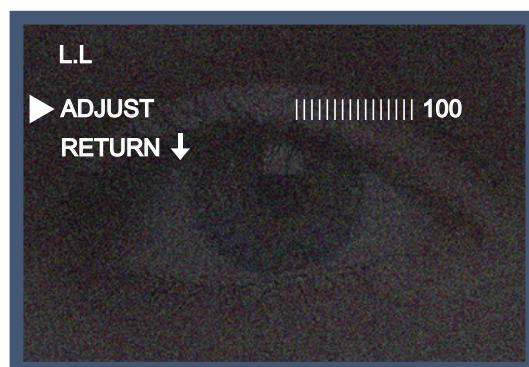
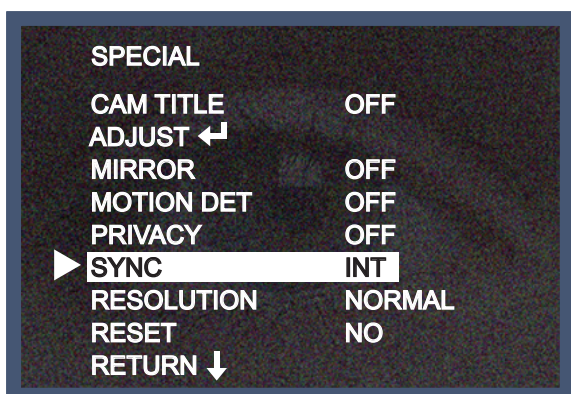

7. RESOLUTION: This function changes the image with reference to the resolution.

When set to HIGH, TV Lines are increase but image artefact elements can also increase and general image quality may be affected.

Recommended setting is NORMAL

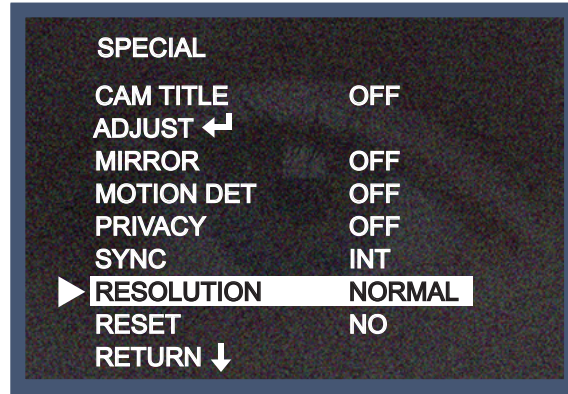

8. RESET: Reset the camera setting to the factory defaults.

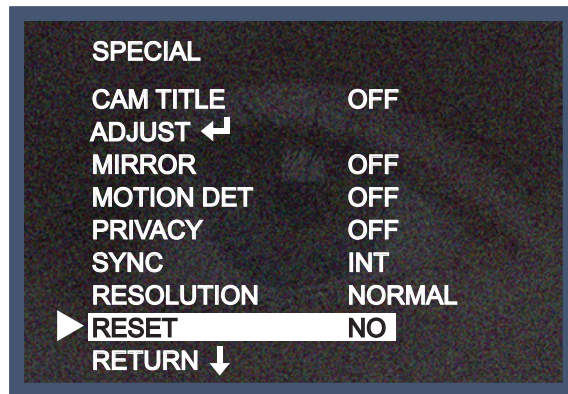

9. Return: Select this to save the SPECIAL menu setting and return to the ADVANCED SETUP menu.

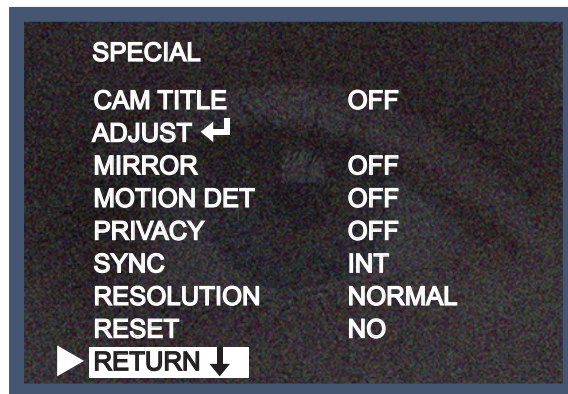

RETURN

Press the SET button in the RETURN menu to save the current settings and exit the SETUP menu.

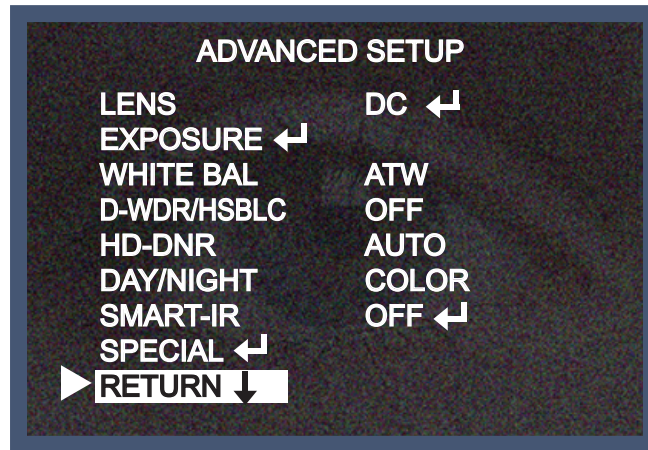

Specification

MODEL	VRD73IR
Sensor	1/3" Sony Super HAD CCD II
TV System	PAL / NTSC
Total Pixels	PAL=795(H) * 596(V) / NTSC=811(H) * 508(V)
Effective Pixels	PAL=752(H) * 582(V) / NTSC=768(H) * 494(V)
Lens	2.8~12mm Varifocal Auto Iris
Scanning System	2:1 Interlace
Synchronisation	Internal / LINE LOCK
Resolution	620 TVL
Minimum Illumination	IR LED ON: 0.00001 LUX
S/N Ratio	52dB (AGC OFF Weight ON)
Colour**	AUTO (With IR Cut-Filter)
OSD	YES
DNR	OFF / LOW / MID / HIGH / AUTO (MOTION)
BLC / HSBLC	OFF / ON
Day & Night	COLOUR / BW / AUTO / EXT
Gain Control	OFF / LOW / MID / HIGH
White Balance	ATW (1,800K ~ 10,500K) / AWC / MANUAL
Sens-Up	AUTO (x2~x1024)
Motion Detection	ON / OFF (4 Programmable Zones)
Privacy Masking	ON / OFF (8 Programmable Zones)
D-WDR	OFF / ON (Level Adjustable)
SMART- IR*	1~100 (Level Adjustable)
Sharpness	ON / OFF (Level Adjustable)
Filp / Mirror	Horizontal
Pixel Compensation	AUTO
Power Supply	Dual Voltage (DC12V / AC24V)
Power Consumption	IR LED ON: 500mA Max
IR LEDs & Illumination Range	28pc up to 25m [^]
UTP**	UTP transmitter is included in the camera therefore an additional UTP transmitter is not required
IP Rating	IP67
Operational Temperature	-20 ~ +50°C. RH 95% Max.
Storage Temperature	-20 ~ +60°C. RH 95% Max.
Dimensions	135mm (W) * 100mm (H) * 135mm (D)
Weight	900g

[^]Important Note - The illumination range assumes ideal conditions

*IR Models Only

**True Day Night Models Only

Troubleshooting

PROBLEM	POSSIBLE CAUSE
Nothing appears on the screen.	Check the power cable, power supply output and video connection between camera and monitor.
The image on the screen is dim.	<p>Is the camera lens or the lens glass dirty? Clean the lens / glass with a soft clean cloth.</p> <p>Adjust the monitor controls, as required.</p> <p>If the camera is facing a very strong light, change the camera position.</p> <p>Adjust the lens focus.</p>
The image on the screen is dark.	<p>Adjust the contrast control of the monitor.</p> <p>If there is an intermediate device, correctly set the 75Ω/Hi-z.</p>
The camera is not working properly and the surface of the camera is hot.	Check the camera is correctly connected to an appropriate regulated power source.
Motion Detection is not activated.	<p>Has MOTION DET been set to ON in the menu?</p> <p>Has MD AREA been properly defined?</p>
The colour of the picture is not correct.	Check the settings in WHITE BALANCE menu.
The image on the screen flickers.	Make sure that the camera isn't facing direct sunlight or fluorescent lighting. If necessary, change the camera position.
The SENS-UP does not work.	<p>Check that the AGC setting in the EXPOSURE menu isn't set to OFF.</p> <p>Check the EXPOSURE menu and make sure SHUTTER is set to -----.</p>

- MEMO -



GENIE CCTV LTD.

CCTV House, City Park, Watchmead, Welwyn Garden City, Hertfordshire, AL7 1LT

Tel: +44 (0) 1707 330541 Fax: +44 (0) 1707 330543

www.geniecctv.com

Edition. GN-MARCH 2013