





➔ **A**s a result of customer feed back and market trends VINDEX has introduced a new range of audio and video door entry kits. The new **SMART Series** video kits have been added while the current video kits have all been updated to include the **3000 Series Videophone**.

The new *Slim Kit* has been added to the audio kit range while the current audio kits have all been updated to include the **3000 Series Smart line Intercoms** and new outdoor stations. The **SMART series** video kit uses the 3000 Series videophones and a new outdoor station which has many new features: it is small and compact with a new door panel design, it is only available in surface mount, the new panel allows for camera adjustment horizontally and vertically (10 degrees) and has a 2nd outdoor station facility (two entrance video system)

➔ With the introduction of **3000 Series Videophones** to all VINDEX video kits, it is now possible to enable up to 3 auxiliary services in addition to the "door open" and "camera recall", plus it also allows for the adjustment of the electronic call tone volume with 3 different levels.

VINDEX video kits have been designed for ease of installation, and are based on a 6-wire system removing the need of a coax cable for the video signal. Video kits allow for the connection of additional intercoms, videophones or extension sounders.

Vindex video kits are available in B&W and Colour (add "C" before the video kit code), one button and two button version (except videokit with brass outdoor station which are available only in one button version) and with surface or flush mount outdoor station (except SMART Series video kits which are surface mount only). The B&W video kits are also available in a version with a videophone which includes a built in memory board and is provided with the relevant power supply Art.850K/IMV (Type A 8 module DIN box).

Videophones with memory board allow for the storage of up to 32 video pictures with the date & time of the call, the videophone can be operated automatically or manually. To order video kits with this videophone model, simply add the "/MV" to the video kit code. Each videophone provided with the video kits can be ordered as an extension monitor with the relevant power supply (Maximum of three videophones per system).

Standard kit versions (except Smart Videokit, Slim kit, Two wire kit and Smart Kit) have outdoor station front plate in stainless steel while the flush mounting box, surface mounting box and rainshields are all finished.

# Videokit Smart Series

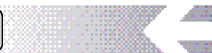

## SMVK1

One button videokit comprised of:

- 1 **Art.331K** One call button outdoor station (surface mount only) complete with high quality auto iris lens CCD B&W camera and infrared illumination LEDs. Horizontal & Vertical camera adjustment (10 degrees).
- 1 **Art.3351** 3000 Series Videophone with 4" B&W flat screen monitor, "door open" and "camera recall" push buttons, 3 "service" push buttons and electronic call tone with adjustable volume on 3 levels. Complete with wall mount support Art.3980.
- 1 **Art.850K** Power transformer in a Type A 5 module DIN box.  
Packing: box 57x26,5x7cm total weight 3,2Kg.

## CSMKV1

As **SMVK1** but with 4" colour TFT flat monitor Art.3451 and colour outdoor station Art.331KColour. Packing: as above

## SMVK2, CSMVK2

As video kits above but two button version with 2 videophones, 2 power supplies and 2 button outdoor station (Art.331K-2).  
Packing: cardboard 28x26x24cm total weight 5Kg

The outdoor station front plate is available in 2 finishes: White / **W** and Grey / **G**. For colours see pic.1 on page 15.

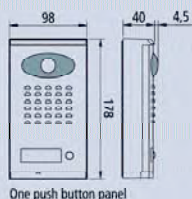

One push button panel

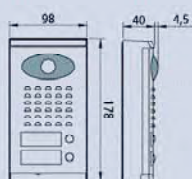

Two push button panel

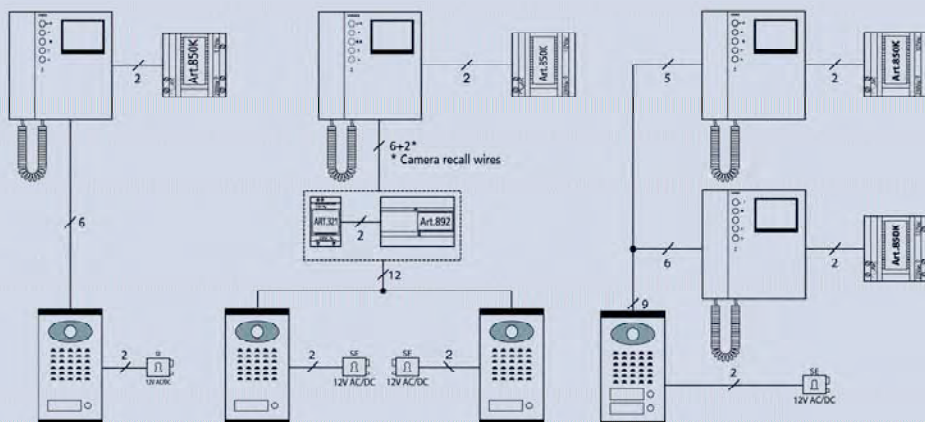



# VK6N Videokit Series



4



## VK6N

One button videokit comprised of:

**1 Outdoor station including camera unit (Art.831K) with high quality auto iris lens CCD B&W camera and infrared illumination LEDs, flush mounting box with module support and stainless steel hinge (Art.855) plus a rainshield (Art.875). Standard front plate finish in stainless steel.**

**1 Art.3351 3000 Series Videophone with 4" B&W flat screen monitor, "door open" and "camera recall" push buttons, 3 "service" push buttons and electronic call tone with adjustable volume on 3 levels. Complete with wall mount support Art.3980.**

**1 Art.850K Power transformer in a Type A 5 module DIN box.**

Packing: box 57x26,5x7cm total weight 3,9 Kg.

**CVK6N** - As VK6N but with 4" colour TFT flat monitor Art.3451 and colour camera unit (Art.831KColour).

**VK6NBR, CVK6NBR** - As VK6N and CVK6N but with flush mount Brass outdoor station. For brass kits an optional rainshield Art.875/BR and an optional surface mount box Art.885/BR. The videokit with brass outdoor station are only available in a one button version. Packing: briefcase 45x41x10cm total weight 5 Kg.

**VK6N-2, CVK6N-2** - As VK6N but with two button version camera unit (Art.831K-2), 2 videophones and 2 power supplies.

Packing: Cardboard 28x26x23cm total weight 7 Kg.

**VK6N-S, CVK6N-S**

As the flush mount versions but with surface mounting box (Art.885).

Packing: box 57x26,5x7cm total weight 4,5 Kg.

**VK6NBR-S, CVK6NBR-S**

As the relevant flush mount versions but with surface mounting box Art.885/BR

Packing: Briefcase 45x41x10cm total weight 6Kg for one button version.

**VK6N-2S, CVK6N-2S**

As the flush versions, but with surface mounting box (Art.885).

Packing: Cardboard 28x26x23cm total weight 7,5 Kg.

The outdoor station front plate (except for brass outdoor station) is available in different finishes, for colours and codes see pict. 2 on page 15.

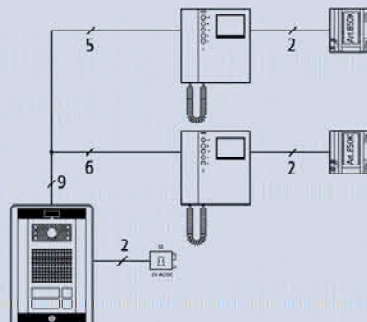
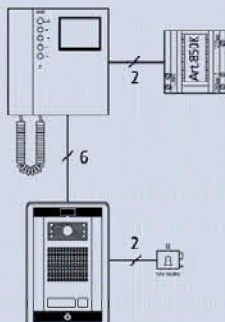
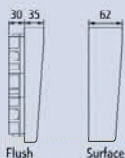
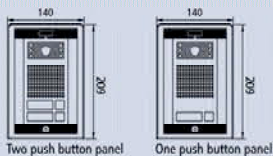

# Colour TV Videokit

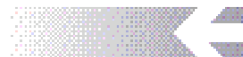

Videx have now developed a new Videokit which will link to a television through a spare Scart socket. This will enable the caller to be displayed on the TV during a call (The channel will automatically switch to the camera when a call is activated and switch back to the previous channel after the call).

**SMVK/TV** - One button videokit comprised of:

**1 Art.331K Colour** One call button outdoor station (surface mount only) complete with high quality auto iris lens CCD colour camera and infrared illumination LEDs. Horizontal & Vertical camera adjustment (10 degrees).

**1 TV Euro-Connector** with 3mt. cable + connecting wall plastic box (Art. SCART VK/TV).

**1 900 Series Intercom** specific for this kit with "door open" and "camera recall" push buttons (Art. VS901K/TV).

**1 Art.850K** Power transformer in a Type A 5 module DIN box.

Packing: Briefcase 40x32x9cm total weight 3Kg.

The outdoor station front plate is available in 2 finishes: White /W and Grey /G. For colours see pict.1 on page 15.

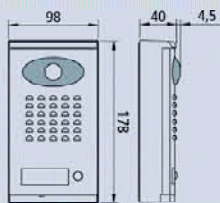

One push button panel

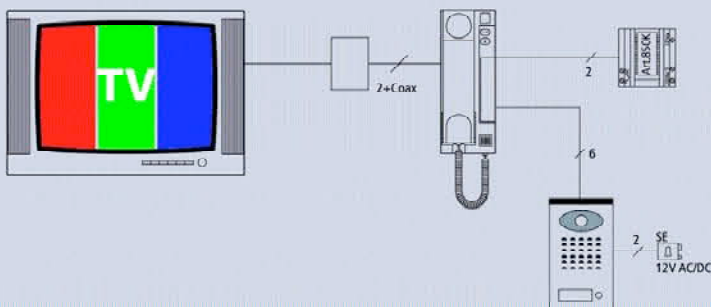



## VKC6N

One button videokit as VKC6N with the addition of a digital code lock, it comprises of:

1 Outdoor station including camera unit (Art.831Kcode) with high quality auto iris lens CCD B&W camera and infrared illumination LEDs, a digital codelock (Art.VX800-2L Codelock module, 2 codes / 2 relays outputs with illumination panel), flush mounting box with module support and stainless steel hinge (Art.857) plus a rainshield (Art.877). Standard front plate finish in stainless steel.

1 Art.3351 3000 Series Videophone with 4" B&W flat screen monitor, "door open" and "camera recall" push buttons, 3 "service" push buttons and electronic call tone with adjustable volume on 3 levels.

Complete with wall mount support Art.3980.

1 Art.850K Power transformer in a Type A 5 module DIN box.

Packing: briefcase 45x41x10cm Total weight 4,5 Kg.

## CVKC6N

As VKC6N but with 4" colour TFT flat monitor Art.3451 and colour camera unit (Art.831KCodeColour).

## VKC6N-2, CVKC6N-2

As videokits above but with two button version camera unit (Art.831KCode-2), 2 videophones and 2 power supplies.

Packing: cardboard 35x26x23cm total weight 8 Kg for two button version.

## VKC6N-S, CVKC6N-S/VKC6N-2S, CVKC6N-2S

As flush versions but with surface mounting box (Art.887).

Packing: the same as relevant flush model with total weight 5 Kg for one button version and 8,5 Kg for two button version.

The outdoor station front plate is available in different finishes: standard stainless steel, aluminium /A and bronze /BZ. For colours see pict. 2 on page 15.

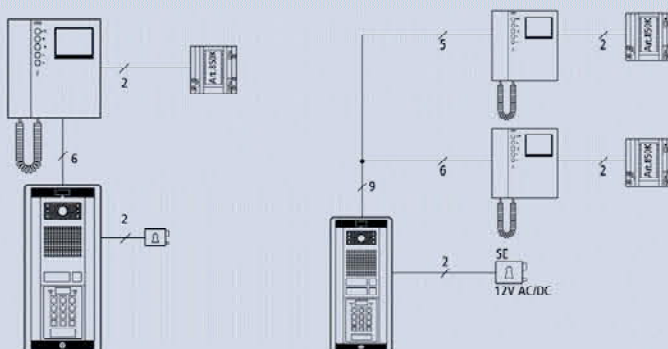
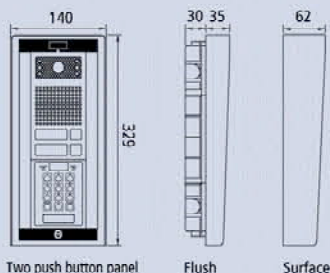



# Videprox Kit

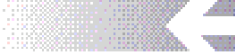

## VKX6N

As the VK6N with the addition of a proximity door open system, the one button version comprises of:

- 1 Outdoor station including camera unit (Art.831K) with high quality auto iris lens CCD B&W camera and infrared illumination LEDs, a proximity key reader module (Art.849), flush mounting box with module support and stainless steel hinge (Art.857) plus a rainshield (Art.877). Standard front plate finish in stainless steel.
  - 1 Art.VproX20 VproX system CPU which will store up to 20 proximity cards Art.955/C or Tags Art.955/T.
  - 3 Art.955/C Proximity card (Tag Art.955/T available on request)
  - 1 Art.3351 3000 Series Videophone with 4" B&W flat screen monitor, "door open" and "camera recall" push buttons, 3 "service" push buttons and electronic call tone with adjustable volume on 3 levels.  
Complete with wall mount support Art.3980.
  - 1 Art.850K Power transformer in a Type A 5 module DIN box.
- Packing: Briefcase 45x41x10cm Total weight 4,5 Kg.

## CVKX6N

As VKX6N but with 4" colour TFT flat monitor Art.3451 and colour camera unit (Art.831KColour).

### VKX6N-2, CVKX6N-2

As videokits above but with two button version camera unit (Art.831K-2), 2 videophones and 2 power supplies.

Cardboard 35x26x23 cm total weight 8 Kg for two button version.

### VKX6N-S, CVKX6N-S/VKX6N-2S, CVKX6N-2S

As flush versions but with surface mounting box (Art.887).

Packing: the same as relevant flush model with total weight 5Kg for one button version and 8,5 Kg for two button version.

The outdoor station front plate is available in different finishes: standard stainless steel, aluminium /A and bronze /BZ. For colours see pict. 2 on page 15.

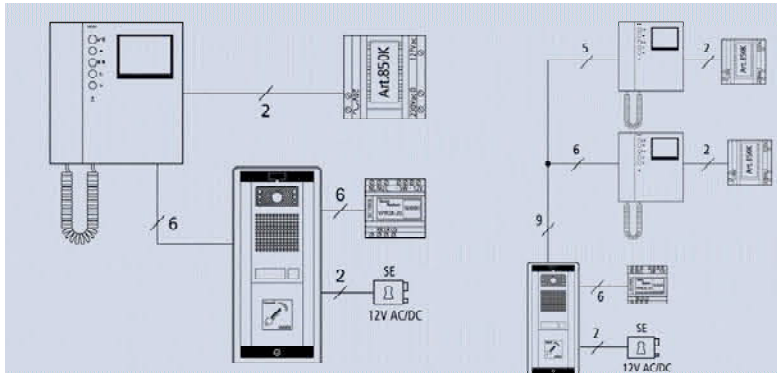
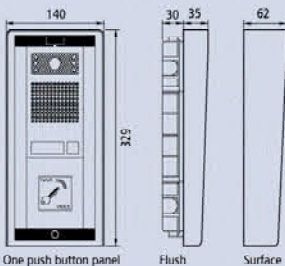

# Slim Kit

8



The SLIM KIT uses a completely new surface mounting outdoor station. The front panel, is of a slim design. The panel is manufactured from one piece of die-cast aluminium alloy which gives substantial strength to the outdoor station. The outdoor station circuitry has a built-in lock relay, this reduces the cable requirements to only 4 wires ("3+1") between the outdoor station and the intercom. The reduced cable requirement allows longer cable runs and reduced cable sizes to be used between the two units. The outdoor station is provided with a 3mt length cable.

## SLK

One button door entry kit comprised of:

1 Art.436 Surface mount slim line outdoor station with built in lock relay.

1 Art.3011 3000 Series Smart Line wall mountable telephone with "door open" push button and electronic call tone with adjustable volume on 3 levels.

1 Art.321 Power Supply in a type A 3 module DIN box. 1

Packing: box 24,5 x 25,5 x 6,5 cm total weight 1,5 Kg

## SLK/DDA

To meet DDA requirements the SLIM KIT is available with a DISABLED LOGO and PRESS FOR HELP legend. Retaining all the features of the standard SLIM KIT, including the high contrast call button. The kit is ideal for HELP POINT applications and where access or assistance may be required.

Optional DC. operation with battery back up is also available.

## SLK/DDA

As SLK

Optional DC Power Supply with battery back up

1 Art 521B DC Power Supply with battery back-up facility in type A 9 DIN box.

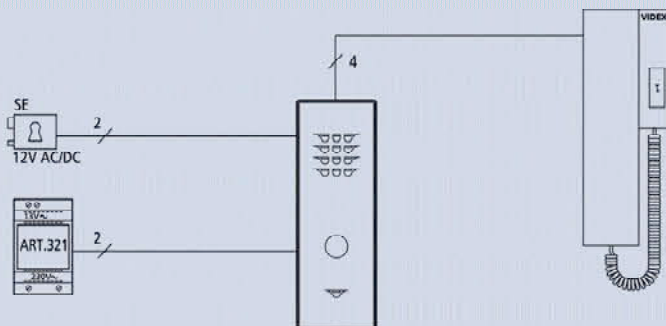
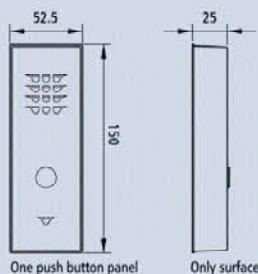



# 3K Audiokit - EK380



## 3K AUDIOKIT

The circuitry of the outdoor stations provided with these kits, has a built-in lock relay to enable the electric lock. This reduces the cable requirements to only 4 ("3+1") between the outdoor station and the intercom. This reduced cable requirement allows longer cable runs and reduced cable sizes to be used between the two units.

**3K1** - One button door entry kit comprised of:

1 One outdoor station including a one call button speaker unit (Art.836M-1), flush mounting box with module support and hinge (Art.851) plus covering frame (Art.861). Standard front plate finish in stainless steel.

1 Art.3011 3000 Series Smart Line wall mountable telephone with "door open" push button and electronic call tone with adjustable volume on 3 levels.

1 Art.321 Power Supply in a type A 3 module DIN box.

Packing: box 30,5x29x7cm total weight 1,4 Kg.

**3K2** - As 3K1 but two button version with 2 intercoms and 2 call push button speaker unit (Art.836M-2). Packing: box 41x39x7cm total weight 1,75 Kg.

**3K1-S, 3K2-S** - As above door entry kits but with surface mounting box (Art.881).

Packing: the same as the flush version but with a total weight of 1,85 Kg for one button version and 2,2 Kg for two button version.

## EK380

One button door entry kit (no telephone handset) but with the addition of an SP380 telephone interface module.

This allows the standard house telephone (corded or cordless) to operate as normal with the added facility to answer a call from the door panel, speak to the visitor and enable the electric lock or gate opening mechanism.

The EK380 will also allow for the redirection of a call made at the door panel to either a land line or mobile telephone.

The EK380 can also be connected to an analogue line port of a telephone switch.

## EK380

1 Outdoor station including a one call button speaker unit (Art. 837-1), flush mounting box with module support and hinge (Art851) plus covering frame (Art861). Standard front plate finish in stainless steel.

1 Art.520M Power Supply in a type A 8 module DIN box.

1 SP380 Telephone Interface in a type A 9 module DIN box

1 TJ2/4A Master telephone socket

## EK380S

As EK380 but with surface mounting box (Art881)

The outdoor station front plate is available in different finishes, for colours and codes see pict. 3 on page 15.

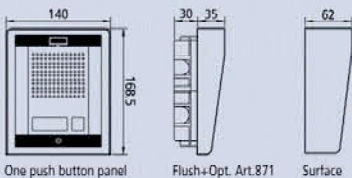

## 3K AUDIOKIT

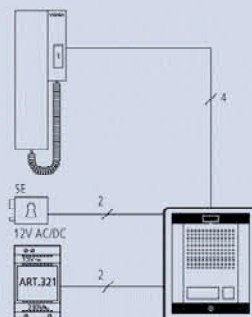

## EK380(S)

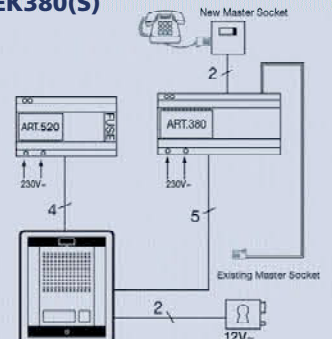

# “Two Wire” Kit

10



This is a complete door entry system using only two wires between the outdoor station and the indoor unit plus the facility for a second handset to be wired in parallel and an extension sounder. The intercom provided has a service push button.

## ESK-1

One button door entry kit comprised of:

1 Art.332 One call button flush mount outdoor station.

1 Art.3151 3000 Series wall mountable telephone with “door open” push button, “service” push button and electronic call tone with adjustable volume on 3 levels.

1 Art.321 Power Supply in a type A 3 module DIN box.

Packing: box 30,5x29x7cm total weight 1,3 Kg.

## ESK-15

As door entry kit above but with surface mounting outdoor station (Art.332S).

Packing: box 30,5x29x7cm total weight 1,5 Kg.

For flush mounting outdoor station an optional rainshield Art.371 and surface mounting box Art.381 are available.

The outdoor station front plate and the optional rain shield are available in 3 different finishes: add /A to the product code for aluminium finish, /G for gold and /W for white. For colours see pict. 4 on page 15.

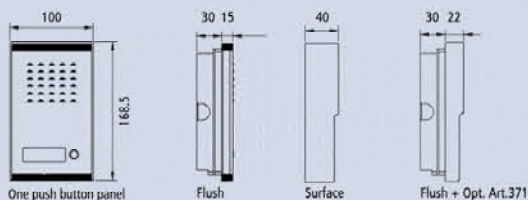

One push button panel

Flush

Surface

Flush + Opt. Art.371

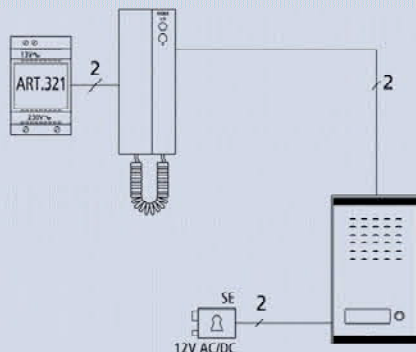

12V AC/DC

# Vandal Resistant Kit



## VRDK 1 to VRDK 20

One button to twenty button Vandal Resistant Audio Kit comprising:  
 Flush 12 SWG stainless steel 1 to 20 button vandal resistant door panel with amplifier module and galvanized steel back box. All push buttons are stainless steel vandal and super glue resistant. Amplifier module protected with fine offset stainless steel mesh. Standard 2 characters per button engraving included.

Panel sizes 1 and 2 way	125mmW x 220mmH
Panel sizes 3 and 10 way	180mmW x 180mmH
Panel sizes 11 and 20 way	180mmW x 255mmH

**Art.520M** Power supply with 12 volts a/c, 8 volt + 12 volts d/c

**Art.3101, 3102 3000** series telephone handset wall mountable and buzzer call

Optional surface stainless steel back box

<b>100E/N</b>	1 and 2 way panels
<b>100E/NR</b>	1 and 2 way panels with rain shield
<b>100E</b>	3 to 10 way panels
<b>101E</b>	11 to 20 way panels

Add /CL to the order code if a codelock is required on the door panel.

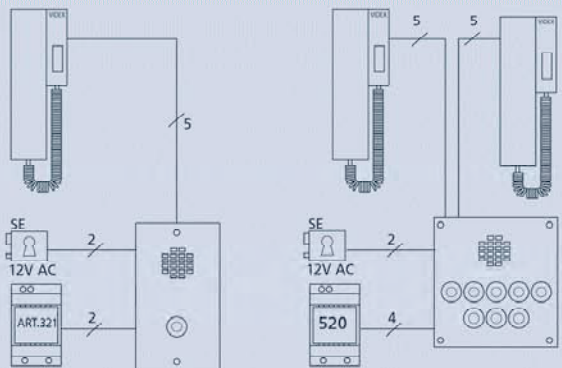
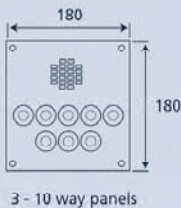
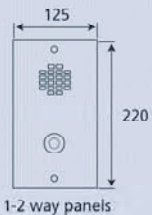



# Smart Kit

12



The circuitry of the outdoor stations provided with these kits, has a built-in lock relay to enable the electric lock. This reduces the cable requirements to only 4 wires ("3+1") between the outdoor station and the intercom and to use cables with reduced size over long distances.

## SMK-1

One button door entry kit comprised of:

**1 Art.336E-1** One call button flush mounting outdoor station complete.

**1 Art.3011** 3000 Series Smart Line wall mountable telephone with "door open" push button and electronic call tone with adjustable volume on 3 levels.

**1 Art.321** Power Supply in a type A 3 module DIN box.

Packing: box 30,5x29x7cm total weight 1,3 Kg.

## SMK-2

As the SMK-1 kit but with 2 call push buttons outdoor station (Art.336E-2) and 2 intercoms. Packing: box 41x39x7cm total weight 1,7 Kg.

## SMK-1S, SMK-2S

As the kits above but with surface mount outdoor station (Art.336E-1S, 336E-2S).

Packing: the same as above but total weight 1,5 Kg for one family version and 1,9 Kg for two button version.

For flush mounting outdoor station an optional rainshield Art.371 and surface mounting box Art.381 are available.

The outdoor station front plate and the optional rain shield are available in 3 different finishes: add /A to the product code for aluminium finish, /G for gold and /W for white. For colours see pict. 4 on page 15.

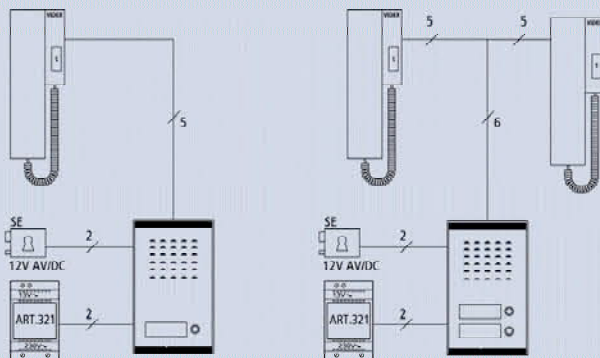
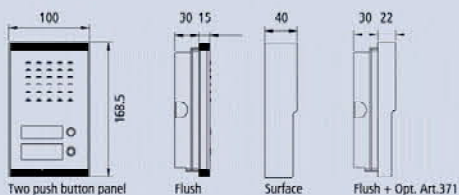

# Digiphone Kit



As 3K1 audio kit with the addition of a code lock module Art.VX800-2L.

## DK-1

One button door entry kit comprised of:

1 Outdoor station including a one button speaker module (Art.836M-1), a digital code lock (Art.VX800-2L Code lock module, 2 codes / 2 relays outputs with illumination panel), flush mounting box with module support and hinge (Art.852) plus covering frame (Art.862). Standard front plate finish in stainless steel

1 Art.3011 3000 Series Smart Line wall mountable telephone with "door open" push button and electronic call tone with adjustable volume on 3 levels.

1 Art.321 Power Supply in a type A 3 module DIN box.

Packing: box 30,5x29x7cm total weight 2,1 Kg.

## DK-2

As DK-1 but two button version with 2 call button speaker unit (Art.836M-2) and 2 intercoms.

Packing: briefcase 40x32x9cm total weight 2,8 Kg.

## DK-1S, DK-2S

As kits above but with surface mounting box Art.882.

Packing: the same as the relevant flush mount version but with total weight 2,6 Kg for one button version and 3,3 Kg for 2 button version.

For flush mounting outdoor station, an option rainshield Art.872 is available instead of the covering frame.

The outdoor station front plate is available in different finishes: standard stainless steel, aluminium /A and bronze /BZ. For colours see pict. 3 on page 15.

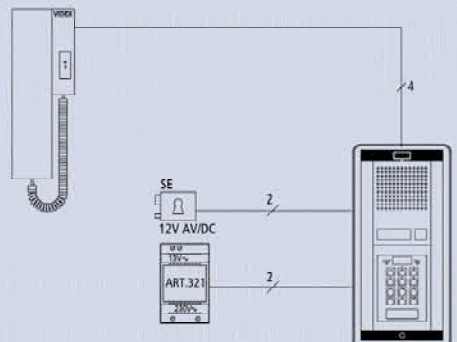
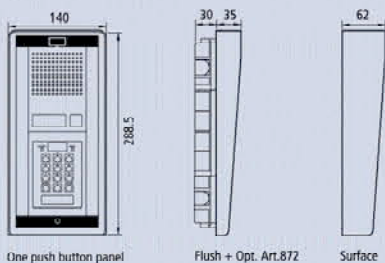

# Vprox Phone Kit - Vprox Kit

14



## VPROX PHONE KIT

As 3K1 audio kit with the addition of a Vprox proximity access control system.

**KPX947** - One button door entry kit comprised of:

1 Outdoor station including a one button speaker module (Art.836M-1), a proximity key reader module (Art.849), flush mounting box with module support and hinge (Art.852) plus covering frame (Art.862).

Standard front plate finish in stainless steel

1 **Art.3011** 3000 Series Smart Line wall mountable telephone with "door open" push button and electronic call tone with adjustable volume on 3 levels.

1 **Art.Vprox20** Vprox system CPU which will store up to 20 proximity cards Art.955/C or Tags Art.955/T.

3 **Art.955/C** proximity card (Tag Art.955/T available on request)

1 **Art.321** Power Supply in a type A 3 module DIN box.

Packing: Briefcase 40x32x9cm total weight 2,6 Kg

## KPX947-S

As kit above but with surface mounting box (Art.882). Packing: the same as above total weight 3,1 Kg.

For flush mounting outdoor station, a rainshield Art.872 is available to install instead of the covering frame.

## VPROX KIT

Access control system using a proximity key reader

**KSX947** - As kit KPX947 but without the telephone and the speaker unit.

Packing: Briefcase 32,5x26x8cm total weight 1,9 Kg

**KSX947-S** - As kit above but with surface mounting outdoor station.

Packing: the same as above total weight 2,2 Kg

For flush mounting outdoor station, a rainshield Art.871 is available to install instead of the covering frame. For finishes refer to front plate finishes.

The outdoor station front plate is available in different finishes: standard stainless steel, aluminium /A and bronze /BZ. For colours see pict. 3 on page 15.

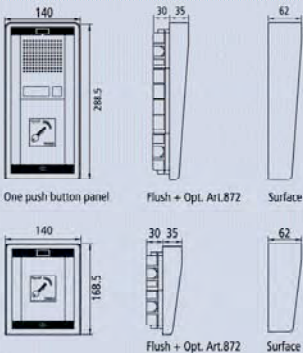

## VPROX PHONE KIT

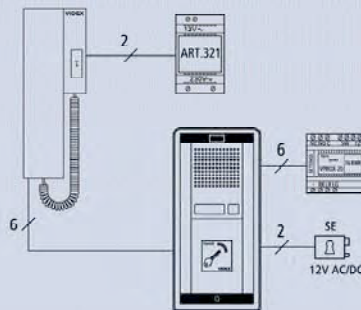

## VPROX KIT

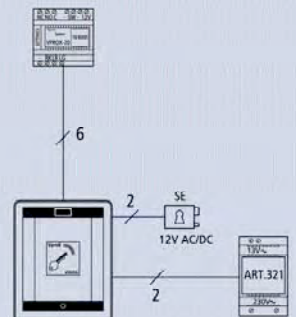



# Finishing

Ordering replacement parts, please, specify the finishes as shown here under.

## Pict. 1 - Fig. 1

Put **IG** after code for Grey finish or **IW** for White finish.

**VIDEOKIT SMART SERIES** pag. 3  
**COLOUR TV VIDEOKIT** pag. 5



## Pict. 2 - Fig. 2

When ordering other than **standard version** (Stainless Steel), put **IA** after code for Aluminium, **IW** for white, **IB** for brown or **IBZ** for bronze.

**VK6N VIDEOKIT SERIES** pag. 4  
**VIDECODE KIT** pag. 6  
**VIDEPROX KIT** pag. 7



## Pict. 3 - Fig. 3

When ordering other than **standard version** (Stainless Steel), put **IA** after code for Aluminium, **IW** for white, **IB** for brown or **IBZ** for bronze.

**3K AUDIOKIT - INTERKIT** pag. 9  
**DIGIPHONE KIT** pag. 13  
**VPROX PHONE KIT - VPROX KIT** pag. 14



## Pict. 4 - Fig. 4

Put **IA** after code for Aluminium finish, **IG** for gold or **IW** for white.

**"TWO WIRE" KIT** pag. 10  
**MINIKIT** pag. 11  
**SMART KIT** pag. 12

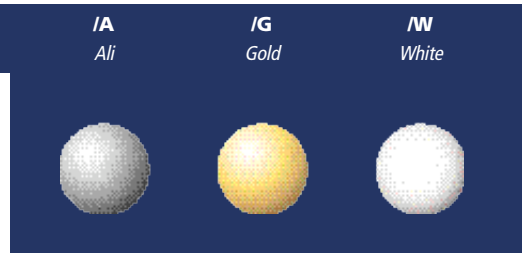



## Manufacturing Facility

At Newcastle, the 2500 square feet purpose equipped hi-tech manufacturing facility includes equipment for 24 hour soak tests and testing facilities.

## Despatch

A large despatch and stores area houses all standard product ranges. A convenient customer trade counter facility is provided at both the London and Newcastle sites.



## Training

Training is an essential element of Videx customer service from both the London and Newcastle sites. Training facilities and showrooms provide distributors, wholesalers and installers with all levels of product training.



## Technical Support

The establishment of a Technical Support line reflects the company's policy of providing the fastest response to all types of technical, product and installation enquiries. Product Build CD Software provides a unique way for distributors and contractors to build their own systems. The company's new fully interactive web-site provides comprehensive information and downloads.



London



Newcastle

## This is Videx

Videx UK was established in 1985 to promote and distribute access control and door entry equipment. Today, the company is a market leader in the design and manufacture of audio, video, door entry and access control systems. The company has an on-going programme of product improvement and enhancement along with new product development. Customers range from homeowners, to housing associations, local authorities as well as major industrial and commercial organisations.

A purpose designed Headquarters in London houses administration, showroom and training facilities. At its offices in Newcastle-upon-Tyne design, manufacture and product despatch are undertaken and there is also a state-of-the-art training and showroom facility.

Italy based Videx Electronica was formed in 1986 and today the company is represented through its offices in Greece and Denmark, as well as many distributors based throughout the world.



Italy

**Videx Security Limited**  
1 Osprey, Trinity Park,  
Trinity Way, LONDON, E4 8TD  
Tel: 0870 300 1240 Fax: 0208 523 5825

**Northern Office:**  
4-7 Chillingham Ind. Estate, Chapman Street,  
NEWCASTLE UPON TYNE, NE6 2XX  
Tel: 0870 300 1240 Fax: 0191 224 1559

**Technical Support:**  
Tel: 0191 224 3174

**Email:** [info@videx-security.com](mailto:info@videx-security.com)  
[www.videx-security.com](http://www.videx-security.com)

The Power to Secure

