

The lightning flash with an arrowhead symbol, within an equilateral triangle is intended to alert the user to the presence of uninsulated dangerous voltage within the product's enclosure that may be of sufficient magnitude to constitute a risk of electric shock to persons.



The exclamation point within an equilateral triangle is intended to alert the user to the presence of important operating and maintenance (servicing) instructions in the literature accompanying the appliance.

INFORMATION - This equipment has been tested and found to comply with limits for a Class A digital device, pursuant to part 15 of the FCC Rules & CE Rules. These limits are designed to provide reasonable protection against harmful interference when the equipment is operated in a commercial environment. This equipment generates, uses, and can radiate radio frequency energy and, if not installed and used in accordance with the instruction manual, may cause harmful interference to radio communications. Operation of this equipment in a residential area is likely to cause harmful interference in which case the user will be required to correct the interference at his own expense.

WARNING - Changes or modifications not expressly approved by the manufacturer could void the user's authority to operate the equipment.

CAUTION : To prevent electric shock and risk of fire hazards:

- ◆ Do NOT use power sources other than those specified.
- ◆ Do NOT expose this appliance to rain or moisture.

This installation should be made by a qualified service person and should conform to all local codes.

■ Contents

Features	04
Precautions	06
Components and Accessories	08
Overview	09
■ Front View	09
■ Side View	10
■ Bottom View	11
■ Rear View	12
Installation Procedures	13
■ Lens	13
· When Using Auto Iris Lens	
· When Using C/CS Mount Lens	
■ Connecting a Monitor	17
■ Connecting Power	18
■ Control via RS-485 Interface	19
■ When using UTP Cable	19

How to Use the Camera	20
■ Menu	20
■ Settings	21
· PRESETS	22
· EXPOSURE	23
· WDR	25
· WHITE BALANCE	26
· DAY&NIGHT	27
· IMAGE ADJ.	28
· SPECIAL	30
- CAMERA ID	31
- VIDEO OUT	32
- DZOOM	32
- MOTION	32
- PRIVACY MASK	33
- SYNC	34
- RS485 SETUP	35
- RESET	35
· EXIT MENU	35
Troubleshooting	36
Specifications (AC24V / DC12V)	38
Specifications (AC230V)	39

High Resolution Colour for Crisp, Clear Video

- 690TVL Effective (Colour)
- 800TVL Effective (B/W)

Wide Dynamic Range (WDR)

The camera delivers clear high quality pictures, even when backlit, by increasing exposure in dark areas while decreasing it in bright areas; a corrected image with clear details results.

- 120dB maximum dynamic range

DNR (Digital Noise Reduction)

The amount of low illuminance noise has been significantly reduced, and the signal-to-noise ratio (S/N ratio) as well as horizontal resolution, have been improved resulting in a clear and sharp image even in low light.

Filter Changeable Day & Night

This camera has a function that automatically selects the mode that is appropriate for daytime or night-time conditions. The COLOUR mode operates in daytime conditions to provide optimum colours and BW mode operates in nighttime conditions to enhance the definition of the image.

High Sensitivity for low-light images

The built-in high sensitivity PIXIM SEAWOLF Sensor enables a clear image even at 0.1Lux(COLOUR), 0.01Lux(B/W) or lower illumination.

Motion Detection

Since the camera detects motion without any additional external sensor, you can monitor activity more efficient.

Programmable GAMMA Processing

Built-in Coax and UTP video connections

RS-485 Communication Control Support

Remote OSD menu control via an RS-485 interface is supported.

Controlled by OSD Menu

The camera can be controlled by selecting text displayed on the monitor screen.

Additional Functions

SYNC (INT/LL), SENS-UP, FREEZE, FLIP (H/V-REV), D-ZOOM, SHARPNESS and PRIVACY functions are provided.

The camera requires periodic inspection.

Contact an authorised technician to carry out the inspection.

Stop using your camera when you find it malfunctioning.

If the camera emits smoke or is unusually hot for a long period, a fire may be caused.

Do not install the camera on a surface that can not support it.

If the camera is installed on an inappropriate surface, it may fall and cause injury.

Do not hold plug with wet hands.

It could cause an electric shock.

Do not dis-assemble the camera.

It may result in an electric shock or other hazards.

Do not use the camera close to a gas or oil leak.

It may result in a fire or other hazards.

■ Precautions

Do not install the camera in extreme temperature conditions.



Only use the camera under conditions where temperatures are between -10°C and $+50^{\circ}\text{C}$. Be especially careful to provide ventilation when operating under high temperatures.

Do not install the camera under unstable lighting conditions.

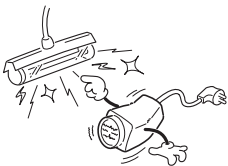

Severe lighting change or flicker can cause the camera to work improperly.

Do not install or use the camera in an environment where the humidity is high.



It can cause the image quality to be poor.

Do not touch the front lens of the camera.



This is one of the most important parts of the camera. Be careful not to leave fingerprints on the lens cover.

Do not drop the camera and protect it from physical shocks.



It can cause malfunctions to occur.

Do not expose the camera to rain or spill beverage on it.



If it gets wet, wipe it dry immediately. Liquids can contain minerals that corrode the electronic components.

Never keep the camera pointed directly at strong light.



It can damage the CMOS.

Do not expose the camera to radioactivity.



If exposed to radioactivity the CMOS will fail.

Note

- If the camera is exposed to spotlight or an object reflecting strong light, smear or blooming may occur.
- Please check the power supply satisfies the normal specification before connecting the camera.

1. Ultra High Resolution
Day&Night CMOS Camera

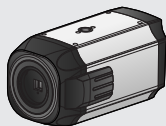

2. Auto Iris Lens Connector Plug

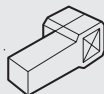

3. C-Mount Adapter



4. Instruction Manual



Front View

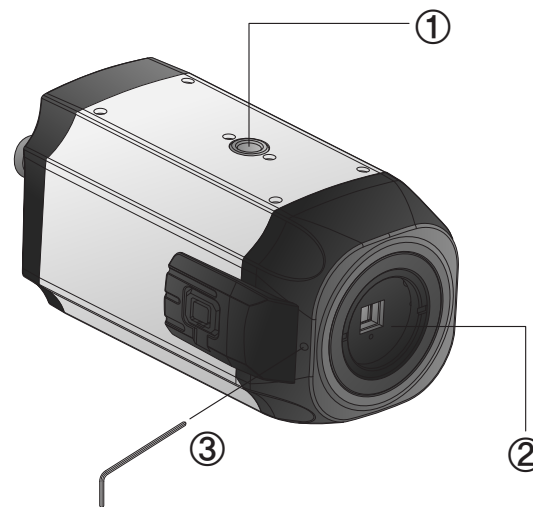

- ① **Tripod Mounting Bracket Screw Hole**
Used to fix the Tripod Mounting Bracket to the top of the camera.
- ② **C-Mount Lens Adapter**
Install this adapter to use a C-Mount Lens.
- ③ **Back Focus clamp screw**
Loosen the clamp screw with a screwdriver before adjusting the Back Focal length.

Overview

Side View

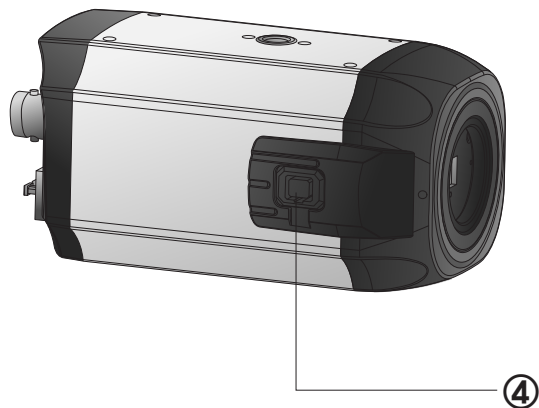

- ④ **Auto Iris Lens Connector**
Used to connect Auto Iris Lens plug.

Bottom View

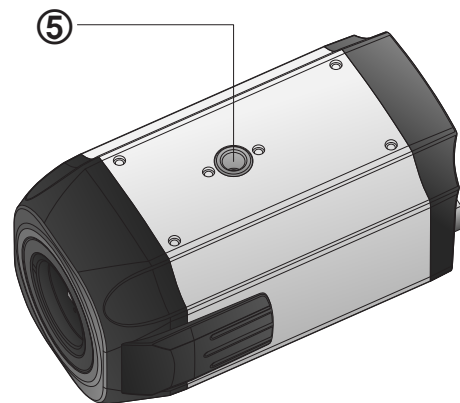

- ⑤ **Tripod Mounting Bracket Screw Hole**
Used to fix the camera on a bracket or tripod.
The screw sizes for this hole are as follows:

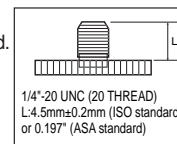

Overview

Rear View

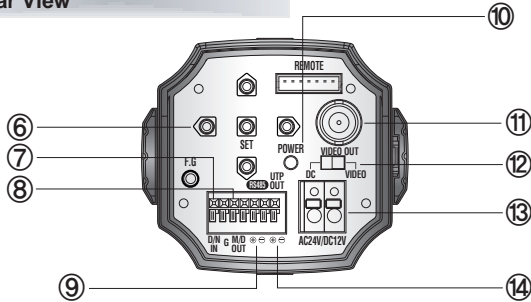

- ⑥ **Function Setup Button**
- SET Button : Displays the menu on the screen. Press this button to confirm status or after changing a selected item.
 - Up and Down Button : Used to move the cursor up or down in the menu screen to select a desired menu item.
 - Left and Right Button : Used to move the cursor left or right in the menu screen or to change the value of the selected item.
- ⑦ **D & N Input Port (GND : BW, Open : Colour)**
You can switch to Day & Night Mode by connecting an external signal to this port.
- ⑧ **MD Output Port**
Motion detection signals are output through this port.
- 0V 3±0.5sec +4.0V ~ +4.5V (less than 10mA)
There is motion There is motion
- ⑨ **RS-485 Control Port**
You can control SETUP MENU through this port by using external controllers like a Remote controller that RS-485 Communication is supported. For details, see page 19.
- ⑩ **Power LED**
When power is properly connected, this LED comes on.
- ⑪ **Video OUT Port (Coaxial Cable)**
Video signals are output through this port. Connect this port to the Video IN port of a monitor.

Installation Procedures

- ⑫ **Auto iris lens selection switch**
Change the mode to DC or VIDEO depending on the type of auto iris lens being used.
- ⑬ **Power IN Port**
Connect the power as specified for each model here.
- ⑭ **Video OUT Port (UTP Cable)**
For details, see page 19.

Lens

The lens is not supplied with this camera. Purchase a lens suitable for your environment. This camera accepts the auto iris lens and both C-and CS-mount lens.

Note

- It is recommended to use the DC type Auto Iris Lens to effectively enjoy the major functions of this camera.
- Keep the lens surface clean, since if it is contaminated with dirt or fingerprints the picture quality suffers.

When Using Auto Iris Lens

1. Strip the insulation of the auto iris lens cable 8mm from the end..

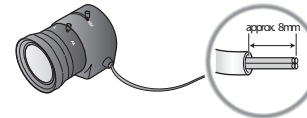

2. Strip the insulation of the core of the auto iris lens cable to expose a 2mm length.

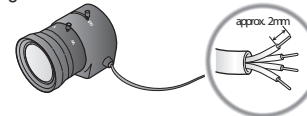

■ Installation Procedures

3. Remove the cover of the auto iris lens connector plug and solder the lens cable to the connector pin of the plug.

• For a Video Drive Lens

Pin 1: Red (Power)
Pin 2: NC
Pin 3: White (Video Signal)
Pin 4: Black (Ground)

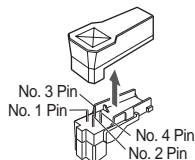

• For a DC Drive Lens

Pin 1: Damping -
Pin 2: Damping +
Pin 3: Drive +
Pin 4: Drive -

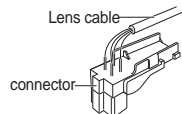

4. Fit the cover of the auto iris lens connector plug, remove the protective cover from the front of the camera, and fasten the auto iris lens by turning it clockwise.

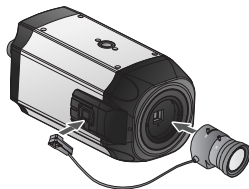

When Using C/CS Mount Lens

Before installing a lens, identify whether the lens to be installed is a C-Mount or CS-Mount. This camera is set for a CS-Mount Lens by default. To install a C-Mount Lens, a simple modification is required.

• When Using a CS Mount Lens

Remove the protective glass cover at the front of this product and turn the CSMount Lens clockwise to install it. And set focus of camera using Back Focus Control Lever of camera side after combining CS-Mount lens.

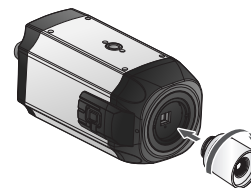

Note

• Use the lens connector shown in the following figure. If the dimensions of the connector are not correct, it may damage the camera, or the lens may not be installed firmly.

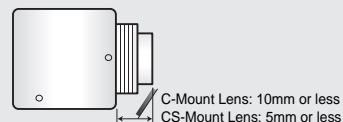

- If the lens is too heavy, the camera becomes unbalanced and there may be problems. Use a lens that weighs less than 450g.
- When adjusting the Automatic Level Control (ALC) of an auto iris lens, use Av mode if available. If you use the Pk mode, the picture brightness may change continuously.

■ Installation Procedures

• When Using a C Mount Lens

1. Remove the protective cover at the front of this product and turn the CMount Adapter clockwise to install it.

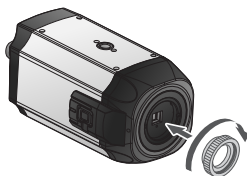

2. Turn the C-Mount lens clockwise to install it.

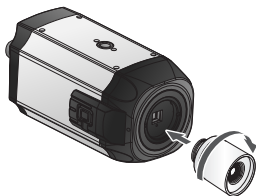

3. Set focus of camera using Back Focus Control Lever of camera side after combining C-Mount lens.

Connecting to a monitor

Connect the video output terminal located on the rear of the camera to the monitor.



- Since the connection procedure may differ depending on the type of monitor or peripheral device to be connected, refer to the User Manual for the device to be connected.
- Make sure to turn off the device to be connected before making any connections.
- Turn the 75Ω/Hi-Z switches of interim display devices to the Hi-Z position, and the switches of any final device to the 75Ω position.

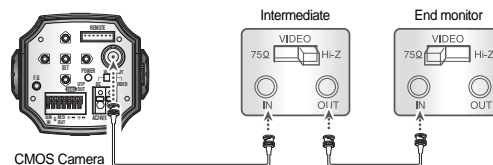

■ Installation Procedures

Connecting Power

Since power specifications differ depending on the model, make sure to check your model name and specifications before connecting power. You can connect power as shown in the following figure.

For AC / DC power

- Check the standard power requirement before connecting to power.

Dual Power Type
(AC 24V/DC 12V, AC 24V Class2)
DC Power Type (DC 12V, 500mA)

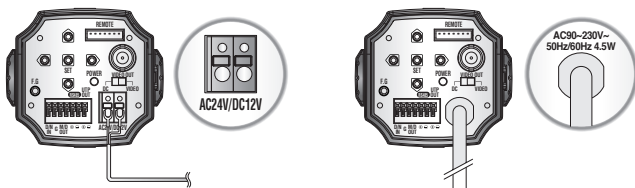

When the resistance value of copper wire is at [20°C(68°F)]

Copper wire size(AWG)	#24(0.22mm ²)	#22(0.33mm ²)	#20(0.52mm ²)	#18(0.83mm ²)
Resistance value(/m)	0.078	0.050	0.030	0.018
Voltage drop(V/m)	0.028	0.018	0.011	0.006

- As shown in the table above, voltage decreases as the wire gets longer. Therefore use of an excessively long adaptor output line for connection to the camera may affect the performance of the camera.

※ Standard voltage for camera operation : DC 12V±10%, AC 24V±10%
 ※ There may be some deviation in voltage drop depending on the type of wire and the manufacturer.

Control via RS-485 Interface

The camera can be controlled by using an external controller equipped with RS-485 communications.

- To control using a DVR or keyboard controller
 Connect the RS-485 cable (TRX+, TRX-) to the connection port of the 485 control board in the DVR or controller.

485 Control Board Connection Port	RS-485 Control Port
(+) CONNECTION TERMINAL (TRX+)	485+
(-) CONNECTION TERMINAL (TRX-)	485-

* RS-485 communication default initial values

Item	Camera ID	BAUD RATE
Initial value	1	2400

Note

- To control the camera use Pelco-D protocol.
 - Set Preset 95 : Enters into OSD menu.
 - Iris Open command : Set key function.
 - Iris Close command : Cancel function.

When using UTP Cable

- Connect UTP (Unshielded Twisted Pair) directly to the UTP output of this camera. The camera contains a passive UTP Balun.
- A UTP receiver, either passive or active, is needed at the Monitor or DVR to connect your UTP cable.
- When connecting the UTP cable make sure the video signal is transmitted over one pair of wires and the polarity is correct.
- Only use Category 5e/6 24 awg cable.

How to Use the Camera

Menu

SETUP menu			
PRESETS	· NORMAL · BACKLIGHT	· INDOOR	· OUTDOOR
EXPOSURE	· LENS SELECT · EXPOSURE MODE · DNR · COLOR ROLL		· BLC · AGC · HIGHLIGHT · SENS-UP
WDR	· MIDDLE · LOW	· HIGH	· USER
WHITE BALANCE	· ATW · AWB	· INDOOR · MANUAL	· OUTDOOR
DAY&NIGHT	· AUTO · EXTERNAL	· COLOR	· BW
IMAGE ADJ.	· FREEZE · COLOR GAIN	· FLIP · GAMMA	· SHARPNESS · FOCUS
SPECIAL	· CAMERA ID · MOTION · RS485 SETUP	· VIDEO OUT · PRIVACY MASK · RESET	· DZOOM · SYNC
EXIT MENU	· VERSION · CANCEL	· SAVE&EXIT	· DEFAULT

Settings

Settings can be made using the 5 buttons on the rear of the camera.

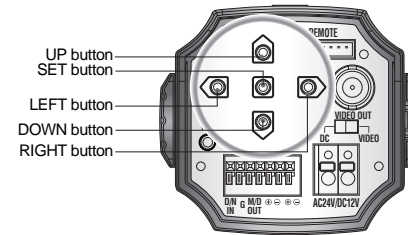

1. Press the SET button
 - Settings can now be made. The SETUP menu is displayed on the monitor.

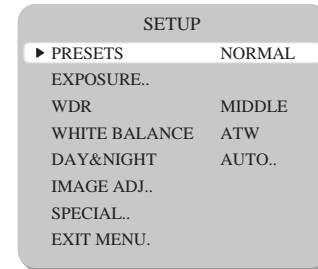

2. Select a menu item from the list available by using the UP and DOWN buttons.
 - Functions are selected using up and down buttons.
 - The selected position is displayed in blue.

How to Use the Camera

Select the function using the UP or DOWN button.

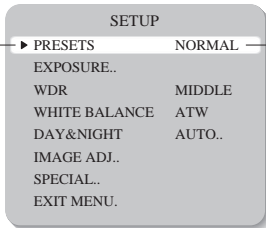

Change the status using the LEFT or RIGHT button.

- Set up a selected item by using the Left and Right buttons.
- To finish and save the settings, select 'EXIT MENU' and press the SET button.



Note

- An item with the .. icon also has sub-menus. To select a sub-menu, press the SET button.

PRESETS

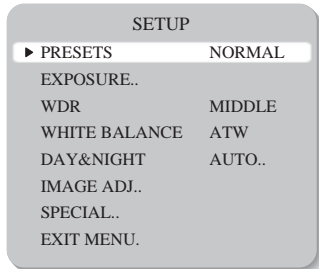

- **NORMAL** : Normal environment.
- **INDOOR** : Indoor environment.
- **OUTDOOR** : Outdoor environment.
- **BACKLIGHT** : Backlight environment.

EXPOSURE

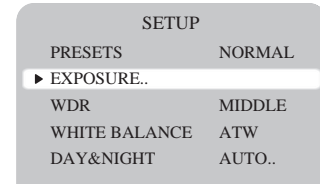

When the SETUP menu screen is displayed, select 'EXPOSURE' by using the Up and Down buttons so that the arrow indicates 'EXPOSURE'.

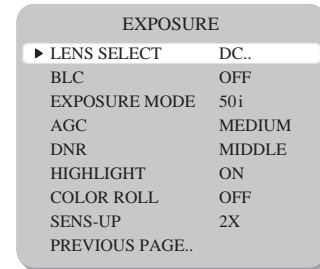

- **LENS SELECT** : Using this function, you can control the screen brightness.
 - DC / VIDEO / Manual : Select Lens Type

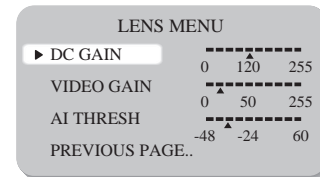

How to Use the Camera

- **BLC** : To optimize the scene when there is a strong backlight behind the object.
- ON / OFF selectable

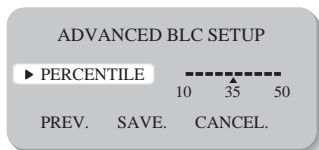

- **EXPOSURE MODE** : To select the number of fields and number of exposure cycles.
- 50i/25p selectable
- **AGC (AUTO GAIN CONTROL)** : In dark environments, the higher the gain level, the brighter the screen but the higher the noise.
- OFF / LOW / MEDIUM / HIGH selectable
- **DNR (Digital Noise Reduction)** : The level of background noise in low light decreases automatically as the level of gain changes.
- OFF / LOW / MIDDLE / HIGH selectable
- **HIGHLIGHT** : To optimise the scene when high dynamic range lighting is detected.
- ON : bright parts of the image are most visible.
- OFF : dark parts of the image are most visible.
- **COLOR ROLL** : To control a detector that finds colour fluorescent roll.
- OFF / LOW / HIGH selectable
- **SENS-UP** : When it is night or dark, the camera automatically detects the light level and maintains a clear picture if this mode is activated.
- 2X, 4X, 8X, 16X, 32X
- OFF : Deactivates the SENS-UP function.

WDR

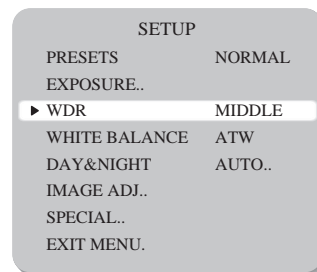

- **WDR** : When the image has simultaneous bright and dark areas, the Wide Dynamic Range makes both areas distinct.
- LOW / MIDDLE / HIGH / USER selectable

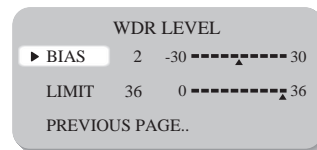

How to Use the Camera

WHITE BALANCE

Use the White Balance function to adjust the screen colours.

1. Position the cursor to point to WHITE BAL on the SETUP menu screen, select using the Up and Down buttons.
2. Select the desired mode using the Left and Right buttons.

SETUP	
PRESETS	NORMAL
EXPOSURE..	
WDR	MIDDLE
▶ WHITE BALANCE	ATW
DAY&NIGHT	AUTO..
IMAGE ADJ..	
SPECIAL..	

※Select one of the following 5 modes, as appropriate.

- **ATW** : The ATW mode continuously monitors.
- **INDOOR** : Select when the colour temperature is between 4000°K and 8500°K
- **OUTDOOR** : Select when the colour temperature is between 2000°K and 11000°K
- **AWB** : To obtain the optimum state under the current luminance levels, direct the camera to point toward a sheet of white paper and press the SET button. If the environment changes, including the light source, the white balance will require re-adjustment.
- **MANUAL** : Select to "fine-tune" the White Balance manually. Set White Balance first using the ATW or AWB mode. Afterwards switch to MANUAL mode, fine-tune the White Balance and then press the SET button.

MANUAL WHITE BALANCE	
▶ RED	-18 -20 ▬-----20
BLUE	13 -20 -----▬20
PREVIOUS PAGE.	

Note

• Under the following conditions White Balance may not work properly. In such cases, select the AWC mode.

- ① When the colour temperature of the subject environment has a very high temperature range (e.g. clear sky, or sunset)
- ② When the ambient illumination of the subject is low.
- ③ If the camera is directed toward a fluorescent light, or is installed in a place where illumination changes dramatically, the White Balance operation may become unstable.

DAY&NIGHT

SETUP	
PRESETS	NORMAL
EXPOSURE..	
WDR	MIDDLE
WHITE BALANCE	ATW
▶ DAY&NIGHT	AUTO..
IMAGE ADJ..	
SPECIAL..	
EXIT MENU.	

- **AUTO** : This camera has an IR Cut-Filter and automatically changes to the appropriate mode according to lighting levels. To set up the switching time for the AUTO mode press the SET button.

How to Use the Camera

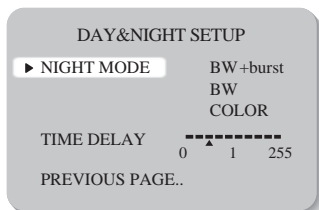

- **COLOR** : The picture is displayed in colour.
- **B/W** : The picture is always displayed in black and white.
- **EXTERNAL** : This mode allows the application of a filter to external signals.

IMAGE ADJ.

When the SETUP menu screen is displayed, select 'IMAGE ADJ.' using the Up and Down buttons.

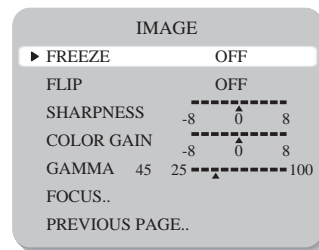
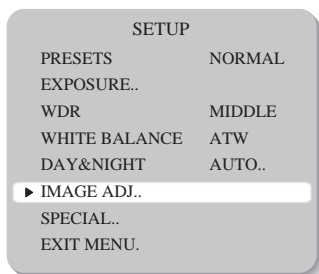

- **FREEZE** : View still pictures.
 - OFF / ON selectable
- **FLIP** : OFF / HORIZ / VERT / BOTH selectable

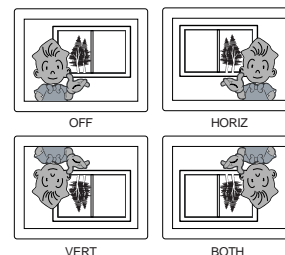

- **SHARPNESS** : The outline of the video image becomes cleaner and more distinctive as the level of SHARPNESS increases. If the level goes up excessively, however, it may affect the video image and generate noise.
 - The available range of level is -8 ~ 8
- **COLOR GAIN** : To control the colour level in the video.
 - The available range of level is -8 ~ 8
- **GAMMA** : Users can change the gamma setting between 25 and 100

How to Use the Camera

- **FOCUS** : To adjust the lens focus.

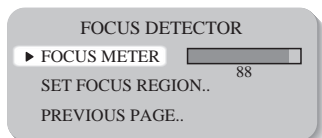

SPECIAL

When the SETUP menu screen is displayed, select 'SPECIAL' by using the Up and Down buttons so that the arrow indicates 'SPECIAL'.

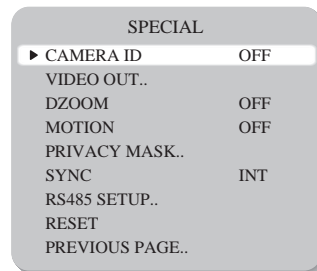
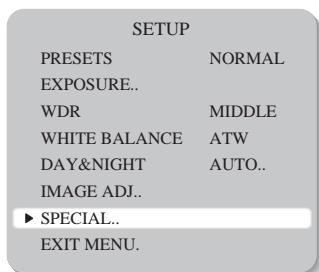

- **CAMERA ID** : User can enter a unique name for the respective camera. The maximum length of the ID is ten characters.
 - You can choose the ON and OFF with the selector. If you select ON, the entered camera ID is displayed at the selected position in the video picture (normal operation).
 - Please select the setup button while in On mode.
 - Select the desired position with the selector.

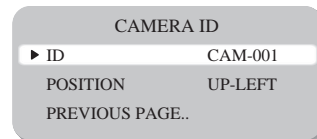

- ① Move the cursor to the letter required by using the Set-Up button.
- ② Select an ID from A,B-Y,Z, a,b-y,z, 0,1-8,9 by using the LEFT and RIGHT buttons.
- ③ Repeat the above steps until the ID is complete.

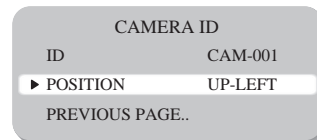

How to Use the Camera

- ① Select the position where the ID is to be displayed by using the LEFT and RIGHT buttons.

- **VIDEO OUT** : Move the cursor to select the video system
 - VIDEO STANDARD : You can control NTSC / PAL, Video level, Sync level, Burst level.

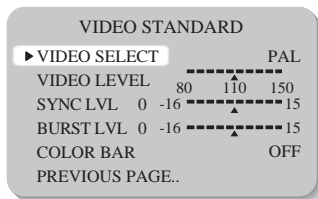

- **DZOOM** : Digital P/T/Z are used to create a zoom lens effect. Zoom Factor (1X to 4X), Pan ($\pm 100\%$, center of image can be moved to left and right edges of screen), Tilt ($\pm 100\%$, center of image can be moved to top and bottom edges of screen)

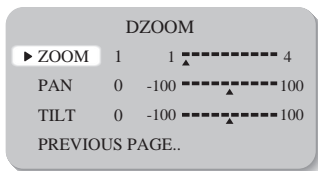

- **MOTION** : This product has a feature that allows you to observe movements of objects in on the screen, hence a single individual can conduct supervision efficiently. The camera detects an object's movement by sensing disparity of outline, and level of brightness and colour.

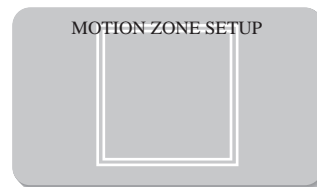
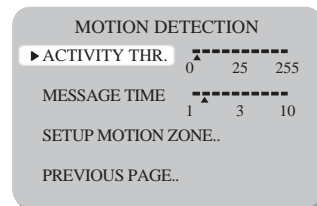

- White : MOTION ZONE Position movement
- Green : MOTION ZONE Size enlargement
- Red : MOTION ZONE Size reduction
- For MOTION ZONE Confirm, long press SET button

- **PRIVACY MASK** : Hide an area you want to hide on the screen.

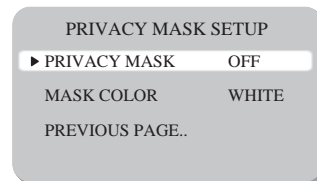

■ How to Use the Camera

ENABLE MASKS (1 to 6)

▶ MASK 1	ON
MASK 2	OFF
MASK 3	OFF
MASK 4	OFF
MASK 5	OFF
MASK 6	OFF
PREV. NEXT.	

ENABLE MASKS (7 to 12)

▶ MASK 7	OFF
MASK 8	OFF
MASK 9	OFF
MASK 10	OFF
MASK 11	OFF
MASK 12	OFF
PREVIOUS PAGE..	



- White : PRIVACY-ZONE Position movement
- Blue : PRIVACY-ZONE Size enlargement or reduction
- For PRIVACY-ZONE Confirm, long press SET button

- **SYNC** : Two synchronisation modes are available, INTERNAL and EXTERNAL LINELOCK. In LINE-LOCK mode, it synchronises the video signal between cameras without a synchronous generator. The line-lock synchronisation is only used in areas of 60Hz (NTSC) / 50Hz (PAL).

- INT : Internal synchronisation
- LL : External line-lock synchronisation
 - If 'LL' is selected, it can be adjusted to the desired phase. Press the SET button.

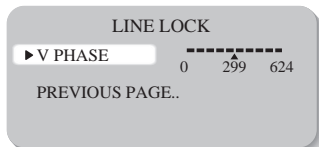

- Adjust to the desired phase from 0 to 624.

- **RS485 SETUP** : This function sets up the camera communication status when controlling the camera through an external control device.

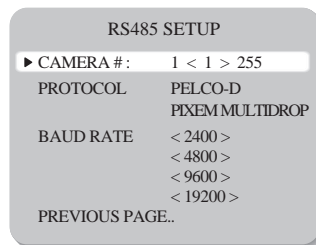

- **RESET** : Resets the camera.

EXIT MENU.

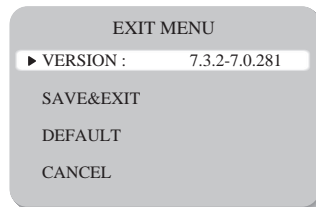

- **VERSION** : 7.3.2-7.0.281
- **SAVE&EXIT** : Saves all the setting menus and then exits.
- **DEFAULT** : Resets the camera settings to the factory defaults.
- **CANCEL** : Cancel to the camera settings.

■ Troubleshooting

If you have trouble operating your camera, refer to the following table. If the guidelines do not enable you to solve the problem, contact an authorised technician.

Problem	Solution
Nothing appears on the screen.	<ul style="list-style-type: none"> • Check the power connections. • Check the VIDEO signal line connection.
The image on the screen is dim.	<ul style="list-style-type: none"> • Make sure the lens is clean. Clean the lens with a soft clean lint free cloth. • Adjust the monitor contrast & brightness controls. • Re-position the camera if necessary.
The image on the screen is dark.	<ul style="list-style-type: none"> • Adjust the contrast control of the monitor. • If you have an intermediate device, set the 75Ω / Hi-z properly.
The camera is not working properly, and the surface of the camera is hot.	<ul style="list-style-type: none"> • Check that an appropriate power source is connected to the camera.
The Motion Detection function does not work.	<ul style="list-style-type: none"> • Check that MOTION DET in the SPECIAL SETUP is not set to 'OFF'.

Problem	Solution												
Colour is not correct.	<ul style="list-style-type: none"> • Check the WHITE BAL settings in the SETUP menu. 												
The screen flickers continually.	<ul style="list-style-type: none"> • Check that the camera is not facing toward the sun. 												
RS-485 communication fails.	<ul style="list-style-type: none"> • Check the polarity between the RS-485 Control Port and the RS-485 cable. <table border="1" data-bbox="1114 449 1485 507"> <thead> <tr> <th>485 Control Board Connection Port</th> <th>RS-485 Control Port</th> </tr> </thead> <tbody> <tr> <td>(+) CONNECTION TERMINAL (TRX+)</td> <td>485+</td> </tr> <tr> <td>(-) CONNECTION TERMINAL (TRX-)</td> <td>485-</td> </tr> </tbody> </table> • Check the RS-485 Communication default settings. <table border="1" data-bbox="1114 591 1485 630"> <thead> <tr> <th>Item</th> <th>Camera ID</th> <th>BAUD RATE</th> </tr> </thead> <tbody> <tr> <td>Initial value</td> <td>1</td> <td>2400</td> </tr> </tbody> </table> <p>* RS-485 Communication default settings are :</p>	485 Control Board Connection Port	RS-485 Control Port	(+) CONNECTION TERMINAL (TRX+)	485+	(-) CONNECTION TERMINAL (TRX-)	485-	Item	Camera ID	BAUD RATE	Initial value	1	2400
485 Control Board Connection Port	RS-485 Control Port												
(+) CONNECTION TERMINAL (TRX+)	485+												
(-) CONNECTION TERMINAL (TRX-)	485-												
Item	Camera ID	BAUD RATE											
Initial value	1	2400											

■ Specifications (AC24V / DC12V)

ITEM	SPEC.
Power Consumption	350mA (AC24V) / 490mA (DC12V) 420mA (DC12V Only)
Image Sensor	PIXIM 1/3" High Sensitivity Digital Sensor
Signal processing	17-bit Digital Signal Processing
Transfer Format	Progressive with Segmented Frames
Sync. System	Internal / Line Lock
Effective Pixels	758(H) x 540(V)
Dynamic Range	120dB(Max), 102dB(Typical)
Horizontal Resolution	690TVL Effective (Colour), 800TVL Effective (B/W)
Min. Illumination	0.1Lux (Colour), 0.01Lux (B/W)
Day & Night	AUTO / COLOR/ B/W / EXTERNAL
White Balance	ATW / AWB / INDOOR / OUTDOOR / MANUAL
WB Range	2000°K~11,000°K
Shutter Speed	up to 1/30, 720 sec
Sens-up	AUTO / OFF (Selectable x2 ~ x32)
Privacy Masking	12 Zones
Remote Control	RS-485
AGC	OFF / LOW / MEDIUM / HIGH
Image Flip	OFF / HORIZ / VERT / BOTH
Camera ID	ON / OFF
S/N Ratio	More than 50dB
Video Output	Composite video output 75 ohm terminated
UTP	Built-in
OSD	Built-in
Operating Humidity	30% ~ 90% RH
Operating Temp.	-10°C to 50°
Weight	Approx. 400g

※ POWER OPTION - DC12V Only : DN83TSPX/12

Specifications (AC230V) ■

ITEM	SPEC.
Power Consumption	AC230V MAX. 4.5W
Image Sensor	PIXIM 1/3" High Sensitivity Digital Sensor
Signal processing	17-bit Digital Signal Processing
Transfer Format	Progressive with Segmented Frames
Sync. System	Internal / Line Lock
Effective Pixels	758(H) x 540(V)
Dynamic Range	120dB(Max), 102dB(Typical)
Horizontal Resolution	690TVL Effective (Colour), 800TVL Effective (B/W)
Min. Illumination	0.1Lux (Colour), 0.01Lux (B/W)
Day & Night	AUTO / COLOR/ B/W / EXTERNAL
White Balance	ATW / AWB / INDOOR / OUTDOOR / MANUAL
WB Range	2000°K~11,000°K
Shutter Speed	up to 1/30, 720 sec
Sens-up	AUTO / OFF (Selectable x2 ~ x32)
Privacy Masking	12 Zones
Remote Control	RS-485
AGC	OFF / LOW / MEDIUM / HIGH
Image Flip	OFF / HORIZ / VERT / BOTH
Camera ID	ON / OFF
S/N Ratio	More than 50dB
Video Output	Composite video output 75 ohm terminated
UTP	Built-in
OSD	Built-in
Operating Humidity	30% ~ 90% RH
Operating Temp.	-10°C to 50°
Weight	Approx. 400g

※ POWER OPTION - AC230V Only : DN83TSPX/240

■ MENU



**Model : DN83TSPX
DN83TSPX/12
DN83TSPX/240**

PIXIM True Day/Night Bodied Camera

Instruction Guide



GENIE CCTV LTD.

CCTV House, City Park, Watchmead, Welwyn Garden City, Hertfordshire, AL7 1LT

Tel : +44 (0) 1707 330541 Fax : +44 (0) 1707 330543

www.geniecctv.com



Edition. GN-APRIL 2012