



DG502

Y2K
COMPLIANT

STAND-ALONE PROXIMITY SYSTEM 500 PROXIMITY BADGES 2 DOORS

WIRING DIAGRAM AND INSTRUCTIONS

Wiring diagram
PCB front view

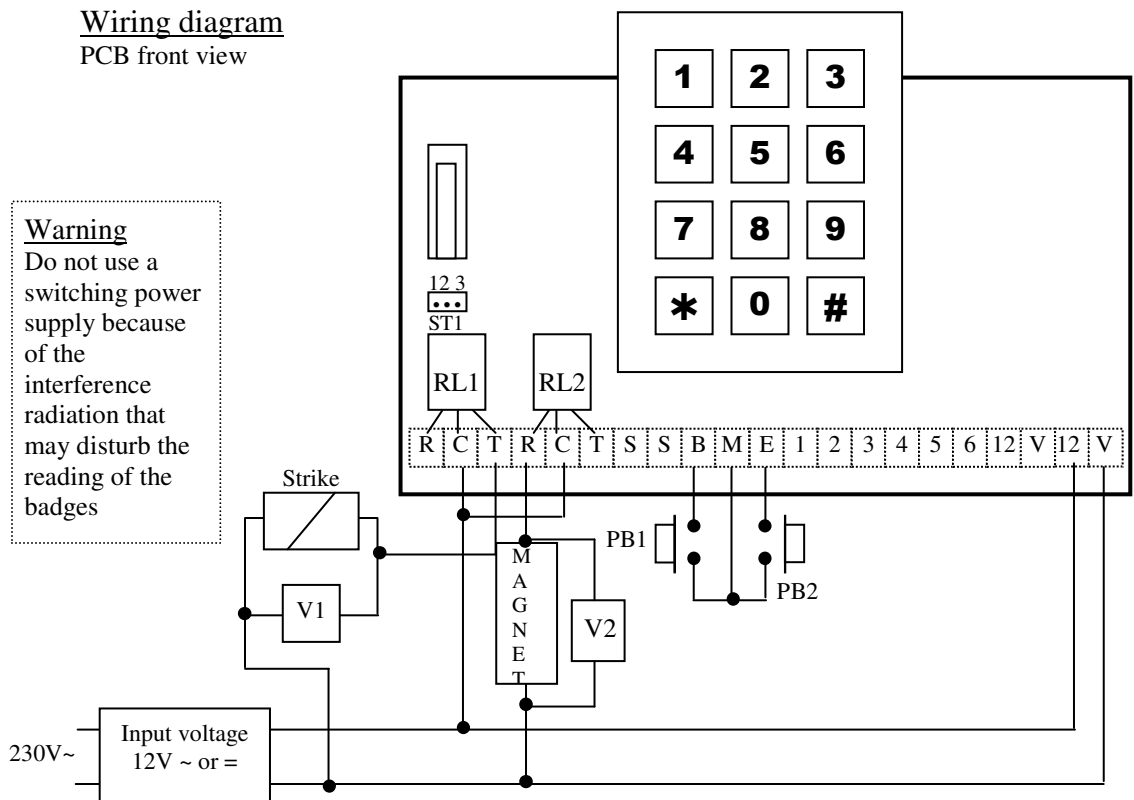

Warning
Do not use a switching power supply because of the interference radiation that may disturb the reading of the badges

B	Push button 1
E	Push button 2
M	Common PB1 PB2
R	N/C contact
C	Common
T	N/O contact
V1	Varistor RL1
V2	Varistor RL2
ST1	Reset jumper
S, S	Trigger output
RL1	Door 1 relay output
RL2	Door 2 relay output

12	Input voltage
V	Input voltage
1	Data
2	Buzzer
3	Green LED
4	Common
5	Red LED

Auxiliary reader
(terminal connections)
See wiring diagram of auxiliary readers

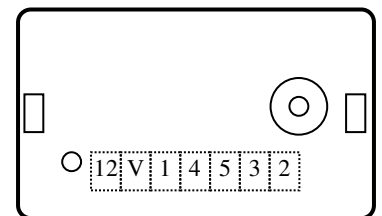

This device comes with a varistor.
The varistor must be connected to the strike terminal (electromagnet...) operated by the device.
If this product works with many strikes, each of them should have a varistor.
The varistor controls the overload produced by the strike coil – self-effect.

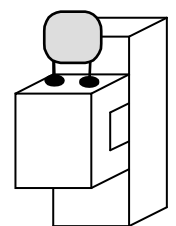

If you are using a « Shear Lock » electromagnetic lock, it is recommended to use a separate power supply than the one connected to the **DG502** !



Technical features

Input voltage	12V ~ or =
Output	2 relays, N/O & N/C contact 3 amp @ 125V
Anti-triggering contact	500 milli amp 50V ~ or =
Badge entry	500 programmable badges
Master code	5-digit programmable code
Inputs	2 request-to-exit
Keyboard	12-digit keypad with built-in buzzer (audible signal)
Distance between the auxiliary reader and the main reader	minimum 60 cm, maximum 50 m (cable minimum 7 x 0.6 mm ²)

Warning: Do not use a switching power supply because of the interference radiation that may disturb the reading of the badges.

Default values

Master code:	12345
Relay time delay:	1 second
Key-in keypad:	10 seconds

Audible signals

1 beep (long)	Validation of data in programming mode: master code, proximity badge or time delay. Or access code validated
2 beeps (short)	Accessing the programming mode or going out from the programming mode
4 beeps (short)	Badge not programmed or incorrect master code, time delay entered

Visual signals

LED colour	Normal mode	Programming mode
Green	Door relay activated	Badge position empty
Red	Alarm relay activated	Badge position busy
Orange		Programming mode
Orange flashing	Stand-by	Data computing error

Request-to-exit

The two request-to-exit push button PB1 and PB2 operate relay RL1 and RL2. The LED becomes green when the relay is activated by one of the push button.



Setting a new master code

1. Enter the master code twice (for the first use the master code default value is 12345). 2 beeps and the orange LED lights on confirming that you are in programming mode.
2. Enter *3 then the 5-digit new master code. The LED goes off for 1 second and an audible beep indicates that the new master code is memorised.
3. Press # to exit from the programming mode. 2 beeps confirm that you are back to the reading mode.

4 beeps indicate a data computing error.

Setting Time delays

Enter the master code twice (for the first use the master code default value is 12345). 2 beeps and the orange LED lights on confirm the entry in programming mode.

Programming modes and operating	Enter *0, then 00 for a local programming mode (proximity) The main reader is the only one to operate the programming. Enter *0, then 01 for a remote programming mode (magstripe) The auxiliary reader 1 is the only one to operate programming In normal mode (reading mode), when set in local programming mode all readers can be used, in a remote programming mode only the auxiliary readers operate. LED 1 goes off for 1 second and an audible beep indicates the validation of the programming.
Door relay 1	Enter *1, then the time delay in seconds : 01 equals 1 second up to 99 for 99 seconds. 00 corresponds to latched output. The LED goes off for 1 second and an audible beep indicates the validation of the time delay.
Door relay 2	Enter *2, then the time delay in seconds : 01 equal 1 second up to 99 for 99 seconds. 00 corresponds to latched output. The LED goes off for 1 second and an audible beep indicates the validation of the time delay.

Press # to exit from programming mode. 2 beeps confirm that you returned to reading mode.

4 beeps indicate a data computing error.

Setting new proximity badges

1. Enter the master code twice (for the first use the master code default value is 12345). 2 beeps and the orange LED lights on to confirm that you have entered into the programming mode.
2. Enter the badge position number to be programmed (000 to 499). The LED goes off for 1 second and audible beeps are activated.
3. If the green LED is on, present the badge in front of the main reader. The LED goes off for 1 second and an audible beep is emitted. The orange LED lights on to confirm that badge has been memorised.
4. If the red LED is on (this badge position number is already taken), cancel the old badge before programming a new one, or go to a new position.
5. To exit from the programming mode at any time press #. 2 beeps confirm that you have returned to the reading mode.



Cancelling or replacing programmed badges

1. Enter the master code twice (for the first use the master code default value is 12345). 2 beeps and the orange LED lights on to confirm that you have entered into the programming mode.
2. Enter the badge position number (000 to 499). The LED goes off for 1 second and an audible beep is emitted.
3. The red LED lights on indicating that the badge position number is taken.
4. Press the key star twice (**). The LED goes off for 1 second and an audible beep is emitted.
5. The green LED lights on indicating that the badge is cancelled.
6. Press # to exit from the programming mode.

OR

7. Present the new badge in front of the main reader. The LED goes off for 1 second and an audible beep is emitted.
8. The orange LED lights on to indicate that the new badge was saved.
9. To exit from the programming mode press #. 2 beeps confirm that you have returned to the reading mode.

Reset the master code and the badges

1. Put the jumper ST1 to position 2-3.
2. The green LED blinks for 5 seconds. An audible beep confirms that the master code has been reset to the default value 12345. The red LED will blink to indicate the default is restored.
3. Take off the jumper from position 2-3 to go back to a normal mode.

OR

4. Keep the jumper on position 2-3 to reset all the proximity badges.
 5. The red LED blinks for 5 seconds then stays on during the reset.
 6. When the reset is completed the red LED goes off.
- Take off the jumper from position 2-3 to go back to normal mode.

Relay outputs

The main unit and the auxiliary reader 1 operate relay 1 and auxiliary reader 2 operates relay 2.

Wiring diagram of the auxiliary readers

The auxiliary reader 1 is connected according to the schematic on page 6 – terminal 1 of the main reader to terminal 1 of the auxiliary reader 1.

For the second reader, terminal number 6 of the main reader must be wired to terminal number 1 from auxiliary reader 2.

The auxiliary readers can be operated by a separate power supply or by using the 12 V output from the DG502.

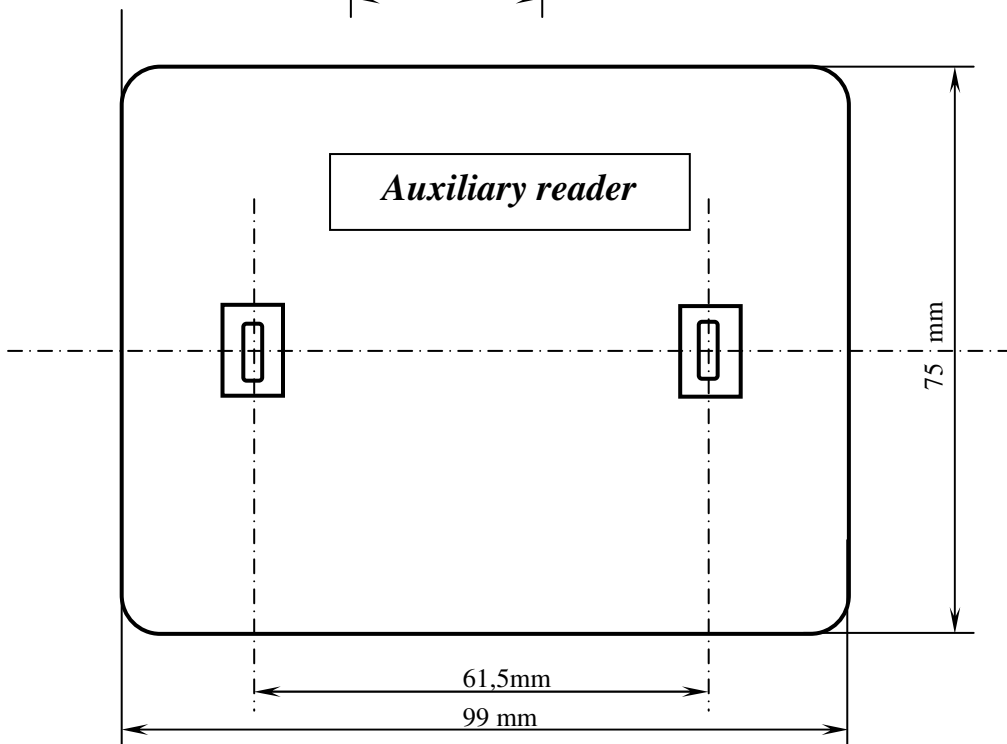
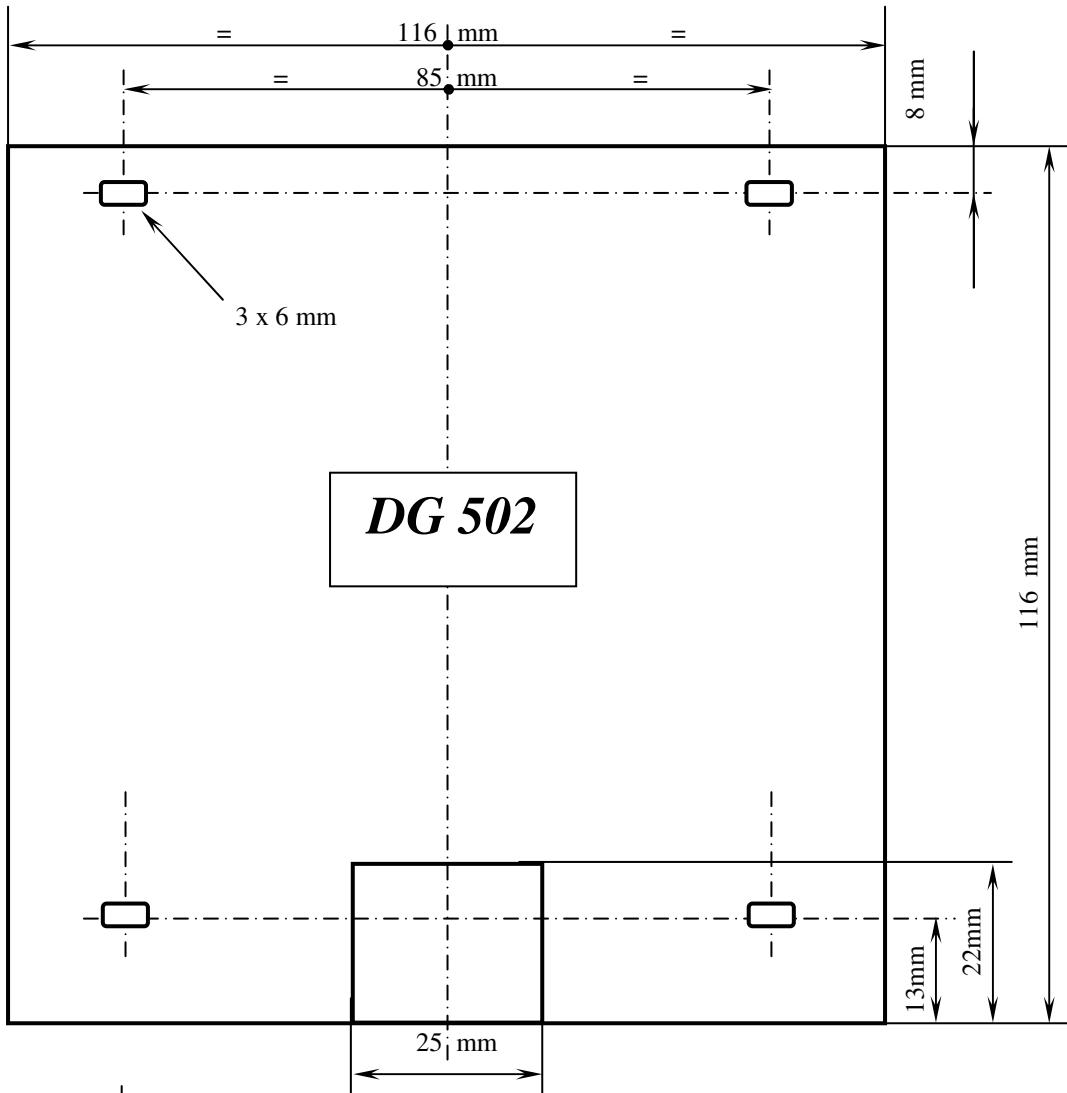



Wiring diagram of auxiliary reader 1

DG502

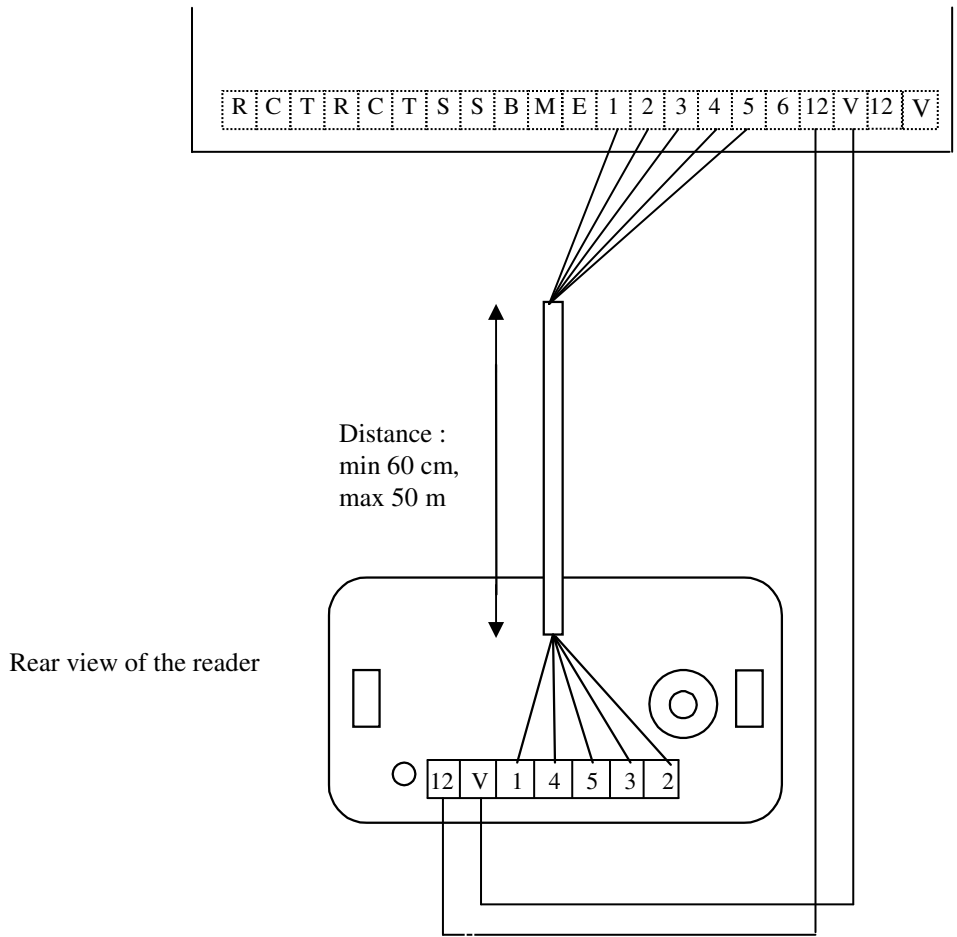

Wiring between DG502—Reader 1		
DG502		Reader 1
12	Input voltage	12
V	Input voltage	V
1	Data	1
2	Buzzer	2
3	Green LED	3
4	Common	4
5	Red LED	5



Wiring diagram auxiliary reader 2

DG502

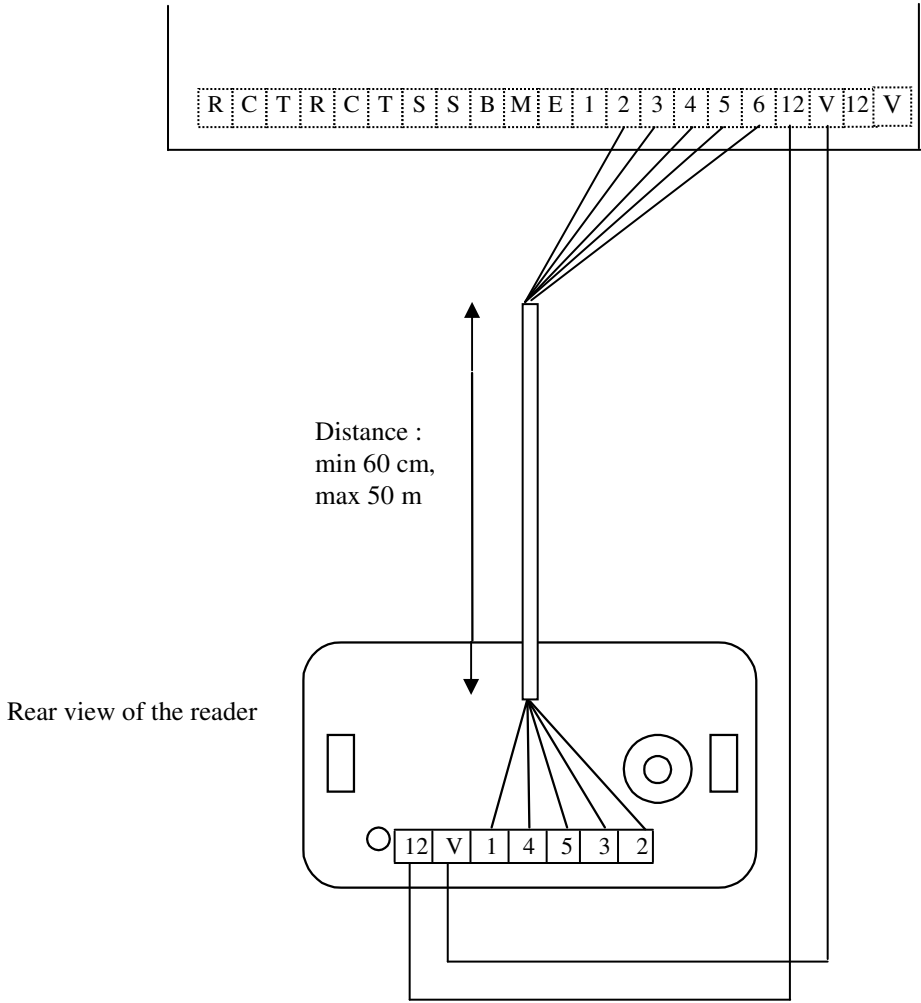

Wiring between DG502—Reader 2		
DG502		Reader 2
12	Input voltage	12
V	Input voltage	V
6	Data	1
2	Buzzer	2
3	Green LED	3
4	Common	4
5	Red LED	5



Wiring diagram magnetic stripe reader 1

