



Audio POLYX

344082

Description

2 WIRE handsfree handset for wall mounted installation.
It's fitted with keys for: EP activation/cycling, door lock release, staircase light switching on and 4 programmable keys, which operating mode is set through the configuration. Specific audible and visual signals mean that it is also suitable for use by disabled people. Fixing bracket supplied.

Technical data

Power supply from SCS BUS: 18 – 27 Vdc
Stand by absorption: 5 mA
Max. operating absorption: 55 mA
Operating temperature: 5 - 40°C

Dimensional data

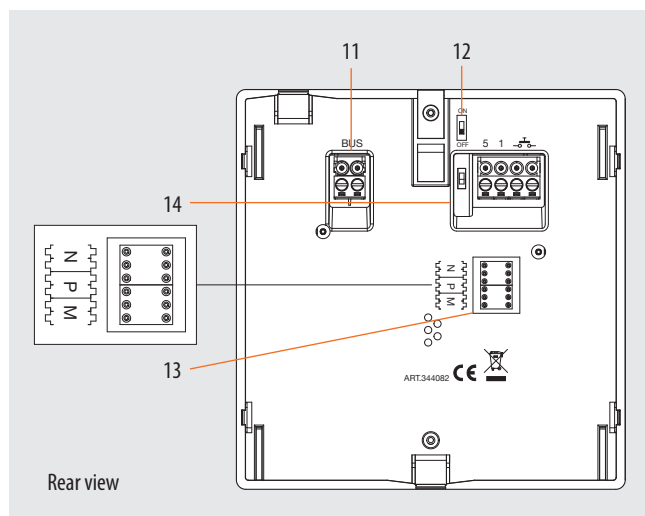
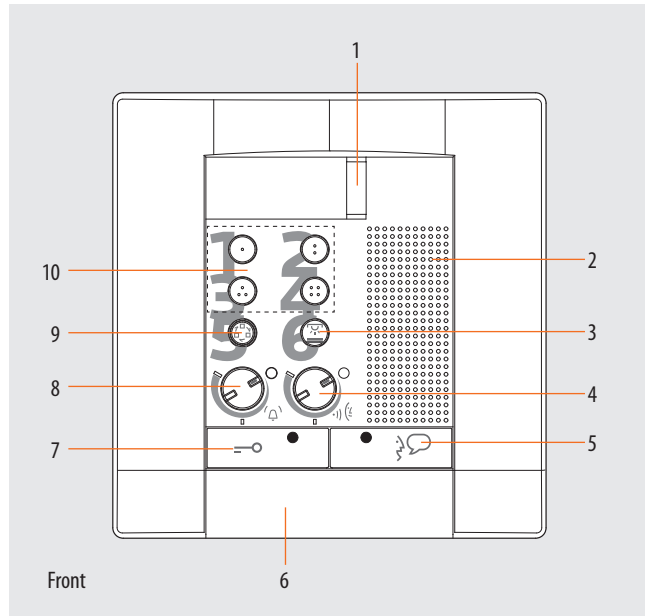
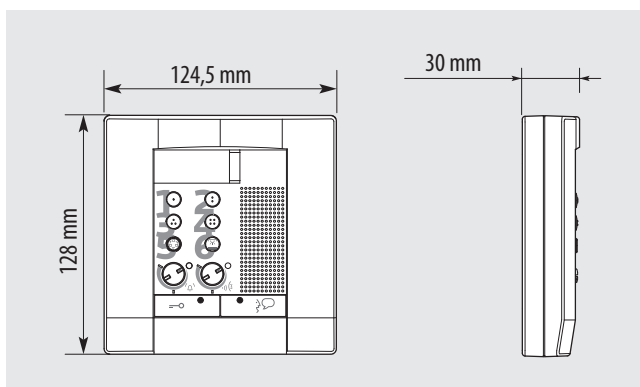

Legend



- 1 - Call signalling LED
- 2 - Loudspeaker
- 3 - Staircase light key
- 4 - Loudspeaker volume adjustment
- 5 - Connection key+ LED
- 6 - Microphone
- 7 - Door lock key + LED
- 8 - Bell volume adjustment and exclusion + LED
- 9 - EP Activation/cycling
- 10 - 4 programmable keys (through configuration)
- 11 - Clamps for the connection to the 2 WIRE BUS
- 12 - Line termination ON/OFF micro-switch
- 13 - Configurator socket
- 14 - Clamps for the connection of the Floor call auxiliary services and extra bell

Configuration







N - handset number

Assigns to each handset an identification number within the system. The handsets must be configured in progressive order. Handsets with parallel connection (max 3 are allowed inside apartments without item 346850) must be configured using the same N configurator.

P - entrance panel association

The P configurator identifies the associated EP, or the first entrance panel on which the audio is activated when the  key is pressed, as well as which door lock is activated when the key  is pressed while the handset is idle.

M - Operating mode of the keys

In addition to the door lock opening key  and the staircase light key , the handset also has 4 programmable keys ( -  -  - .

These keys may be associated to different operating modes (e.g. activation of external actuators, intercom, activation of additional EPs, etc., based on the type of configurator connected to M).

Configurator in P	key  function
0-9	Entrance panel audio activation (configured with P=0-9)

Configurator in P	key  function
0-9	Opening of the EP door lock (configured with P=0-9)

The handset offers the possibility to select among 16 types of bells with pre-programmed ringtones, which can be associated to the following type of calls:

- Calls from the entrance panel (configured with S=0 - S=4)
- Calls from the entrance panel (configured with S=0 - S=5)
- Intercom call
- Floor call

(See the bell programming table in the following pages)











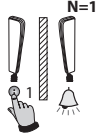

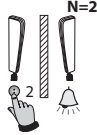
Configuration

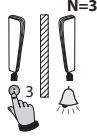
Below are the various operating modes that can be assigned to the 4 programmable keys:

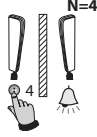
MODE	KEY	FUNCTION	NOTES
MOD =		1 Intercom on itself, it sends the call to all handsets with the same address.	
		2 EP activation (configured with P+1), directly, without call, or activation of the actuator, item 346200 (configured with P+1 and MOD=9)	
		3 EP door lock release (configured with P+1), directly, without call, or activation of the actuator, item 346200 (configured with P+1 and MOD=5), or activation of door lock actuators 346230-346260 (configured with P+1)	
		4 EP door lock release (configured with P+2), directly, without call, or activation of the actuator, item 346200 (configured with P+2 and MOD=5), or activation of door lock actuators 346230-346260 (configured with P+2)	
MOD =		1 Intercom on itself, it sends the call to all handsets with the same address.	
		2 Intercom inside the apartment, in systems with apartment interface item 346850, or intercom among apartments without apartment interface.	
		3 EP activation (configured with P+1), directly, without call, or activation of the actuator, item 346200 (configured with P+1 and MOD=9)	
		4 EP door lock release (configured with P+1), directly, without call, or activation of the actuator, item 346200 (configured with P+1 and MOD=5), or activation of door lock actuators 346230-346260 (configured with P+1)	
MOD =		1 Intercom inside the apartment, in systems with apartment interface item 346850, or intercom among apartments without apartment interface.	
		2 Intercom inside the apartment, in systems with apartment interface item 346850, or intercom among apartments without apartment interface.	
		3 EP door lock release (configured with P+1), directly, without call, or activation of the actuator, item 346200 (configured with P+1 and MOD=5), or activation of door lock actuators 346230-346260 (configured with P+1)	
		4 EP door lock release (configured with P+2), directly, without call, or activation of the actuator, item 346200 (configured with P+2 and MOD=5), or activation of door lock actuators 346230-346260 (configured with P+2)	

MODE	KEY	FUNCTION	NOTES
MOD = 3		1 Intercom inside the apartment, in systems with apartment interface item 346850, or intercom among apartments without apartment interface.	
		2 Intercom inside the apartment, in systems with apartment interface item 346850, or intercom among apartments without apartment interface.	
		3 Intercom inside the apartment, in systems with apartment interface item 346850, or intercom among apartments without apartment interface.	
		4 Intercom inside the apartment, in systems with apartment interface item 346850, or intercom among apartments without apartment interface.	
MOD = 4		1 EP activation (configured with P+1), directly, without call, or activation of the actuator, item 346200 (configured with P+1 and MOD=9)	
		2 Intercom inside the apartment, in systems with apartment interface item 346850, or intercom among apartments without apartment interface.	
		3 EP door lock release (configured with P+1), directly, without call, or activation of the actuator, item 346200 (configured with P+1 and MOD=5), or activation of door lock actuators 346230-346260 (configured with P+1)	
		4 EP door lock release (configured with P+2), directly, without call, or activation of the actuator, item 346200 (configured with P+2 and MOD=5), or activation of door lock actuators 346230-346260 (configured with P+2)	
MOD = 5		1 EP door lock release (configured with P+1), directly, without call, or activation of the actuator, item 346200 (configured with P+1 and MOD=5), or activation of door lock actuators 346230-346260 (configured with P+1)	
		2 EP door lock release (configured with P+2), directly, without call, or activation of the actuator, item 346200 (configured with P+2 and MOD=5), or activation of door lock actuators 346230-346260 (configured with P+2)	
		3 EP door lock release (configured with P+3), directly, without call, or activation of the actuator, item 346200 (configured with P+3 and MOD=5), or activation of door lock actuators 346230-346260 (configured with P+3)	
		4 EP door lock release (configured with P+4), directly, without call, or activation of the actuator, item 346200 (configured with P+4 and MOD=5), or activation of door lock actuators 346230-346260 (configured with P+4)	

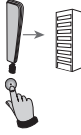
MODE	KEY	FUNCTION	NOTES
MOD = 6	1	Activation of the scenario saved in the scenario module	(SCENARIO 1)
	2	Activation of the scenario saved in the scenario module	(SCENARIO 2)
	3	EP door lock release (configured with P+1), directly, without call, or activation of the actuator, item 346200 (configured with P+1 and MOD=5), or activation of door lock actuators 346230-346260 (configured with P+1)	
	4	EP door lock release (configured with P+2), directly, without call, or activation of the actuator, item 346200 (configured with P+2 and MOD=5), or activation of door lock actuators 346230-346260 (configured with P+2)	
MOD = 7	1	Intercom inside the apartment, in systems with apartment interface item 346850, or intercom among apartments without apartment interface.	
	2	Intercom inside the apartment, in systems with apartment interface item 346850, or intercom among apartments without apartment interface.	
	3	Activation of the scenario saved in the scenario module	(SCENARIO 1)
	4	Activation of the scenario saved in the scenario module	(SCENARIO 2)
	5	Activation of the scenario saved in the scenario module	(SCENARIO 3)
MOD = 8	1	Activation of the scenario saved in the scenario module	(SCENARIO 1)
	2	Activation of the scenario saved in the scenario module	(SCENARIO 2)
	3	Activation of the scenario saved in the scenario module	(SCENARIO 3)
	4	Activation of the scenario saved in the scenario module	(SCENARIO 4)
MOD = 1	1	General Intercom , sends a call to all the handsets of the system.	
	2	EP activation (configured with P+1), directly, without call, or activation of the actuator, item 346200 (configured with P+1 and MOD=9)	
	3	EP door lock release (configured with P+1), directly, without call, or activation of the actuator, item 346200 (configured with P+1 and MOD=5), or activation of door lock actuators 346230-346260 (configured with P+1)	
	4	EP door lock release (configured with P+2), directly, without call, or activation of the actuator, item 346200 (configured with P+2 and MOD=5), or activation of door lock actuators 346230-346260 (configured with P+2)	
MOD = 12	1	Intercom between apartments, in systems with apartment interface, item 346850	
	2	Intercom between apartments, in systems with apartment interface, item 346850	
	3	EP door lock release (configured with P+1), directly, without call, or activation of the actuator, item 346200 (configured with P+1 and MOD=5), or activation of door lock actuators 346230-346260 (configured with P+1)	
	4	EP door lock release (configured with P+2), directly, without call, or activation of the actuator, item 346200 (configured with P+2 and MOD=5), or activation of door lock actuators 346230-346260 (configured with P+2)	

MODE	KEY	FUNCTION	NOTES
MOD = 13		1 Intercom between apartments, in systems with apartment interface, item 346850	
		2 Intercom between apartments, in systems with apartment interface, item 346850	
		3 Intercom between apartments, in systems with apartment interface, item 346850	
		4 Intercom between apartments, in systems with apartment interface, item 346850	
MOD = 16		1 Activation of the scenario saved in the scenario module	(SCENARIO 1)
		2 Activation of the scenario saved in the scenario module	(SCENARIO 2)
		3 General Intercom , sends a call to all the handsets of the system.	
		4 EP door lock release (configured with P+1), directly, without call, or activation of the actuator, item 346200 (configured with P+1 and MOD=5), or activation of door lock actuators 346230-346260 (configured with P+1)	

Configuration

A			B	C	D	E
0	0	+ 20 = B 40 = C 60 = D 80 = E	20	40	60	80
1	0		30	50	70	90
0	1		21	41	61	81
0	2		22	42	62	82
1	2		32	52	72	92
0	3		23	43	63	83
1	3		33	53	73	93
0	4		24	44	64	84
0	5		25	45	65	85
0	6		26	46	66	86
1	6		36	56	76	96
0	7		27	47	67	87
0	8		28	48	68	88

- Ⓐ Configuration selected for the operation of the keys (see previous pages)
- Ⓑ Configuration selected for the operation of the keys + **OFFICE** function
- Ⓒ Configuration selected for the operation of the keys + **PAGING** function
- Ⓓ Configuration selected for the operation of the keys + **HANDSFREE** function (**Can be activated only on a single device for each unit system**)
- Ⓔ Configuration selected for the operation of the keys, **OFFICE and PAGING** function

OFFICE FUNCTION DETAIL

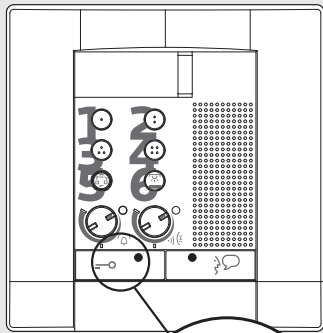

With the function active, when a call is received from the entrance panel, the video handset rings and the associated door lock is automatically released, without the need for pressing the door lock release key on the handset.

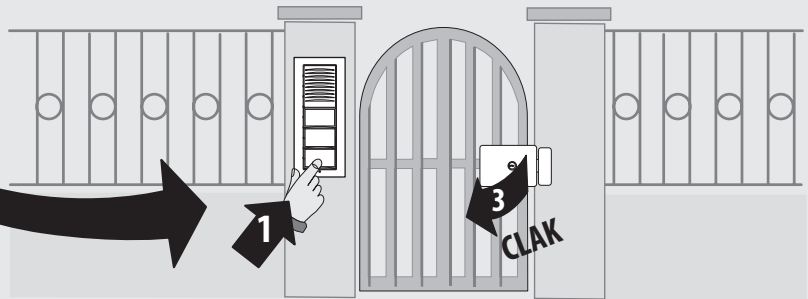
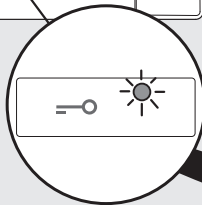
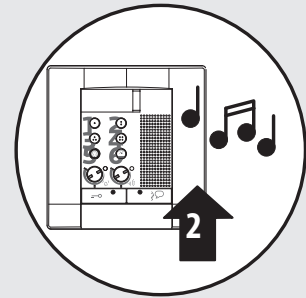

To ENABLE the function

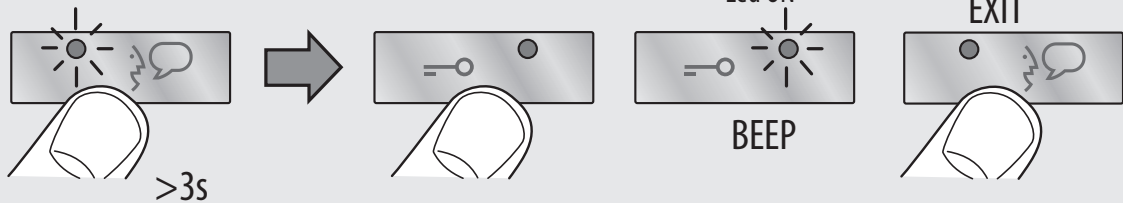

To DISABLE the function

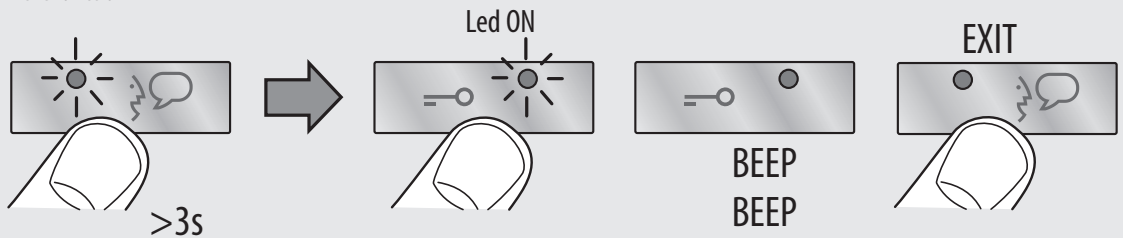

⚠ WARNING: the "OFFICE" function cannot be activated together with the "DOOR STATUS" function.

DOOR STATUS function

This function notifies the status of the door lock. If open, the “door lock LED” flashes, if closed, the LED stays off.

NOTA: è attivabile solo se l’impianto lo prevede; NON è attivabile contemporaneamente alla OFFICE function.

PAGING function

This function can be used to send voice messages using the microphone of the device through the speakers of the sound system. To activate briefly press the “Connection” key while the device is in the idle condition. The activation of the function is confirmed by the green LED coming on. To DISABLE the function press the “Connection” key again.

PUSH TO TALK function

If the entrance panel is in a particularly noisy position, during the conversation it will be possible to enable the “PUSH TO TALK” function, which will provide a better quality of communication.

To enable the PUSH TO TALK function during the conversation proceed as follows:

- Press the Connection key for at least 2 seconds, to enable the communication with the entrance panel.

The LED stays green.

- Release the key to listen to the entrance panel. **The LED turns red.**
- To end the connection press the Connection key briefly. **The LED turns off.**

HANDSFREE function

The HANDSFREE function automatically activates the microphone and the loudspeaker when a call is received, without the need for pressing the Connection key to answer (the connection is automatically established when the call is received).

To ENABLE the function

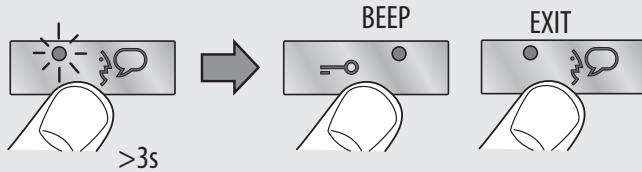

To DISABLE the function

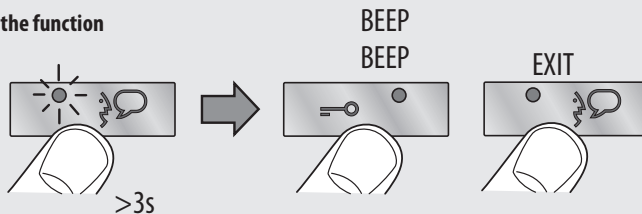

Enable/disable key sound

In the base configuration, when a key is pressed, a beep is emitted. This function may be disabled/enabled with the following procedure:

To ENABLE the function

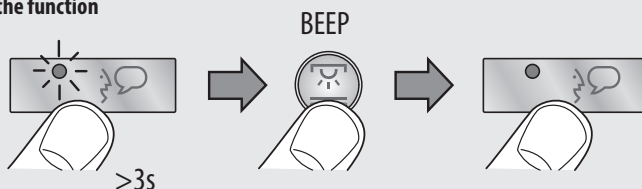

To DISABLE the function

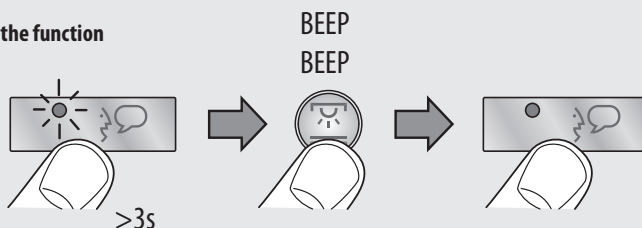

Programming of bells

Bell selection from MAIN ENTRANCE PANEL (S=0)

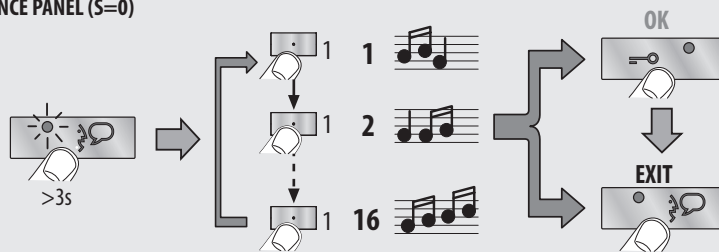

Bell selection from SECONDARY ENTRANCE PANEL (S=1)

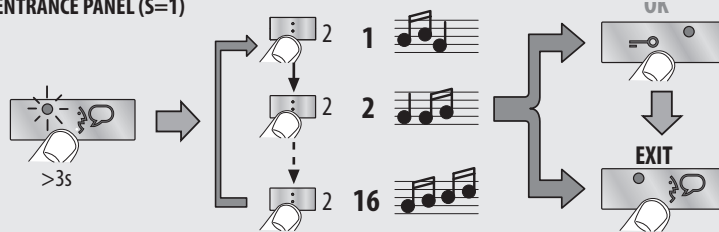

INTERCOM CALL bell selection

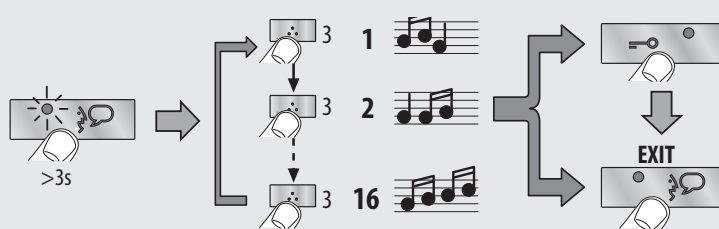

**EXTERNAL INTERCOM CALL bell selection
(only with interface item 346850)**

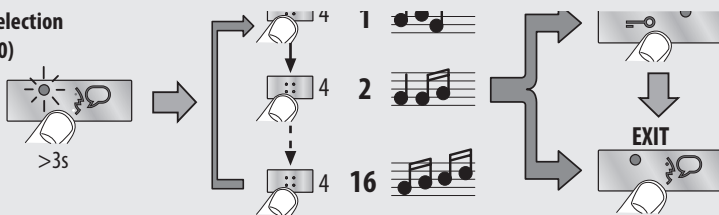

FLOOR CALL bell selection

