



**JM Series**  
*Touchscreen Intercom*

# JM Series *Touchscreen Intercom*

## A Perfect Solution!

The JM Series can be installed at 4 doors and connect to 8 inside stations with internal communication between inside stations. Perfect for any application, anywhere.



### COMMERCIAL (OFFICES)



Conveniently and safely identify visitors from any inside station. Place multiple stations around the office to ensure every visitor is attended to in a timely manner. The master station can automatically record visitor images onto an SD / SDHC card for future accessibility. Connect the system to CCTV cameras for additional surveillance capabilities.

### RESIDENTIAL (SINGLE FAMILY HOMES)

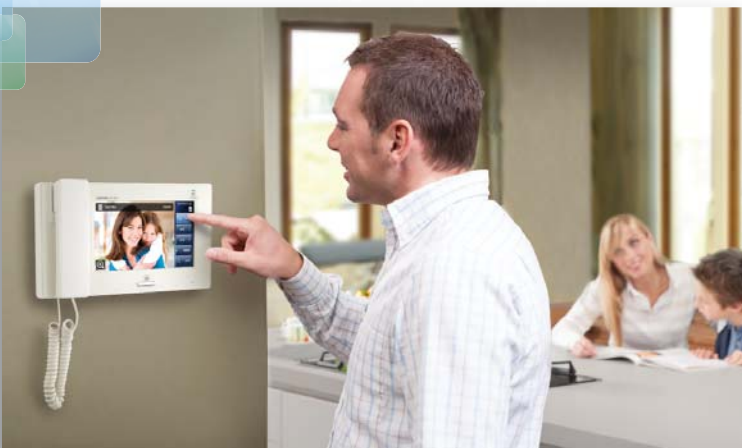

The sleek and modern design of the JM Series master station complements today's homes and lifestyles. In addition, the JM Series comes equipped with three alarm inputs. These can be used to alert residents of potential threats, emergencies, or home damage.

### SCHOOLS



Lock school entrances to maintain security by identifying visitors and unlocking doors safely and conveniently from the main office or principal's desk.

### HOSPITALITY



For hotels, hospitals, senior living facilities, or any location that restricts building access during the night or day, the JM Series provides a convenient way to unlock the door for guests or authorized visitors.

### RETAIL & DINING



Keep delivery or alley entrances locked while being able to easily identify visitors. See who is on the other side of the door from inside the establishment and conveniently unlock doors from any inside station.

**7" Touchscreen**

# Touchscreen Simplicity!

The 7" touchscreen displays clear images from the door station. Know exactly who is at the door, even from across the room. The touchscreen interface replaces the traditional button design for easy operation and simplicity.

Flexible communication – all-in-one device!



## Hands-free (One Touch)

Simply touch the screen and easily communicate with visitors using the built-in microphone and speaker.

Applications: Offices, Homes



## Handset

Need privacy? Just pick up the handset at any time during conversation. It is perfect for high-volume environments!

Applications: Healthcare, Schools

## Upgrading is a snap!

Door stations connect to the JM Series master station (JM-4MED) using standard 2-wire cable. Use existing wiring, including doorbell wire, to upgrade to a JM Series system. Once doors are connected to the master station, all sub master stations are connected using CAT-5e/6.

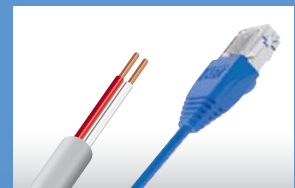



# Inside Stations *(Master & Sub Master Stations)*



**7" Touchscreen**

## Use the JM Series touchscreen to easily navigate between functions.

Oversized buttons and intuitive icons allow for quick navigation and control of JM Series functions such as door release and station monitoring.

## Sophisticated design.

Conventional push buttons have been replaced with touchscreen graphics to create a simple and modern station design.



## Internal Communication

### All Call

Simultaneously make an announcement to all inside stations.



### Selective Call

Choose a single inside station to call.



AIPHONE JM-4MED

STATUS



Actual size. Screen image simulated.

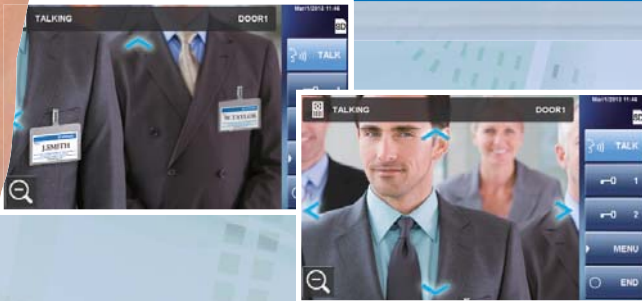

## Zoom in for detail.

The JM Series inside stations control the door station's wide angle camera to observe more activity behind the door. In addition, digital PanTilt and Zoom can focus on an area for greater detail.

## Record images to an SD\* or SDHC\* card!

The JM-4MED features picture memory to record visitors. See who stopped by, when away from the building. Picture memory records images of visitors to internal memory. Insert an SD/SDHC card\* to increase the picture memory frame rate. Easily remove the card to view images on a computer or other SD/SDHC display device.

*\*SD and SDHC cards sold separately*



 After a call is placed, the JM Series records 6 images per call to internal memory.

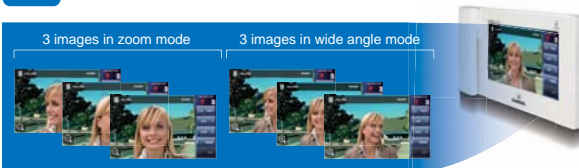

 If an SD / SDHC card\* is set as the primary storage location, recording frequency increases to 4 images per second for up to 10 seconds per call.

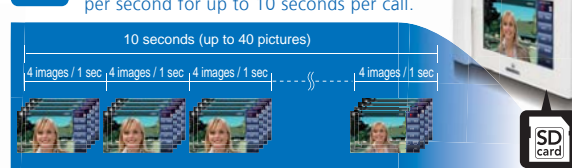



# Door Stations

## Get the Whole Picture with 170° Video Camera Door Stations

Easily identify all visitors, regardless of height, with the door station wide angle camera.

Using a 170° wide angle and 100° vertical angle camera minimizes blind spots, ensuring a clear view of the door station area.



### See images clearly day and night

The JM Series is equipped with an advanced light adjustment feature to compensate for varying light levels. If the image is too dark, use the ADJUST feature to increase brightness at the door station.

Before adjustment

After adjustment

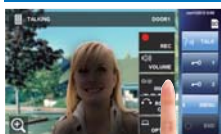

#### Day time with strong backlight

In situations where a strong backlight prevents the user from properly identifying their visitor, a simple adjustment using the touchscreen interface can correct and brighten the visitor's image.

Before adjustment

After adjustment

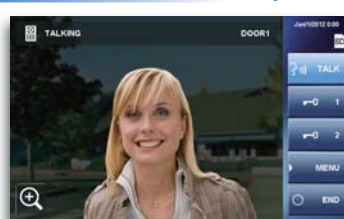

#### Night time with low light

During low light situations, the door station LEDs can be turned on to illuminate the visitor or to more clearly monitor activities taking place around the door station.



## Partitioning for a secure building.

The JM Series allows for system partitioning to control interaction and authority between stations. Easily designate a certain master station to only communicate and unlock a particular door or set of doors. In addition, the system calling zones can be created between master stations for quick communication channels.

Partitioning is password protected at each master station to guarantee unauthorized users do not intentionally or accidentally compromise building safety.

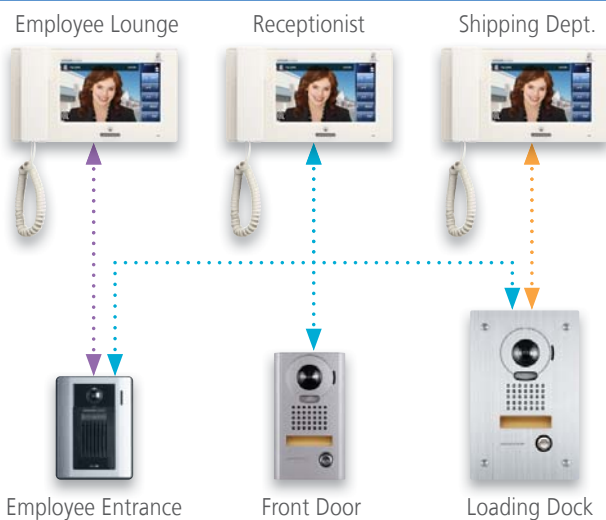

## Door station variety.

Using JK Series door stations, there is a door station to suit any application. Integrated access keypads and HID® readers help maintain building safety while continually providing easy access for staff and regular visitors.

# Flexible Wiring Configurations

The JM Series can accommodate up to 4 Door Stations and 8 Inside Stations in a single system. Flexible wiring configuration fits a variety of application needs. The units are connected using CAT-5e/6 cable, allowing for easy installation into new or retrofit applications.

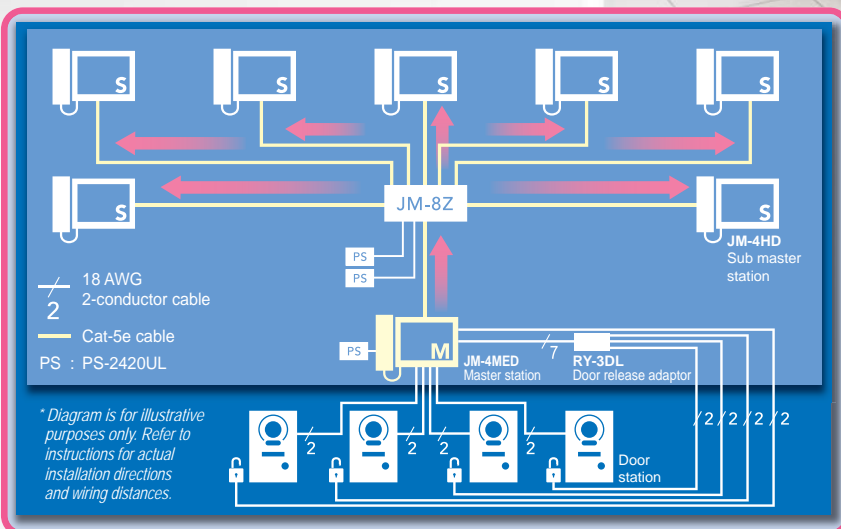
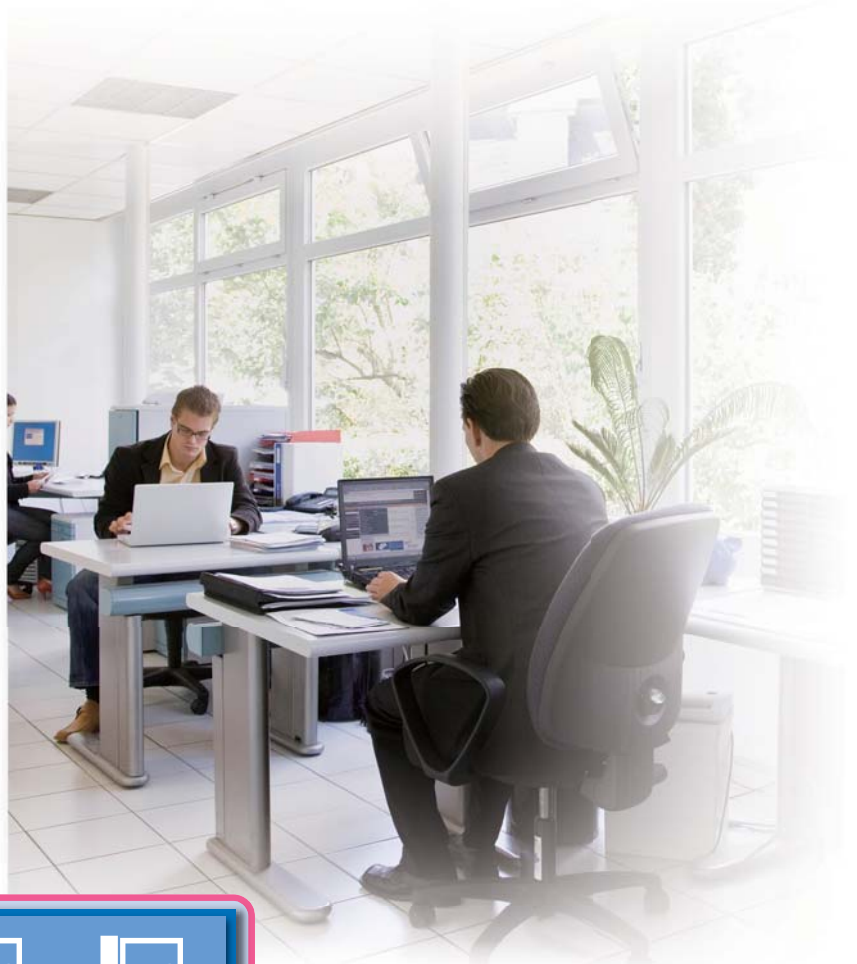
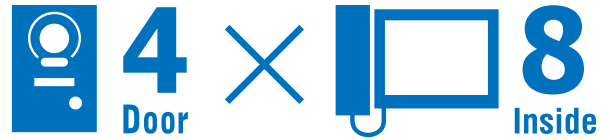

## HOMERUN WIRING (Centralized)

Most buildings today are designed using CAT-5e/6 wire or are being upgraded to accommodate the demands of business professionals. Take advantage of this common wiring method used in other applications such as access control systems or CCTV systems. Connect master stations to a central wiring adaptor to save on installation times.



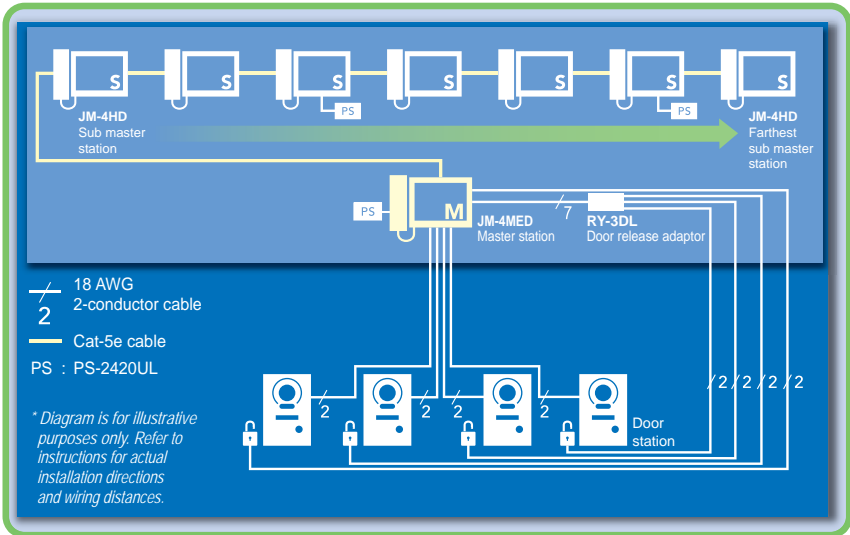

## DAISY-CHAINED WIRING (Station-to-Station)

Directly connect a master station to a sub master station and continue linking stations until the project is completed. This wiring style is also perfect for projects where maximum distance is a concern. Station-to-station wiring was commonly used with older style intercom systems. Now, easily replace or upgrade previously installed systems by using this commonly found wiring technique.

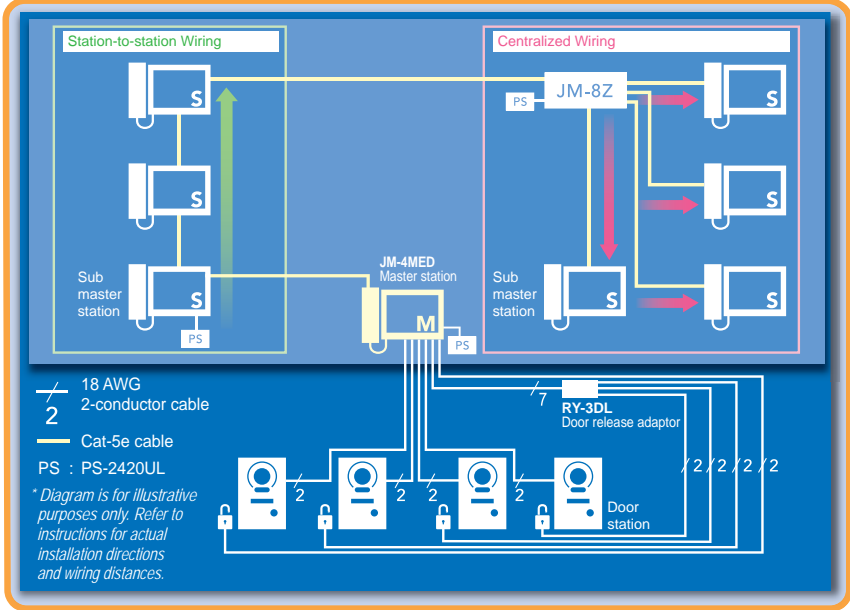

## COMBINED WIRING

The JM Series also can accommodate a blended wiring style to meet the unique requirements of a particular building. Connect a system using both station-to-station and centralized wiring where needed.

## Simple CAT-5e/6 Wiring

Save money!! Install the JM Series using today's most readily available wire. Choose from a variety of wiring methods to accommodate different building requirements.



## Use a CCTV camera with an Audio Door Station

See the surrounding area by connecting a security camera using the JMW-BA adaptor. Connect a GT-D to the JMW-BA for two way communication.

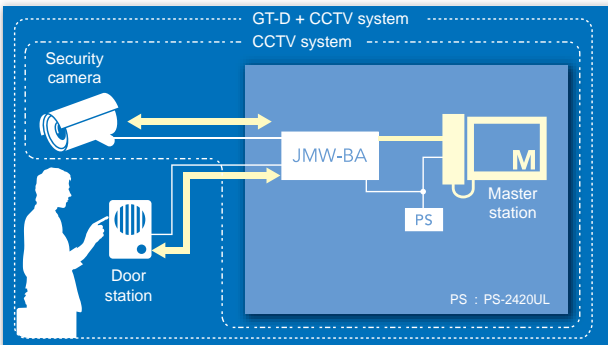
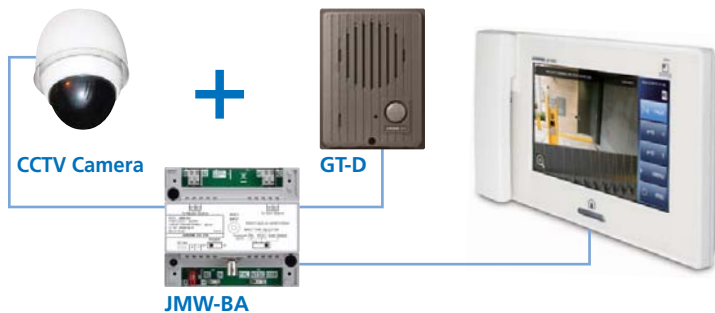

# Additional JM Series Features

Convenience and Security at Your Fingertips

## Three Alarm Inputs

Connect up to 3 sensors to the master station. When a sensor is triggered, all inside stations send out an alarm notification. Sensors can include door/window contacts, water sensors, and Personal Emergency Response System (PERS) devices.

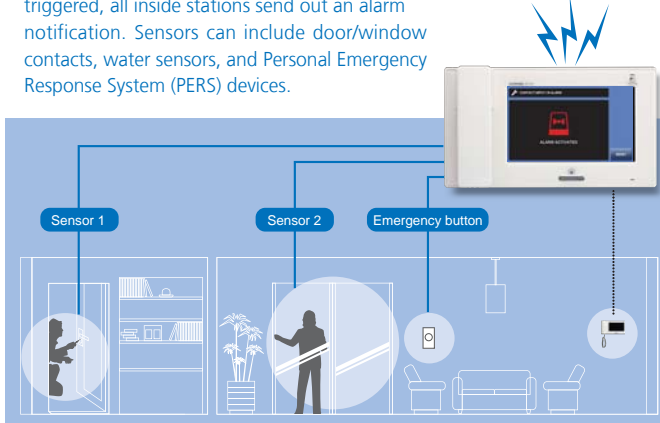

## Call Extension and External Relay

Using the RY-ES, door station call-ins can be heard throughout the building using bell systems. Optionally use a call extension speaker (IER-2) to alert occupants in remote parts of the building that someone is at the door.

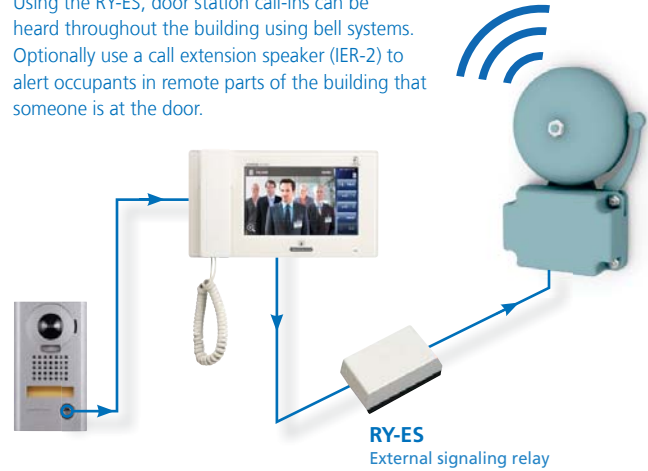

## Video + Audio Monitoring

Inside stations can be set to monitor door stations with video and audio. Inside stations can also audibly monitor other inside stations.



## Multi-Lingual Support

The JM Series interface supports the following 9 languages:



- English
- French
- Spanish
- German
- Dutch
- Italian
- Norwegian
- Chinese (Traditional)
- Chinese (Simplified)

## Secondary Output Control

The JM Series does more than just open doors. An additional output is included to control secondary devices like gates and exterior lights, for added convenience.

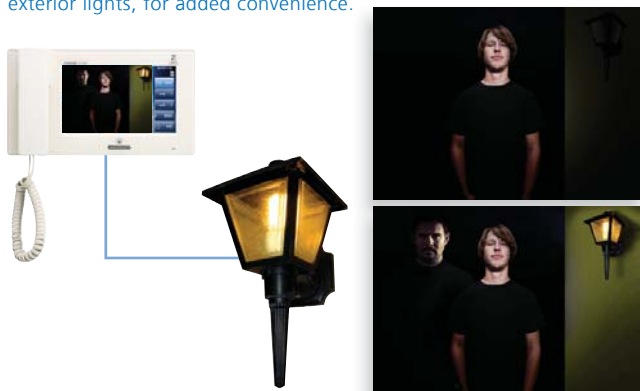

## Video Out

The JM-4MED features a video out via a supplied connector to send video and images to a DVR or to view them on a security video display.

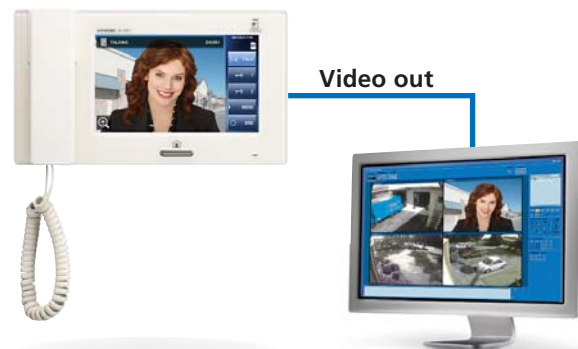

# JM Series Components



## Start with a box set....



Begin by selecting a JM Series Box Set. Additional components below can be installed to expand features and functionality. Each set contains (1) JM-4MED master station, (1) door station, and (1) PS-2420UL power supply. Just add wire!

### JMS-4AED Box Set



Includes:

- Door Station | **JK-DA**: PTZ video door station, plastic, surface mount  
W: 3-7/8" H: 5-1/8" D: 1-1/8"
- Master Station | **JM-4MED**: Touchscreen video intercom master station  
W: 10-1/16" H: 5-11/16" D: 1-7/8"
- Power Supply | **PS-2420UL**: Power supply

### JMS-4AEDV Box Set



Includes:

- Door Station | **JK-DV**: PTZ video door station, zinc die cast, surface mount  
W: 3-7/8" H: 6-13/16" D: 1-1/8"
- Master Station | **JM-4MED**: Touchscreen video intercom master station  
W: 10-1/16" H: 5-11/16" D: 1-7/8"
- Power Supply | **PS-2420UL**: Power supply

### JMS-4AEDF Box Set



Includes:

- Door Station | **JK-DVF**: PTZ video door station, stainless steel, flush mount  
W: 5-5/16" H: 8-1/4" D: 1-7/8"
- Master Station | **JM-4MED**: Touchscreen video intercom master station  
W: 10-1/16" H: 5-11/16" D: 1-7/8"
- Power Supply | **PS-2420UL**: Power supply

## ...and expand by adding these components

### Door Stations

Up to 4 door stations total per system



**JK-DA**  
PTZ video door station,  
plastic, surface mount  
W: 3-7/8" H: 5-1/8" D: 1-1/8"



**JK-DV**  
PTZ video door station,  
zinc die cast, surface mount  
W: 3-7/8" H: 6-13/16" D: 1-1/8"



**JK-DVF**  
PTZ video door station,  
stainless steel, flush mount  
W: 5-5/16" H: 8-1/4" D: 1-7/8"



**GT-D\***  
Audio only door station,  
plastic, surface mount  
W: 3-7/8" H: 5-1/8" D: 1-1/8"



**JK-DVF-HID\***  
PTZ video door station,  
stainless steel, flush mount  
with HID® ProxPoint® Plus  
embedded card reader  
W: 5-3/4" H: 11-5/8" D: 1-3/4"



**JK-DVF-AC\***  
PTZ video door station,  
stainless steel, flush mount  
with access code keypad  
W: 5-3/4" H: 11-5/8" D: 1-3/4"

\*The JM-4MED can be purchased separately when a GT-D, JK-DVF-HID, or JK-DVF-AC is the only door station to be used in a system.

### Sub Master Station

Up to 7 per system (+1 JM-4MED)



**JM-4HD**  
Touchscreen video intercom  
sub master station  
W: 10-1/16" H: 5-11/16" D: 1-7/8"

### Power Supply

Power requirements vary depending on wiring method and number of stations in system. See instructions for details.



**PS-2420UL**  
24V DC, 2A

### Accessories



**JMWB-BA**  
Long distance /  
CCTV adaptor



**JM-8Z**  
Sub master station  
distribution adaptor



**IER-2**  
Call extension  
speaker



**RY-ES**  
External signaling  
relay



**RY-3DL**  
Selective 3 door  
release adaptor



**MCW-S/A**  
Inside station  
desk stand



**AC-10S**  
Access control keypad,  
zinc die cast to match  
JK-DV, surface mount



CONTACT YOUR LOCAL AIPHONE EXPERTS TO SET-UP A  
**FREE PRODUCT DEMO!**



Distributed by:

ISO-14001  
Certified



Aiphone Co. Ltd.

ISO 9001:2008  
Certified



Aiphone Corp.

Deming  
Prize



Aiphone Co. Ltd.

**AIPHONE®**

1700 130th Ave. NE  
Bellevue, WA 98005  
Ph: (800) 692-0200  
Fax: (425) 455-0071

[www.aiphone.com](http://www.aiphone.com)