

# VR120 VANDAL RESISTANT AUDIO AND VIDEO DOOR ENTRY SYSTEMS (136 AMPLIFIER)





# CONTENTS



	PAGE
Manual Introduction	4
System Introduction	4
System Components	5
Door Panels	5 - 7
Additional Panel Components	7 - 9
VR120 Panel Dimensions	9
VR120 Back Box Dimensions	10 - 11
Power Supplies & Control Equipment	12 - 15
Audiophones	16
• 3000 Series Audiophones	16
• 5000 Series Apartment Stations	17 - 19
Videophones	19
• 3600 Series Videophones	19 - 25
• 5000 Series Handsfree Eclipse	25 - 28
Accessories	29
Deskmount Kits	30 - 32
Installation	32
Cable Type and Cable Size Guide	33 - 36
Block Diagrams	36
• Audio System Block Diagram	36
• Video System Block Diagram	37
Panel & Back Box Installation	38
Panel Care	39
Testing the Installation	40
Accessories Connection Guide	41 - 42
Code Lock Programming Guide	43 - 44
Timeclock Programming Guide	45
Wiring Diagrams	46
• Audio System Wiring Diagram	46
• Video System Wiring Diagram	47
Trouble Shooting	48 - 49
Notes	50 - 51

## MANUAL INTRODUCTION

The information in this manual is intended as an installation and commissioning guide for the Videx VR120 range of vandal resistant door panels, to be used with standard electronic call tone telephones or videophones using the Art.520M and Art.893N power supplies. This manual should be read carefully before the installation commences. Any damage caused to the equipment due to faulty installations where the information in this manual has not been followed is not the responsibility of Videx Security Ltd.

VIDEX run free training courses for engineers who have not installed this system before. Technical help is also available on 0191 224 3174 during office hours or via e-mail [tech@videx-security.com](mailto:tech@videx-security.com).



An electronic copy of this technical manual can be downloaded by scanning the QR code to the right.

## SYSTEM INTRODUCTION

The VR120 door panels are all 120mm wide and have CALL PROGRESS LEDs for 'SPEAK', 'DOOR OPEN' and 'BUSY' along with distinct audio reassurance tones to assist the visitor. The panels come with buttons that are IP68 rated with the option of a yellow bezel offering a high contrast to the fascia for DDA requirements. All face plates are deep engraved with 6mm in-filled black characters to identify each button. Optional colours for specific applications can be specified along with custom logos. The VR120 face plates are attached to their back box with either 4 or 6 anti-vandal fixings depending on panel size and options. All face plates are fitted with a purpose manufactured neoprene seal to prevent the ingress of dust and liquid.

All audio amplifiers and microphones are protected with a fine offset stainless steel mesh to protect against vandalism. All speakers have Mylar cones to further protect against the effects of moisture. Full control of volume levels to the amplifier and the telephones can be adjusted independently on the 136 amplifier with two POT controls, one for the speaker and one for the microphone. Also additional features including speech time, lock release time and reassurance volume can be adjusted by the positioning of a series of dip-switches and jumpers.

Flush back boxes are standard. Stainless steel bezel flush boxes and surface with rain shield are also available across the range (see pages 10 and 11).

### Key Features

- 12 Gauge stainless steel.
- IP68 rated buttons with optional yellow bezel.
- SPEAK, BUSY and OPEN call progress LEDs.
- Call progress reassurance tones.
- Dry contact relay output for lock release or gate controller.
- Timed call, speech and lock release.
- Speaker and microphone volume adjustment.

These panels can be used for single entrance or multiple entrance systems. We would suggest using this system on small to medium sized installations of no more than 20 apartments.



# SYSTEM COMPONENTS

A standard audio system will comprise of a door panel, power supply and audio telephones. A standard video system will comprise of a door panel, audio and video power supplies, video splitters and videophones. The individual parts are described below.

## DOOR PANELS

An audio or video vandal resistant door panel will consist of a 136 amplifier module, button connector board and 'n' number of buttons. Additionally call buttons can be engraved to suite the apartment numbers.

### Speaker module connections, switches and jumper

#### Dip-Switches

The four way dip-switch bank has the following functions. Please note: dip-switches must be set before power up. Any changes made when power is on will not take effect until a power down reset.

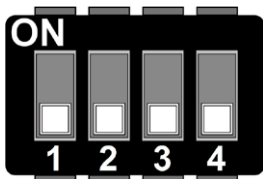

Speech Time	
Switch 1 OFF	1 minute
Switch 1 ON	2 mintues

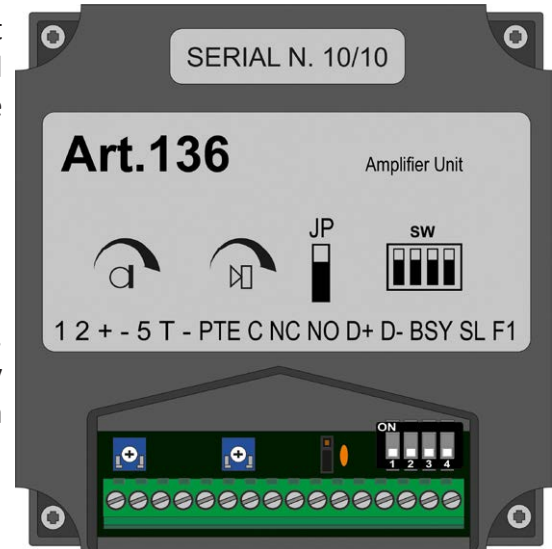

Relay Time			
Switch 2 OFF	2 seconds	Switch 2 ON	8 seconds
Switch 3 OFF		Switch 3 OFF	
Switch 2 OFF	4 seconds	Switch 2 ON	20 seconds
Switch 3 ON		Switch 3 ON	

Speech Live	
Switch 4 OFF	Only when called
Switch 4 ON ( <i>only possible on one door systems</i> )	Speech live whenever handset lifted

#### Jumper

Jumper JP controls the reassurance tone volume level at the door panel.

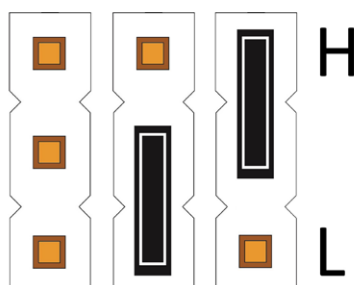

Position H	High volume reassurance tone
Position L	Low volume reassurance tone
No Jumper	No reassurance tone

#### POTS

Speech volume adjustments are carried out at the door panel using a small trimmer driver.



adjustment for speech volume at the apartment (microphone)



adjustment for speech volume level at the door station (speaker)

VX136 Amplifier Module		VX136 Current Rating on +12Vdc	
Connection	Function	Condition	Current (mA)
1	Receive speech from apartment	Standby	18mA
2	Transmit speech to apartment	System busy	58mA
+	+12Vdc input	During a call	122mA
-	0V (Ground)	Live speech	108mA
5	Switched 0V from phone to trigger door release relay	Lock Release	125mA
T	Electronic call tone output to common side of call buttons	Maximum	130mA
-	0V for use with push to exit input (PTE)		
PTE	Switched 0V input from push to exit button to trigger door release relay		
C	Common connection of dry contact relay		
NC	Normally closed connection of dry contact relay		
NO	Normally open connection of dry contact relay		
D+	External link to door open (+12V side) LED. Not used with this kit		
D-	External link to door open (0V side) LED. Not used with this kit		
BSY	Busy signal for use with multiple door systems (Normally high, 12V. Low when busy 0V)		
SL	Switched 0V output to switch on video PSU. (0V throughout a call, open collector in standby)		
F1	Switched 0V output to switch on camera. (0V throughout a call, open collector in standby)		

### Camera module connections

Camera module (Art.VR4KCMC)			
Connection	Function		
SL	Active low input to enable the camera (the jumper JP2 must be in the 'SL' position)		
SB	Heater ground input		
V1	Balanced video signal sync+		
V2	Balanced video signal sync-		
V	Coax video signal	VR4KCMC Current Rating on +12Vdc and +20Vdc	
-	Video ground input	Condition	Current (mA)
SB	+12Vdc heater input	SB (+12Vdc heater)	90mA
+20	+20Vdc power supply input	+20Vdc during call	160mA
+12	+12Vdc power supply input	+12Vdc during call	175mA

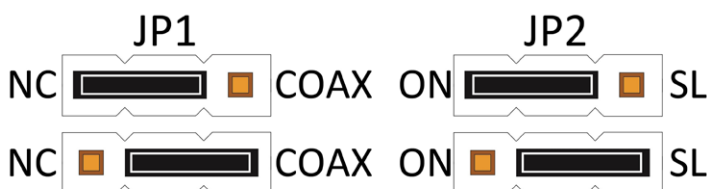

### Camera settings

The JP1 jumper sets the video mode:

- NC = balanced video signal (V1 and V2).
- COAX = coax video signal (V and -).



The JP2 jumper sets the camera switching 'ON' mode:

- ON = the camera switches 'ON' if supplied with either +12Vdc on terminals +12 and – or with +20Vdc on terminals +20 and – power supply inputs.
- SL = the camera switches 'ON' when 0v is applied to the SL terminal (A permanent +12Vdc or +20Vdc is required on either the +12 and – terminals or the +20 and – terminals).

## ADDITIONAL PANEL COMPONENTS

Both audio and video vandal resistant panels can also come with coded access and/or proximity access and an induction loop facility incorporated into the panel.

### CODELOCK (Art.VR4KCLM)

The codelock module can be powered from 12-24V AC or DC and includes two dry contact relay outputs and two switched 0V push to exit button inputs which can be used to trigger relay 1 & 2. 1 code per relay can be programmed into the device. Codes can be 4-8 digits long. Relay time can be 01-99 seconds or latching (00). When in latching mode, enter the code followed by Enter to latch and the code followed by Clear to unlatch.

Code lock module (Art.VR4KCLM)	
Connection	Function
+	12-24V AC or DC power input
-	0V power input
C1	Relay 1 common connection
NO1	Relay 1 normally open connection
NC1	Relay 1 normally closed connection
C2	Relay 2 common connection
NO2	Relay 2 normally open connection
NC2	Relay 2 normally closed connection
SW1	Switched 0V input to trigger relay 1
SW2	Switched 0V input to trigger relay 2
VR4KCLM Current Rating on + input	
Condition	Current (mA)
Standby	18mA
Relay Trigger	35mA
Max	40mA

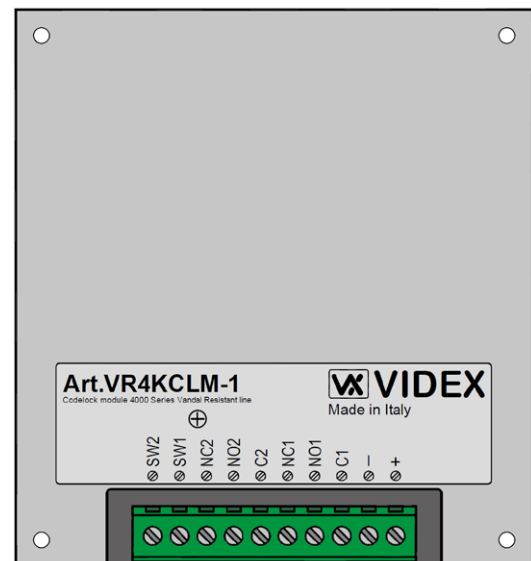

Codelock programming can be found on pages 43 - 44.

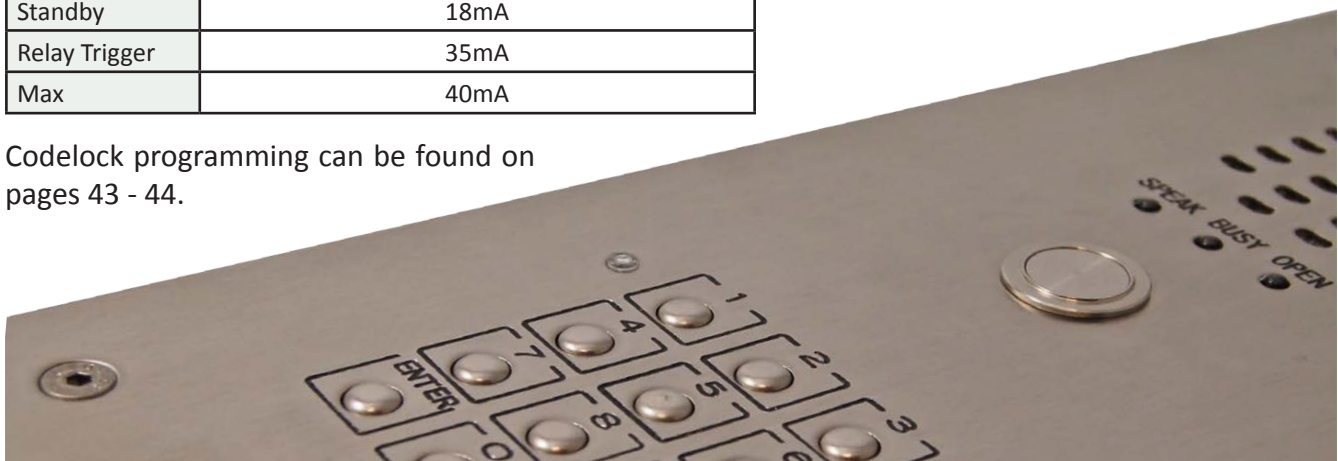

Proximity module (VP/PM)			VP/PM Current Rating on 12V	
Connection	Function	Colour	Condition	Current (mA)
-	0V power connection	Grey	Standby	80mA
12V	12Vdc power input	White	Operation	70mA
RK	Serial data connection to controller	Yellow	Max	85mA
LR	Red LED control line (also controls the internal sounder)	Brown		
LG	Green LED control line (also controls the internal sounder)	Green		

### VPROX PROXIMITY READER (VP/PM)

The VP/PM proximity reader will work with any of the Videx VProx controllers (VP20, VP100, VP250, VP1000 and VP4000). The VP/PM reader requires five connections as shown in the table above. For more information regarding the programming and set up of the proximity system please consult the VProx manual supplied with the controller.



### INDUCTION LOOP

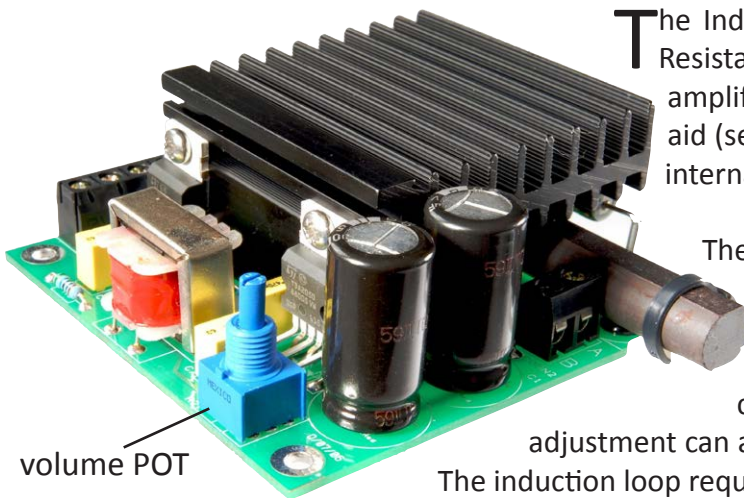

The Induction Loop module can be fitted to Vandal Resistant panels and is connected to the Videx door amplifier module and enables users with a hearing aid (set to the 'T' position) to hear speech from the internal intercom phone.

The unit is already fitted with an internal aerial which eliminates the need for an external aerial to be connected. It can be powered by 12V/24V AC or DC power with a resting current of approximately 50mA. A volume adjustment can also be made using the on-board volume POT.

The induction loop requires its own 12Vdc 3A power supply the SP28.

Induction Loop (VRIND)		Current Rating	
Connection	Function	Condition	Current (A/mA)
1	+12V/24V dc positive power	Standby	40 - 50mA
2	+12V/24V ac power	Live speech (AC)	2.5 - 2.8A
3	+12V/24V ac power	Live Speech (DC)	2.5 - 2.8A
4	GND dc power	MAX	3A
5	0V reference (earth if required)		
6	Spare (unused)		
7	Terminal 1 connection on intercom phone		
8	Terminal 1 connection on door amplifier		
9	Voltage signal input (unused)		
A	External aerial feed	(If A/B connections are being used then internal aerial must be disconnected)	
B	External aerial feed		

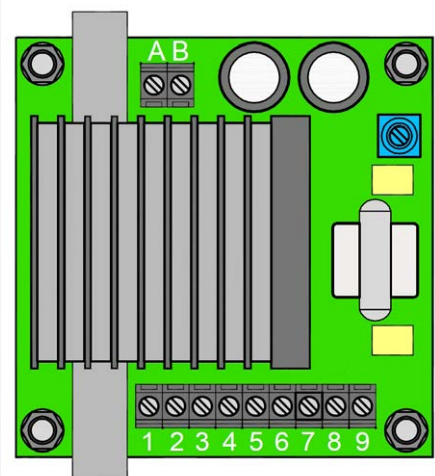



## INDUCTION LOOP POWER SUPPLY (SP28)

The SP28 power supply is a 13.8Vdc regulated power supply with a current rating of 3A. It features a battery back up facility as standard and can be used with a 7Ah sealed lead acid battery.



Current (A)	Mains Fuse	DC Out Fuse	Battery Trickle Charge Fuse
3A	T630mA	F3.0A	T315mA

## VR120 PANEL DIMENSIONS

Panel sizes (Part No. VR120/136-n where n = number of buttons)



Type →	Audio	Video	Audio +	Video +	Audio +	Video +
Buttons ↓			Prox	Prox	CodeLock	CodeLock
1	120x220	120x280	120x280	120x400	120x280	120x400
2	120x220	120x280	120x280	120x400	120x280	120x400
3	120x220	120x280	120x280	120x400	120x280	120x400
4	120x220	120x400	120x280	120x400	120x400	120x500
5	120x220	120x400	120x280	120x400	120x400	120x500
6	120x220	120x400	120x280	120x400	120x400	120x500
7	120x280	120x400	120x400	120x500	120x400	120x500
8	120x280	120x400	120x400	120x500	120x400	120x500
9	120x280	120x400	120x400	120x500	120x400	120x500
10	120x280	120x400	120x400	120x500	120x400	120x500
11	120x280	120x400	120x400	120x500	120x400	120x500
12	120x280	120x400	120x400	120x500	120x400	120x500

### Examples

A = 6 way audio

B = 3 way audio and video

C = 12 way audio with induction loop

D = 12 way audio and video with code lock

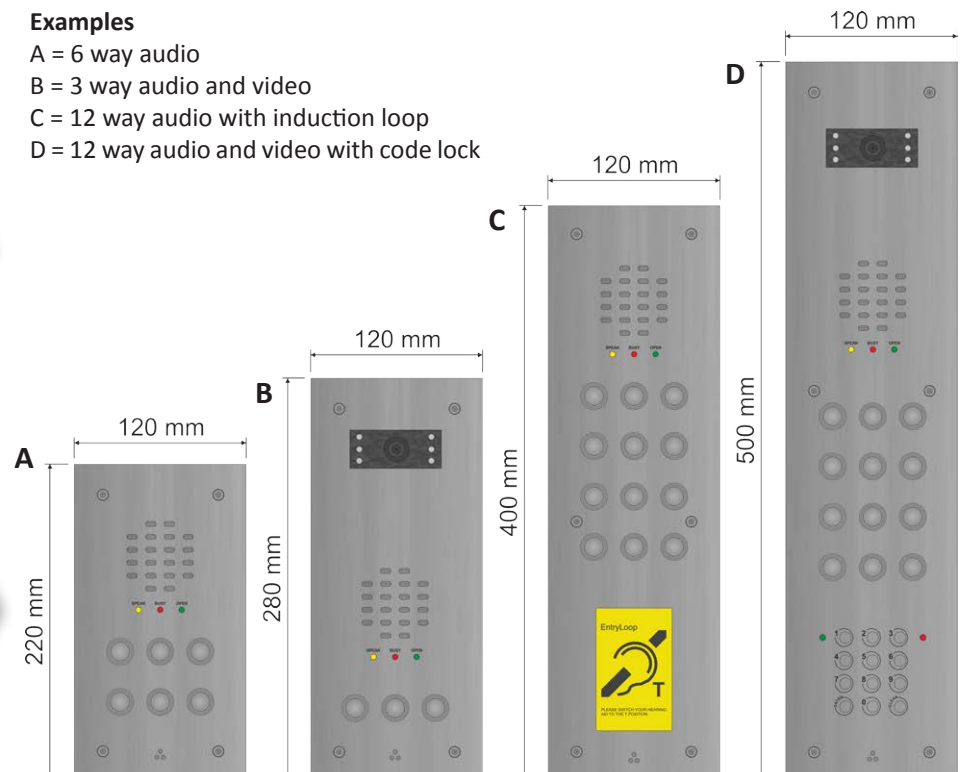

# VR120 BACK BOX DIMENSIONS

There are three VR120 panel back box options available, a standard flush back box, a flush back box with bezel and a surface back box with rainshield.

## Back Box Sizes

Panel Size →	120x220	120x280	120x400	120x500
Box ↓				
Flush	100x200x50 (VRFB120x220)	100x260x50 (VRFB120x280)	100x380x50 (VRFB120x400)	100x480x50 (VRFB120x500)
Flush Bezel	Box: 157x257 Bezel: 123x223x60 (VRBB120x220)	Box: 157x317 Bezel: 123x283x60 (VRBB120x280)	Box: 157x437 Bezel: 123x403x60 (VRBB120x400)	Box: 157x537 Bezel: 123x503x60 (VRBB120x500)
Surface	124x224x80 (VRSB120x220)	124x284x80 (VRSB120x280)	124x404x80 (VRSB120x400)	124x504x80 (VRSB120x500)

## FLUSH BACK BOX

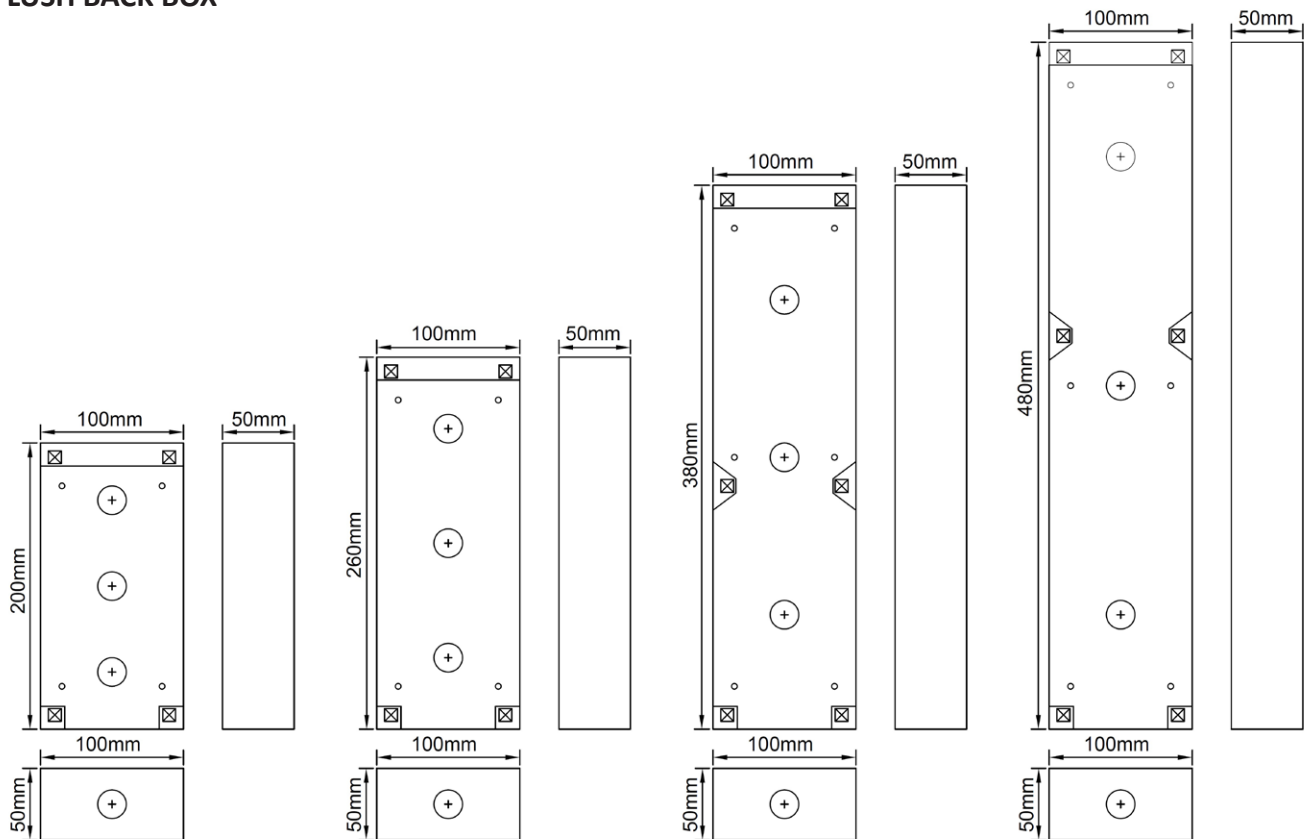

## FLUSH BEZEL BACK BOX

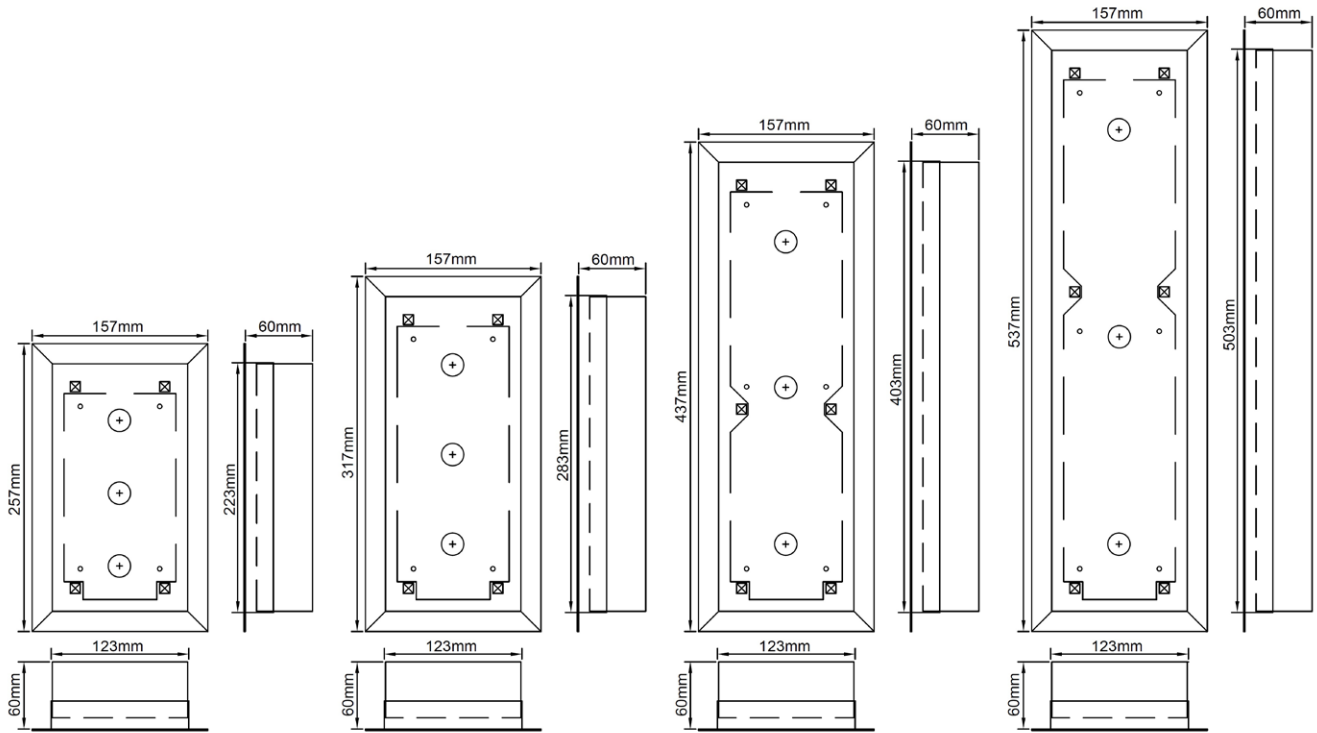

## SURFACE BACK BOX (RAINSHIELD)

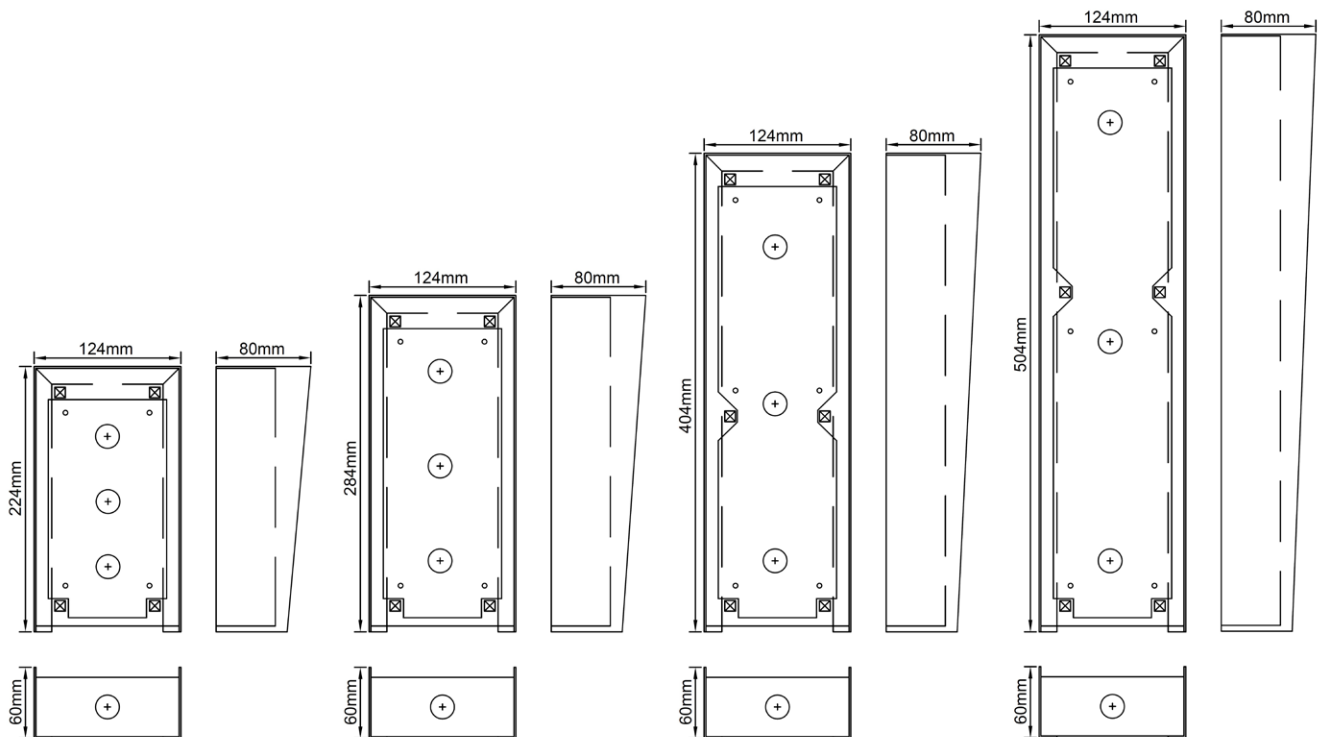

# POWER SUPPLIES AND CONTROL EQUIPMENT

## Audio and Video System Power Supplies

### Art.520M and Art.520MR

The standard power supply is the Art.520M. Outputs of 12Vdc (200mA max), 8Vdc (300mA max) and 13Vac (1A max) are available. The dc outputs are designed to power the amplifier modules only and cannot be used to power other devices such as code locks, lock releases etc. These items must be connected to the AC output of this power supply. The Art.520MR is the same as the Art.520M but also includes a built in dual pole relay which is controlled by the inputs M, B and A and is used on multiple entrance video systems to switch the video signal between entrances.

Terminal	Function
+12	12Vdc output (200mA max.)
+	8Vdc output (300mA max.)
-	0V (Ground)
~	13Vac (1A max.)
M	Relay control - GND
B	Relay control - +20V signal
A	Relay control - +12V signal
NC2	Normally closed 2 contacts
C2	Common 2 contacts
NO2	Normally open 2 contacts
NC1	Normally closed 1 contacts
C1	Common 1 contacts
NO1	Normally open 1 contacts
230V~	Mains in (Live connection)
0V	Mains in (Neutral connection)

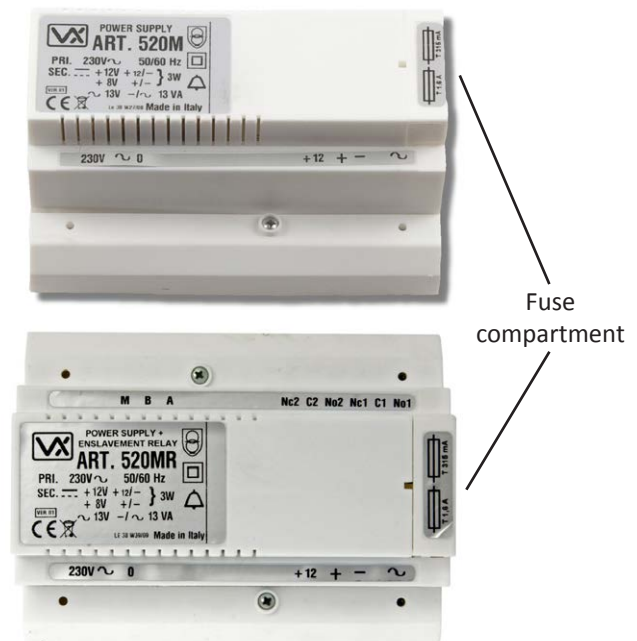

### Art.521B

The standard power supply with battery back-up facility is the Art.521B. Outputs of 13.8Vdc (1A max) and 13Vac (1.6A max) are available. It also includes a battery back-up set of terminals to connect a 12v DC battery (typically the NP7-12 battery). The 13.8Vdc output is designed to power the amplifier modules and can also be used to power other devices such as code locks, DC lock releases etc. The 13Vac output can be used to power AC lock releases.



Terminal	Function
+	13.8Vdc output (1A max. 800mA continuous)
-	0V (Ground)
SW	13.8Vdc output ON/OFF switch (closed to enable output)
SW	
13V~	13Vac output (1.6A max.)
13V~	
-	0V battery (Ground)
+B	+12v battery (100mA battery recharge input)
230V~	Mains in (Live connection)
0V	Mains in (Neutral connection)

## Video System Power Supply

### Art.893N1

The Art.893N1 power supply is a +20Vdc (800mA continuous 1A surge max.) PSU and is used to power videophones and camera modules or as a booster supply when more than two videophones are required in an apartment. This power supply only has an output when either a -negative trigger is applied to -C or when a +positive trigger voltage is applied to +C. At all other times the + and D+ outputs are switched off. The D+ output is a +20Vdc output that is protected by a diode.

Terminal	Function
D+	Switched +20Vdc output via diode (triggered by -C or +C, 1A max. 800mA continuous)
+	Switched +20V dc output (triggered by -C or +C, 1A max. 800mA continuous)
-	0V (Ground)
-C	-negative trigger input (from 0V to +4V)
+C	+positive trigger input (from +8V up to +30V)
230V~	Mains in (Live connection)
0V	Mains in (Neutral connection)



## Timeclock

### Art.701T (28G)

The Art.701T timeclock is a digital timeclock with BST/GMT automatic correction, back lit LCD display and trade button input. This time clock operates from a 12Vac or dc power supply. The output is a dry contact relay. It is primarily used with this system when a trade facility (button) is required. This allows the dry contact relay to drive the lock release directly. The relay can be programmed to release the lock for 1 – 99 seconds. The timeclock has the following key features:

### Key Features

- 12Vac or dc power input.
- Dry contact 3A rated relay output (CO, NO and NC).
- Six fully programmable ON/OFF times (the time periods can be set for a single day of the week, weekends, week days or all days. To disable simply set the ON time the same as the OFF time).
- Three month rechargeable on board battery backup that will maintain the correct time and all time bands during mains failures. The battery backup facility can be disabled, by moving JP3 into position B.
- Automatic British summer time correction (BST/GMT). If this feature is not required it can be disabled, by moving JP2 into position A.
- Manual override button to toggle the relay on and off in standby mode.  
(NOTE: If manually toggled to OFF during an ON or OFF time it will not switch back ON automatically until the next ON time and if manually toggled to ON during an ON or OFF time will not switch back to OFF until the next ON then OFF time expires. Going though the programming menu or switching off then on will restore the ON/OFF state to the time band settings).
- Trade button input: When the time clock is used in trade mode, the relay will only energise when the trade button is pressed and then, only during an active time band. The time clock can be switched into trade mode by moving JP1 into position A. When JP1 is in position B the relay will energise for the full duration of an active time band.



- Trade activated relay time can be adjusted from 1 second up to 99 seconds during programming.
- All information is displayed on an easy to read 2 lines 16 characters back lit LCD display.
- The time clock is mounted within an ABS white wall mountable plastic box.

Terminal	Function	Current Rating on + input	
		Condition	Current (mA)
+	12Vac or dc voltage input		
-	0V (Ground)	Standby	47mA
-	0V trade button connection	During Operation	67mA
TR	Trade button input (Switched 0V)	Max	70mA
CO	Common connection on relay	Max. current and voltage for relay 3A @ 24Vdc and 3A @ 120Vac	
NO	Normally open connection on relay		
NC	Normally closed connection on relay		

### Jumper Settings

The Art.701T timeclock mode and settings can be adjusted by a series of three jumpers JP1, JP2 and JP3.

- JP1 sets up the mode of operation, trade button mode or timeclock mode.
- JP2 sets up the BST/GMT time correction mode.
- JP3 sets up the battery back up facility (switched ON or OFF).

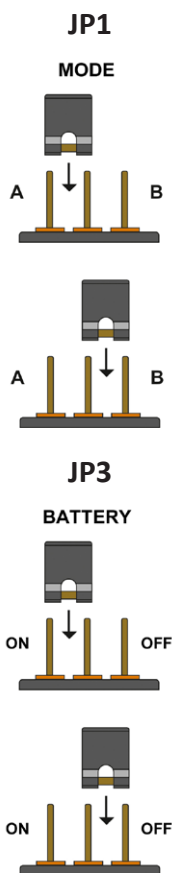

JP1 in position A = Trade button mode  
JP1 in position B = Timeclock mode

JP2 in position A = Automatic BST/GMT time correction disabled  
JP2 in position B = Automatic BST/GMT time correction enabled

JP3 in position A = Battery back up enabled  
JP3 in position B = Battery back up disabled

The Art.701T timeclock programming can be found on page 45.

## Video Distribution Boxes

There are two types of video distribution boxes available, the Art.316 and the Art.894, depending on the type of video signal required (balanced video or coax video).

### The Art.316

The Art.316 is a non-coax (balanced video) 4 way video distribution box. It has 4 video outputs and therefore can feed up to 4 non-coax video monitors. It also incorporates a 'loop through' video connection so that more than one Art.316 can be used in series. When connected in series the last Art.316 in line must be fitted with 2x75 Ohm 'end of line' resistors. Each resistor must be fitted across terminals –(neg)/V1 and across terminals –(neg)/V2 on the output 'loop through' connection.

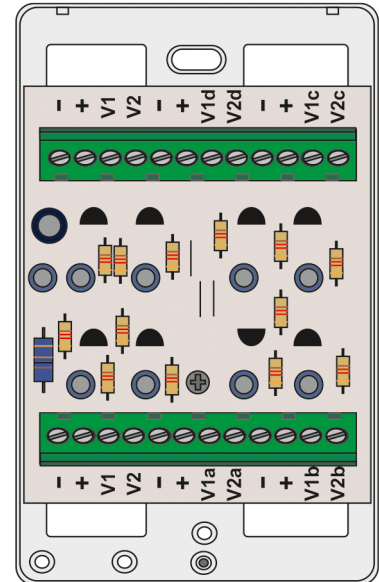

Terminal	Function		
V1	+sync balanced video IN/OUT		
V2	-sync balanced video IN/OUT	<b>Current Rating on +20Vdc</b>	
V1a, V1b, V1c, V1d	+sync balanced video output to videophone (4 outputs)	<b>Condition</b>	<b>Current (mA)</b>
V2a, V2b, V2c, V2d	-sync balanced video output to videophone (4 outputs)	Standby (switched +20Vdc)	0mA
+ (+20Vdc)	+20Vdc feed through to videophones and from psu	During Operation	40mA (per monitor)
-(GND)	0V feed through to videophones and from psu	Max	160mA
If permanently powered by +20Vdc then current rating on +20Vdc 170mA			

### The Art.894

The Art.894 is a 4 way coax video distribution box. It has 4 video outputs and therefore can feed up to 4 coax videophones. It also incorporates a coax video connection IN and OUT so that more than one Art.894 can be used in series. Any spare output, including the main coax feed out, must be fitted with a 75 Ohm resistor. The Art.894 requires +12Vdc power and is fed from the videophone.

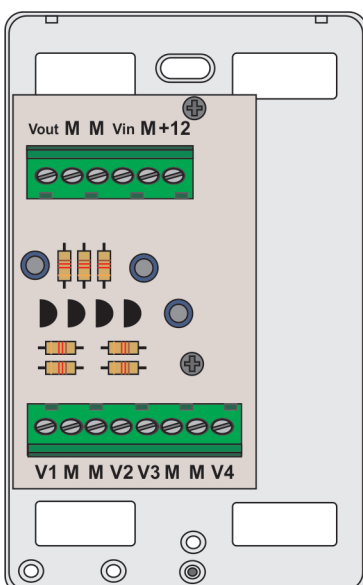

Terminal	Function		
Vin	Video signal (centre core) input	<b>Current Rating on +12 input</b>	
M	Coax screen (GND)	<b>Condition</b>	<b>Current (mA)</b>
VOut	Video signal output to next Art.894 or end of line termination	Standby	0
V1, V2, V3, V4	Video signal output (centre core) to four videophones	During Operation	105mA
+12	+12Vdc power input (from videophones)	Max	110mA
If permanently powered by +12Vdc connect +12 (positive) and M (ground) into a 12Vdc psu. Current rating 105mA			

# AUDIOPHONES

## Audiophones & Apartment Stations

### 3000 Series Audiophones

#### Art.3011

The Art.3011 audiophone is a smart line electronic call tone phone and includes a lock release push button and a 3 level call tone volume switch and requires a minimum of 5 cores for connection.

Terminal	Function
1	Transmit speech to the door panel
2	Receive speech from the door panel
3	0V (Ground)
4	Electronic call tone input
5	Lock trigger (Switched 0V)
6	Not used

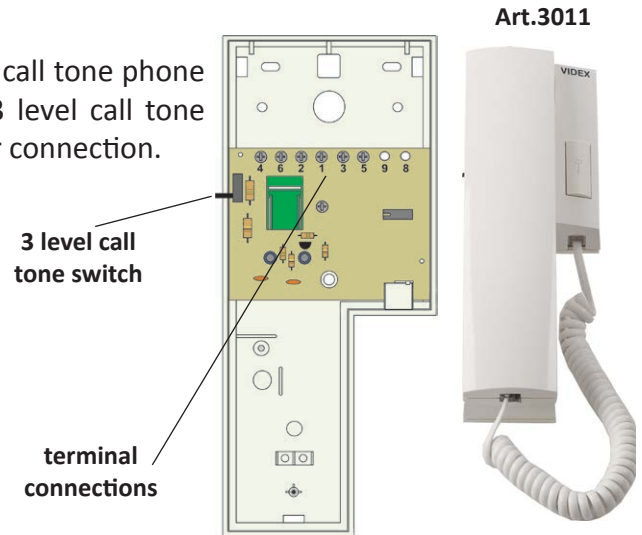

#### Art.3111

The Art.3111 electronic call tone phone includes a lock release push button and spare dry contact push to make button for other services. It also includes a 3 level call tone volume switch and requires a minimum of 5 cores for connection.

#### Art.3112

The Art.3112 electronic call tone phone includes a lock release push button and a spare dry contact push to make button for other services. Additionally it includes a slide mute switch to turn the phone off when the tenant does not want to be disturbed. It also includes a 3 level call tone volume switch. Like the Art.3011 and Art.3111 it requires a minimum of 5 cores for connection.

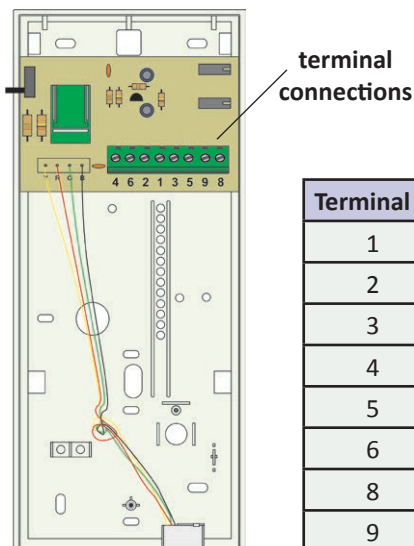
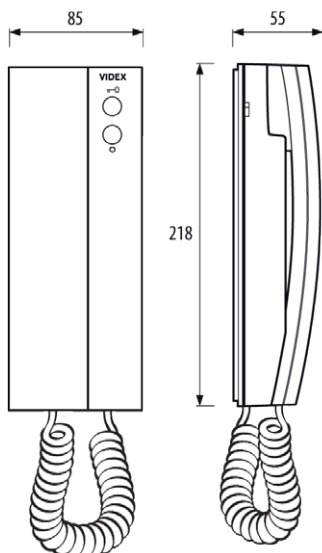

Terminal	Function
1	Transmit speech to the door panel
2	Receive speech from the door panel
3	0V (Ground)
4	Electronic call tone input
5	Lock trigger (Switched 0V)
6	Not used
8	Dry contact switch
9	(for Art.3111 and Art.3112 only)



## 5000 Series Apartment Stations



The Art.5112 audio apartment station includes a talk button and lock release button, two spare push buttons, a three way privacy ON/OFF switch and a call tone volume switch. It requires a minimum of 6 cores for connection and is available in three different finishes, white, silver (/CR) and carbon fibre (/CA).

**Art.5112**

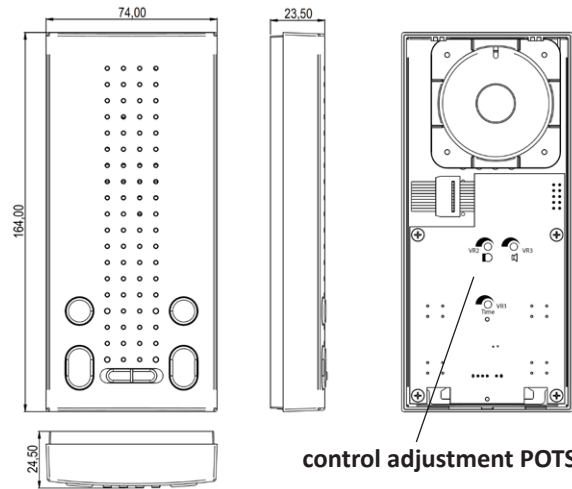

The Art.5112 also has 3 control adjustment POTS:



### Conversation Time (VR1)

This POT adjusts the conversation time duration from a minimum of 2 seconds to a maximum of 45 seconds (rotate left to increase or right to decrease). This time resets each time the speak button is pressed.

### Microphone Volume (VR2)

This POT adjusts the microphone speech volume from the apartment station towards the door intercom panel (rotate left to increase or right to decrease).



### Loudspeaker Volume (VR3)

This POT adjusts the loudspeaker speech volume from the intercom door panel towards the apartment station (rotate left to increase or right to decrease).

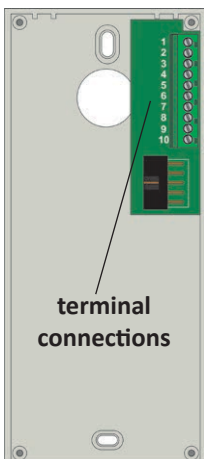

Terminal	Signal	Function	Current Rating on +12V	
			Condition	Current (mA)
1	2A	Receive speech from the door panel	Standby	0
2	4A	Electronic call tone input	During a call	0
3	+12V	+12V DC power supply input	Privacy ON	13.5mA
4	GND	Ground	Live speech	55mA
5	1A	Transmit speech to the door panel	Lock release	48mA
6	● ●	Spare push button two (Switched 0V)	Max	60mA
7	5A	Lock Trigger (Switched 0V)		
8	●	Spare push button one (Switched 0V)		
9	+DOL	Door open LED +positive power supply input		
10	-DOL	Door open LED -negative power supply input		

## Art.5118

Art.5118/CA

The Art.5118 audio apartment station includes a talk button and lock release button, one spare push button, a privacy ON/OFF button. It also has a two button speech line volume adjustment and a two button melody volume adjustment. It requires a minimum of 6 cores for connection and is available in three different finishes, white, silver (/CR) and carbon fibre (/CA).

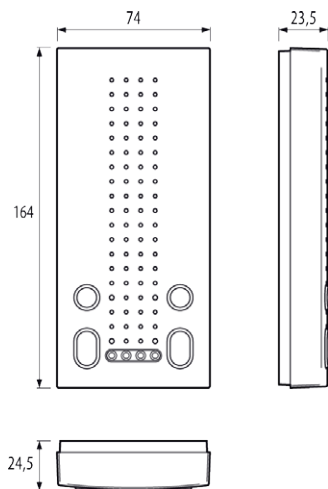

### Speech and Melody Volume control



Speech line volume control. This can be adjusted during a conversation when the speech is live. Pressing the right button to increase or the left button to decrease the volume.

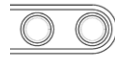

Melody volume control. This can be adjusted when the system is in standby. Pressing the right button to increase or the left button to decrease the melody volume.



Art.5118





Art.5118/CR

## Art.5118 Programming





### Programming the Melody (*factory preset melody 1*)

- Press and hold the two melody buttons (for approximately 10 seconds) until the unit plays the melody currently stored and emits a beep.
- Press the melody button again (left or right) to listen to the available melodies (maximum of 9).
- When the chosen melody has been reached, do not press any other buttons, wait for approximately 3 seconds until the unit emits a beep.
- The new melody will be stored.



### Programming the number of rings (*factory preset = 6 rings*)

- Press and hold the  talk button (for approximately 10 seconds) until the unit emits a beep.
- Press the  talk button again for as many times as the number of rings required, i.e. pressing the button 6 times = 6 rings (maximum of 9 rings).
- Once the number of rings has been reached, do not press any other buttons, wait for approximately 3 seconds until the unit emits a beep.
- The new number of rings will be stored.

### Programming the privacy duration time (*factory preset = no time out, manual control*)

- Press and hold the  privacy button (for approximately 10 seconds) until the unit emits a beep.
- Press the  privacy button again to set the privacy time required. Each time the button is pressed it will increase the privacy duration time by 15 minutes (starting from 0 up to a maximum of 20 hours, i.e. pressing the  privacy button 8 times = 2 hours up to a maximum of 80 presses for 20 hours).
- Once the required privacy duration time has been reached, do not press any other buttons, wait for approximately 3 seconds until the unit emits a beep.
- The new privacy duration time will be stored.
- To set the privacy with no time out, i.e. manual control, press and hold the  privacy button (for approximately 10 seconds) until the unit emits a beep, do not press any other buttons, wait for approximately 3 seconds until the unit emits a beep again.
- The new privacy duration time will be stored.



### Programming the door open time (factory preset = 1 second)

- Press and hold the  lock button (for approximately 10 seconds) until the unit emits a beep.
- Press the  lock button again to set the door open time. Each time the button is pressed it will increase the door open time by 1 second (starting from 1 up to a maximum of 255 second, i.e. pressing the  lock button 10 times = 10 seconds to a maximum of 255 for 4 minutes and 15 seconds).
- Once the required door open time has been reached, do not press any other buttons, wait for approximately 3 seconds until the unit emits a beep.
- The new door open time will be stored\*.

*\*(NOTE: when used with the VR120 panel the door open time should remain set to 1 second as the VR120 panel will control the door open time by setting the dip-switches on the amplifier, refer to page 5)*

### Restoring all programming to factory preset

Please note that this operation will restore all programming back to factory default settings.

- Unplug the Art.5118 from the mounting pcb.
- Press and hold down the  talk button as the Art.5118 is plugged back into the mounting pcb.
- The LED close to the talk button will flash once to confirm all settings have been reset back to factory default.
- Release the  talk button.

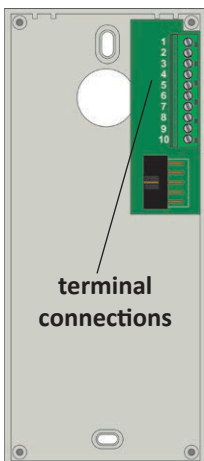

Terminal	Signal	Function	Current Rating on +12V	
			Condition	Current (mA)
1	2A	Receive speech from the door panel		
2	4A	Electronic call tone input	Standby	6mA
3	+12V	+12V DC power supply input	During a call	18-78mA
4	GND	Ground	Privacy ON	10mA
5	1A	Transmit speech to the door panel	Live speech	26mA
6	LB	Local bell facility	Lock release	30mA
7	5A	Lock Trigger (Switched 0V)	Max	80mA
8	●	Spare push button one (Switched 0V)		
9	+DOL	Door open LED +positive power supply input		
10	-DOL	Door open LED -negative power supply input		

## VIDEOPHONES

### Videophones & Handsfree Eclipse

#### 3600 Series Videophones

##### Art.3612

The Art.3612 colour videophone incorporates a colour 3.5" LCD display and includes a lock release push button, camera recall button and a spare push button for other services or depending on setting can act as a secondary camera recall button on a two entrance video system. Coax and non-coax (balanced) video can be used by setting the relevant dip-switches on the rear of the monitor. An Art.5980 back plate is required with this videophone.

##### Controls

- 3 level call tone volume (privacy position plus 2 levels).
- Picture brightness adjustment.
- Picture hue adjustment.



Art.3612

### Minimum Cable Requirement:

- 9 cores + coax for video systems using coax video signal.
- 11 cores for video systems using balanced video signal.

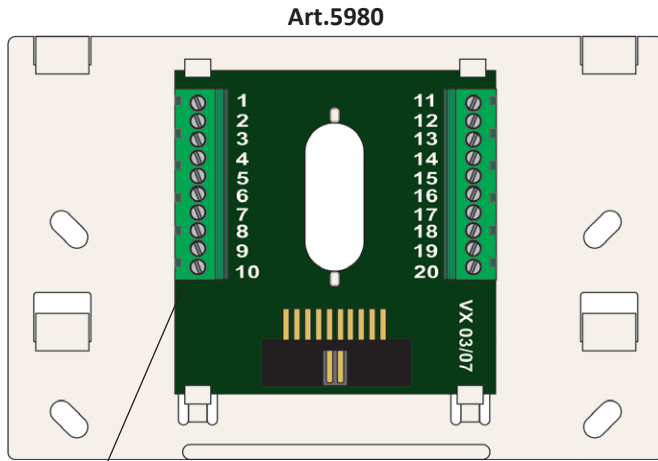

terminal connections

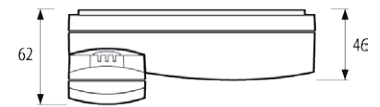
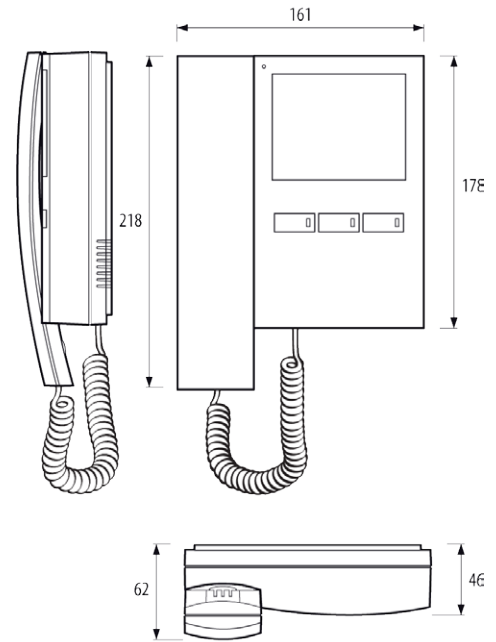

call tone & privacy switch







handset connection

brightness & hue adjustments

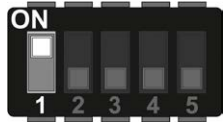
### Connections

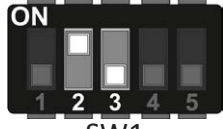
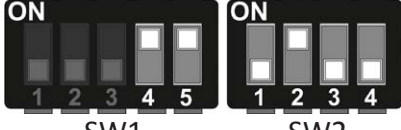
Terminal	Signal	Function	Current Rating on +20V	
			Condition	Current (mA)
1	+12V	+12V out to power video splitter		
2	TV1	Camera recall ●	Standby	0mA
3	TV2	Spare button ● ● (see dip-switch settings)	During call	155mA
4	1	+20V power input	Live speech	155mA
5	2	Door release command (Switched 0V)	Lock release	160mA
6	3	Transmit speech to door panel	Max	200mA
7	4	Receive speech from door panel		
8	5	Speech ground		
9	6	Video power ground		
10	7	Local call tone input (electronic call tone)		
11	V/V1	Coax centre core / V1 balanced video -negative sync		
12	M/V2	Coax Screen / V2 balanced video +positive sync		
13	R	Speech common for intercommunicating systems		
14	C	Call tone input (electronic call tone)		
15	-	Speech ground for intercommunicating systems		
16	T	Service push button common		
17		Unused connection		
18		Unused connection		
19	12Vi	+12Vdc power supply input to switch on the ● ● button LED when the volume switch is in the privacy position		
20	DOL	+12Vdc power supply input to switch on the key button LED		

## Dip-Switch Settings

Function / Description	Dip-Switch Position	Dip-Switch Number
During a call the videophone rings and switches ON showing the video from the door panel.		SW1 - 1 = ON
During a call the videophone rings. Picking up the handset to answer, the monitor will switch ON showing the video from the door panel.		SW1 - 1 = OFF
The ●● button operates as a service button. When pressed terminals 3 and 16 will act as a volt free pair.		SW1 - 2 = OFF, 3 = ON
The ●● button operates as a camera recall button. This can be used for systems with more than one door panel.		SW1 - 2 = ON, 3 = OFF
Composite video signal (coax cable) with termination activated.		SW1 - 4=ON, 5=ON SW2 - 1=OFF, 2=ON, 3=OFF, 4=OFF
Composite video signal (coax cable) with termination disabled. This is used when there is more than one monitor in line and no Art.894 video distribution box is being used.		SW1 - 4=ON, 5=ON SW2 - 1=OFF, 2=OFF, 3=OFF, 4=OFF
Balanced video signal (twisted pair cable) with termination activated.		SW1 - 4=OFF, 5=OFF SW2 - 1=ON, 2=ON, 3=ON, 4=ON
Balanced video signal (twisted pair cable) with termination disabled. This is used when there is more than one monitor in line and no Art.316 video distribution box is being used.		SW1 - 4=OFF, 5=OFF SW2 - 1=OFF, 2=OFF, 3=ON, 4=ON

### Art.3612 Dip-Switches SW1 and SW2



### Art.3618

The Art.3618 colour videophone includes a talk button, a lock release push button, camera recall button and a privacy ON/OFF switch that also doubles up as the OSD menu select button. The OSD menu can be used to adjust the privacy duration time, melody volume, melody type, the number of rings, the door open time, the speech time and brightness and contrast settings. Coax and non-coax (balanced) video can be used by setting the relevant dip-switches. An Art.5980 back plate is required with this videophone.



Art.3618

### Controls and Programming

The adjustments and settings are carried out through two OSD menus. For the video mode (coax or balanced) refer to dip-switch settings (see below).

The videophone has two different menus for programming and adjustment settings:



**Menu 1 operates when the videophone is in standby and allows the following to be set:**













- The Privacy duration
- The melody volume
- The melody type
- The number of rings
- The door opening time

**Menu 2 operates when the videophone is switched ON (during a conversation when speech is live to the videophone or after a camera recall) and allows the following to be set:**









- The Speech volume
- Brightness settings
- Contrast settings
- Hue settings

### Menu 1





- When the system is in standby (*the videophone is switched OFF*) press and hold the  button until the videophone switches ON and emits a beep to enter the programming menu.
- The OSD menu appears on the display: the top of the screen shows 'menu' followed by the available function icons, the bottom of the screen shows the current selected function value on the left, the current selected function icon in the middle and the next function icon on the right side.
- The first function available is the privacy duration (*max 20 hours*). Pressing the  button several times or pressing and holding the button down will increase the privacy duration time. Pressing the  button will decrease the privacy time. The privacy duration will increase or decrease by a half an hour step. The videophone will emit a beep every time the step has been increased or decreased.

- Press the  button to store the new value and to enter the following programming function.
- The second function is the melody volume. Pressing the  button several times will increase the melody volume. Pressing the  button will decrease the melody volume level. The videophone will emit a beep every time the volume level has been increased or decreased.
- Press the  button to store the new value and to enter the following programming function.
- The third function is the melody type. Press the  button to hear and select the previous melody or press the  button to select the next melody.
- Press the  button to store the new value and to enter the following programming function.
- The fourth programming function is the number of rings (*max 9*). Pressing the  button several times or pressing and holding the button down will increase the number of rings. Pressing the  button will decrease the number of rings.
- Press the  button to store the new value and to enter the following programming function.
- The fifth programming function is the door opening time (*max 99 seconds*). Pressing the  button several times or pressing and holding the button down will increase the door release time. Pressing the  button will decrease the door release time.
- Press the  button to store the new value and exit programming menu 1, the videophone will switch OFF.

## Menu 2

- When the videophone is switched ON (*during a conversation or from a camera recall*) pressing the  button will enter the adjustment menu.
- The OSD menu appears on the display: the top of the screen shows 'menu' followed by the available function icons, the bottom of the screen shows the current selected function value on the left, the current selected function icon in the middle and the next function icon on the right side.
- The first adjustment is the speech volume. Pressing the  button several times or pressing and holding the button down will increase the speech volume. Pressing the  button will decrease the speech volume. The videophone will emit a beep every time the volume level has been increased or decreased.
- Press the  button to store the new value and to enter the following programming function.
- The second adjustment is the brightness. Pressing the  button several times or pressing and holding the button down will increase the brightness level. Pressing the  button will decrease the brightness level. The videophone will emit a beep every time the brightness level has been increased or decreased.
- Press the  button to store the new value and to enter the following programming function.
- The third adjustment is the contrast. Pressing the  button several times or pressing and holding

the button down will increase the contrast level. Pressing the  button will decrease the contrast level. The videophone will emit a beep every time the contrast level has been increased or decreased.

- Press the  button to store the new value and to enter the following programming function.
- The fourth and last adjustment is the hue. Pressing the  button several times or pressing and holding the button down will increase the hue level. Pressing the  button will decrease the hue level. The videophone will emit a beep every time the hue level has been increased or decreased.
- Press the  button to store the new value and exit programming menu 2, the videophone will switch back to the standard messages window for conversation.

### Connections

Terminal	Signal	Function	Current Rating on +12V and +20V	
			Condition	Current (mA)
1	+20V	+20Vdc power input		
2	+20V	+20Vdc power input	Standby (+20V)	0mA
3	GND	Ground	During call (+20V)	250mA
4	GND	Ground / Coax screen	Standby (+12V)	18 - 20mA
5	V2/V	Coax centre core / V2 balanced video +positive sync	During call (+12V)	40 - 50mA
6	V1	V1 balanced video +negative sync	Privacy ON	14mA
7	3	Transmit speech to door panel	Live speech	40mA
8	T	Camera recall	Lock release	55 - 60mA
9	LB	Local Bell facility (active low)	Max	260mA
10	5	Door open signal (active low)		
11		Unused connection		
12	SB	Unused connection		
13		Unused connection		
14		Unused connection		
15	+VD	+12V out to power video splitter ( <i>Art.894</i> )		
16	4	Receive speech from door panel		
17	12VO	+12Vdc stabilized power output		
18	12Vi	+12Vdc power input		
19	LD	+12Vdc door open / auxiliary LED input		
20	C	Call tone input (electronic calltone)		

### Dip-Switch Settings

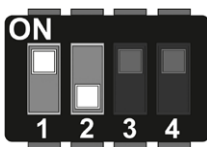
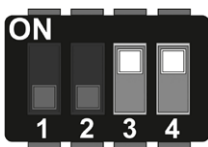
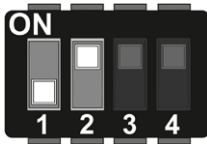
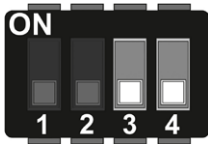
Video Mode		75 Ohm Video Termination	
Switch 1 and 2	Mode	Switch 3 and 4	Termination
	Coax (1 = ON, 2 = OFF)		Enabled (3 = ON, 4 = ON)
	Balanced (NC) (1 = OFF, 2 = ON)		Disabled (3 = OFF, 4 = OFF)



### Minimum Cable Requirement:

- 9 cores + coax for video systems using coax video signal.
- 11 cores for video systems using balanced video signal.

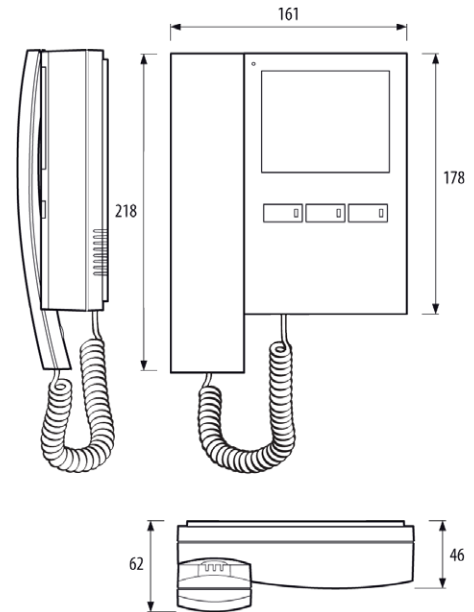
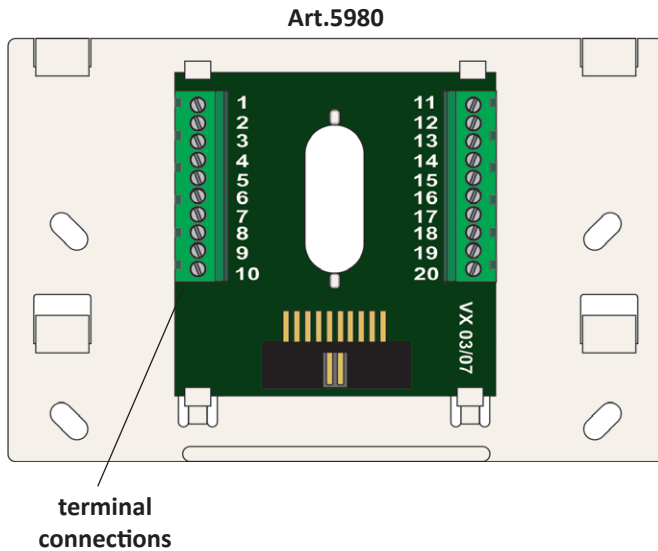





## 5000 Series Handsfree Eclipse Videophone

### Art.SL5418

The Art.SL5418 slim line colour hands free eclipse includes a talk/camera recall button, a lock release button, a privacy ON/OFF button and 3 spare service buttons. It also includes loudspeaker and call tone volume controls and brightness and hue controls. It has a programmable melody selection, number of rings and privacy duration feature and also incorporates a door opening time adjustment. Both coax and non-coax (*balanced*) video can be used by setting the relevant dip-switches on the rear of the videophone.

### User Controls

For each of the 4 available controls there are two buttons to adjust: press the left button to decrease and the right button to increase.

	Loudspeaker Volume
	Call Tone Volume Control
	Brightness Control
	Hue Control





### User Setup

The user setup allows the following features to be programmed; the number of rings, the melody type, the privacy duration time and the door opening time. The default factory presets are: 6 rings, melody 1, unlimited privacy duration (*manually controlled by user*) and 1 second door opening time.

## Programming

### Programming the Number of Rings (factory preset = 6 rings - max 9 rings)



- Press and hold the  button (for approx. 10 seconds) until the unit emits a beep and LED2 switches ON.
- Press the  button as many times as the number of rings required minus 1 (e.g. for 6 rings press the button 5 times, 0 times for 1 ring).
- Once the number of rings required has been reached, wait 5 seconds for the exit beep and LED2 to switch OFF.
- The new value is stored.

### Programming the Melody (factory preset = melody 1)

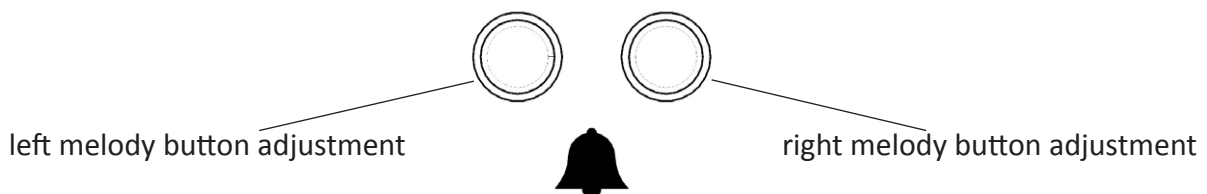

- Press and hold one of the two  buttons (for approx 10 seconds) for the call tone adjustment volume until the unit plays the current stored melody and emits a beep.
- Press the melody button again (left or right) to listen to the available melodies (maximum of 9 melodies).
- Once the chosen melody has been reached, do not press any other button and wait 5 seconds for the exit beep.
- The new melody is stored.



### Programming the Privacy Duration Time (factory preset = unlimited)

- Press and hold the  button (for approx 10 seconds) until the unit emits a beep and LED3 switches ON.
- Pressing the  button again will increase (starting from 0) the privacy duration time by 15 minutes (e.g. for a privacy duration of 1 hour press the button 4 times).
- Once the required privacy duration time has been reached, do not press any other button and wait 5 seconds for the exit beep and LED3 to switch OFF.
- The new privacy time is stored.
- To set the privacy function for unlimited time (privacy is enabled by manually pressing the  button), don't press any buttons once in privacy programming mode and wait 5 seconds for the beep and LED3 to switch OFF.



### Programming the Door Open Time (factory preset = 1 second)

- Press and hold the  button (for approx. 10 seconds) until the unit emits a beep.
- Press the  button for the number of seconds required minus 1 (e.g. for 6 seconds press the button 5 times, up to a maximum of 255 seconds).
- Once the required door opening time has been reached, wait 5 seconds for the exit beep.
- The new value is stored.

### Connections

Terminal	Signal	Function	Current Rating on +12V and +20V	
			Condition	Current (mA)
1	+20V	+20Vdc power input		
2	+20V	+20Vdc power input	Standby (+20V)	0mA
3	GND	Ground	During call (+20V)	250mA
4	GND	Ground / Coax screen	Standby (+12V)	18 - 20mA
5	V2/V	Coax centre core / V2 balanced video +positive sync	During call (+12V)	40 - 50mA
6	V1	V1 balanced video +negative sync	Privacy ON	14mA
7	3	Transmit speech to door panel	Live Speech	40mA
8	T	Camera recall	Lock Release	55 - 60mA
9	LB	Local Bell facility (active low)	Max	260mA
10	5	Door open signal (active low)		
11	LDA	12Vdc power supply input for auxiliary LED		
12	S1	Service button S1		
13	S2	Service button S2		
14		Second camera recall button for two entrance systems		
15	+VD	+12V out to power video splitter (Art.894)		
16	4	Receive speech from door panel		
17	12VO	+12Vdc stabilized power output		
18	12Vi	+12Vdc power input		
19	LD	+12Vdc door open / auxiliary LED input		
20	C	Call tone input (electronic calltone)		

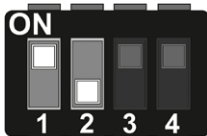
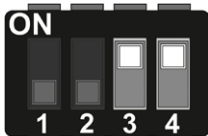
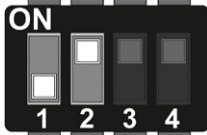
### Dip-Switch Settings

Video Mode		75 Ohm Video Termination	
Switch 1 and 2	Mode	Switch 3 and 4	Termination
	Coax (1 = ON, 2 = OFF)		Enabled (3 = ON, 4 = ON)
	Balanced (NC) (1 = OFF, 2 = ON)		Disabled (3 = OFF, 4 = OFF)

**Minimum Cable Requirement:**

- 9 cores + coax for video systems using coax video signal.
- 11 cores for video systems using balanced video signal.

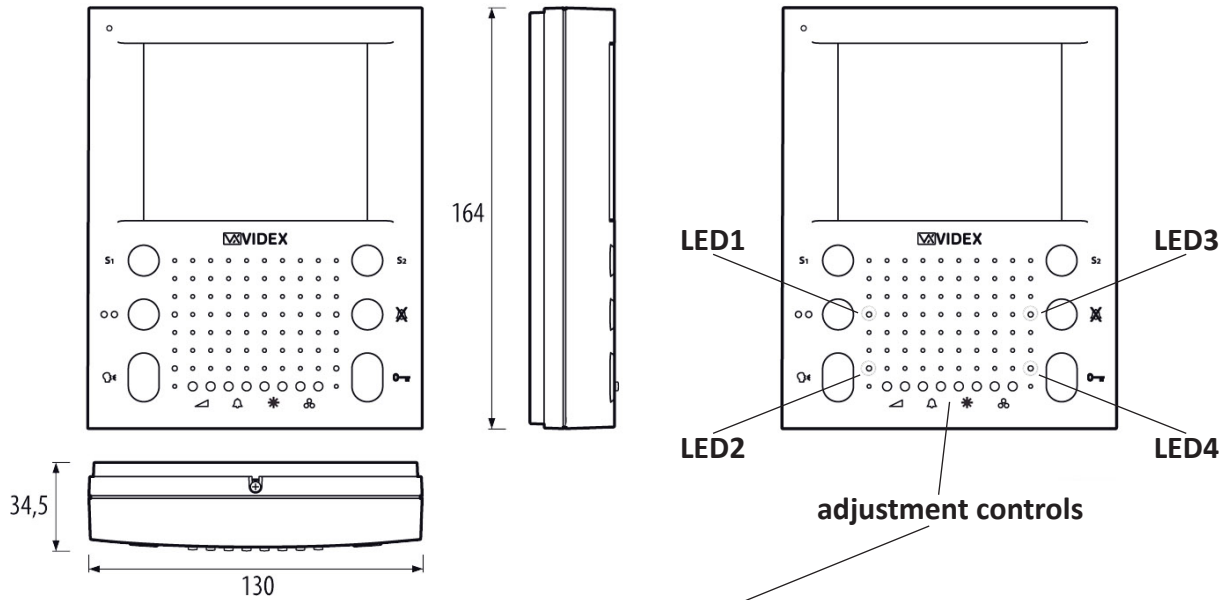

**Art.SL5418 back plate**

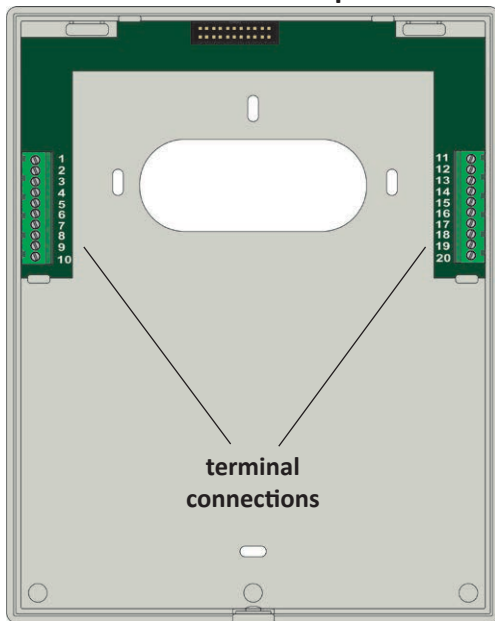

**terminal connections**

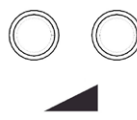
- 

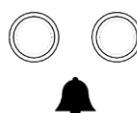
Speech line volume control. This can be adjusted during a conversation when the speech is live. Pressing the right button to increase or the left button to decrease the volume.
- 

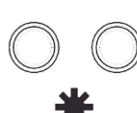
Melody volume control. This can be adjusted when the system is in standby. Pressing the right button to increase or the left button to decrease the melody volume.
- 

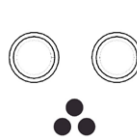
Brightness control. This can be adjusted when the speech is live after a call or after a camera recall. Pressing the right button to increase or the left button to decrease the brightness level.
- 

Hue control. This can be adjusted when the speech is live after a call or after a camera recall. Pressing the right button to increase or the left button to decrease the hue level.

**Art.SL5418 Dip-Switches**

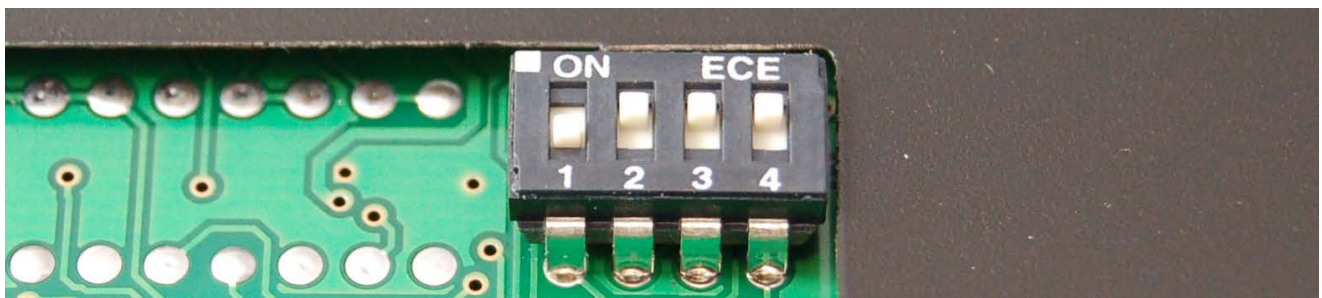

# ACCESSORIES

## Art.512A

The Art.512A is an extension sounder that can be wall mounted and will ring whenever the audiophone or videophone it is connected to rings. The 512A can be used on both audio and video systems and requires an electronic calltone input.

### Connections

Terminal	Function	Condition	Current Rating (mA)
4	Calltone input	During a call	100mA
-	0V (GND)	Max	105mA



Art.512A

## ES/1 Extension Strobe

The ES/1 is a timed strobe unit for the hard of hearing or can be used in noisy environments. The strobe will flash when a call is received and will continue flashing for an adjustable time period or until the reset button is pressed. It requires a 12Vac or dc power input and the adjustable time period can be set between 2 - 100 seconds.



ES/1

### Connections

Terminal	Function	Condition	Current Rating (mA)
Power	12Vac or dc input	Standby	6.6mA
I/P	+positive trigger	During a call	160 - 175mA
+O/P	12Vdc output	Max	180mA
GND	0V (ground)		
Reset	Switched 0V reset		
NC	Normally closed relay connection		
CO	Common relay connection		
NO	Normally open relay connection		

## Art.506N relay

The Art.506N universal boxed 12/24V ac/dc double pole relay which can be used for many functions. Its changeover relay contacts are rated at 240Vac 5A. It also includes low current transistor switched inputs (+positive and -negative triggers). One important function of the Art.506N relay when used on this system is to switch the video signal on multiple door systems. Alternatively, the Art.520MR can be used which combines an Art.506N relay and an Art.520M PSU into one housing (see page 12). The Art.506N relay can also be used to switch a volt free contact to a gate or barrier controller and also used to drop power off to a fail safe mag lock.

### Connections

Terminal	Function	
1	24V ac or DC input	
2	12V ac or DC input	
3	0V switched input ( <i>link to GND when not using terminal 4</i> )	
4	Switched +positive input	
5	Ground ( <i>0V power when using switch +positive input</i> )	
CO1	Common relay 1 connection	Max. current and voltage for each relay 5A @ 230Vac
NO1	Normally open relay 1 connection	
NC1	Normally closed relay 1 connection	
CO2	Common relay 2 connection	
NO2	Normally open relay 2 connection	
NC2	Normally closed relay 2 connection	



Art.506N

# DESKMOUNT KITS

## Audio Deskmount Kits

There are two types of audio deskmount kits the Art.3038 for the 3000 series audiophones and the Art.5138 for the 5000 series audio apartment stations.

### Art.3038

The Art.3038 audio deskmount kit has an angled metal base that comes with 1.5m flexible cable and junction box to allow all full base 3000 series audiophones to be desk mounted. The metal base is a powder coated white finish.

**Base Plate Dimensions:**

**77mm [W] x 210mm [L]**

**Elevation: 24°**

**Cable length: 1.5m**

**Junction Box Dimensions:**

**110mm [W] x 70mm [H] x 30mm [D]**

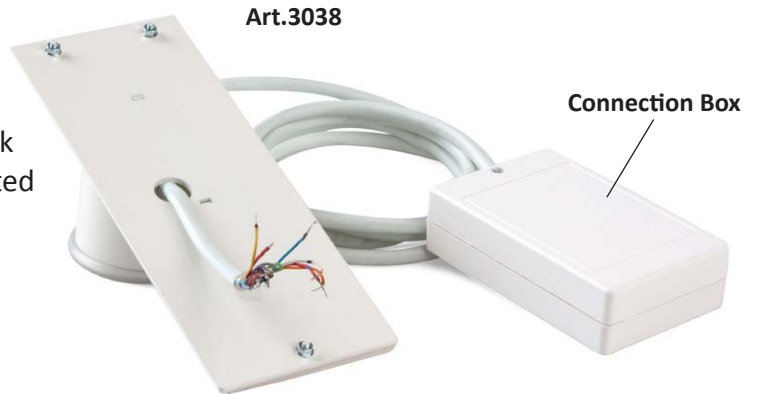

### Art.5138

Art.5138

The Art.5138 audio deskmount kit has an angled 3mm brushed stainless steel mounting plate and base complete with cable and wall mount connection box. It's suitable for all 5000 series audio apartment stations.



**Back Plate Dimensions: 75mm [W] x 165mm [H]**

**Base Dimensions: 116mm [W] x 169mm [H] x 120mm [D]**

**Cable length: 1.5m**

**Junction Box Dimensions:**

**110mm [W] x 70mm [H] x 30mm [D]**

Art.3038 / Art.5138 Connection Box

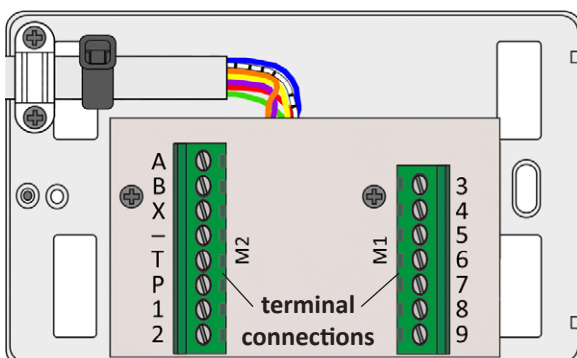

Art.3038 / Art.5138 Connection Box Colour Code	
Terminal	Cable Colour
A	White
B	Red
X	Yellow
-	Black
T	Blue
P	White/Black
1	Orange
2	Green
3	Brown
4	Grey
5	Light Blue
6	Violet
7	Red/Black
8	Red/Green
9	Red/Blue

## Video Deskmount Kits

There are two types of video deskmount kits the Art.36931 for the 3600 series videophones and the Art.5931 for the 5000 series video handsfree eclipse monitors.

### Art.36931

Art.36931

The Art.36931 video deskmount kit has an angled 3mm brushed stainless steel mounting plate and base complete with cable and wall plug and also a wall mountable connection box the Art.895. It's suitable for all 3600 series videophones.



**Plate Dimensions: 162mm [W] x 180mm [H]**

**Base Dimensions: 116mm [W] x 215mm [H] x 149mm [D]**

Art.895 Wall Box

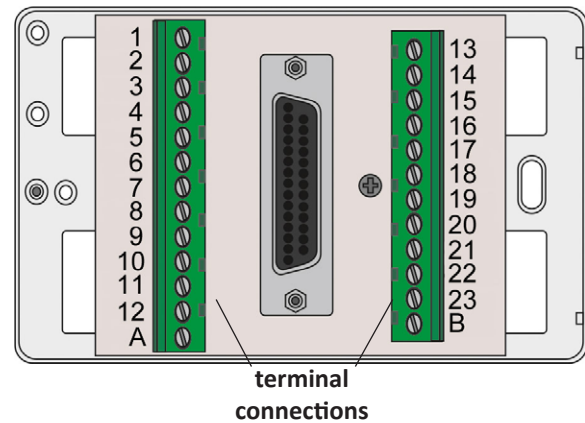

Art.3612 / Art.3618 / Art.SL5418 Colour Code and Terminal Connections				
Art.895	D-Plug Wire Colour Code	Art.3612 (Art.5980)	Art.3618 (Art.5980)	Art.SL5418
1	Red/Black	1	1	1
2	Brown	2	2	2
3	Light Blue	3	3	3
4	Red	4	4	4
5	White	5	5	5
6	Grey	6	6	6
7	Yellow	7	7	7
8	Blue	8	8	8
9	Black	9	9	9
10	Red/Green	10	10	10
11	Orange	11	11	12
12	Green	12	12	13
14	Red/Blue	13	15	14
15	Pink	14	16	15
16	Red/Yellow	15	17	16
17	Violet	16	18	17
18	Red/White	19	19	18
19	White/Black	20	20	20

Please note that the following terminals A, B, 13, 20, 21, 22 and 23 are **not** connected internally on the Art.895 mounting box

## Art.5931

The Art.5931 video deskmount kit like the Art.36931 has an angled 3mm brushed stainless steel mounting plate and base complete with cable and D-Plug and also an Art.895 wall mountable connection box. It's suitable for all video Eclipse series videophones.

**Plate Dimensions: 130mm [W] x 164mm [H]**  
**Base Dimensions: 116mm [W] x 169mm [H] x 126mm [D]**

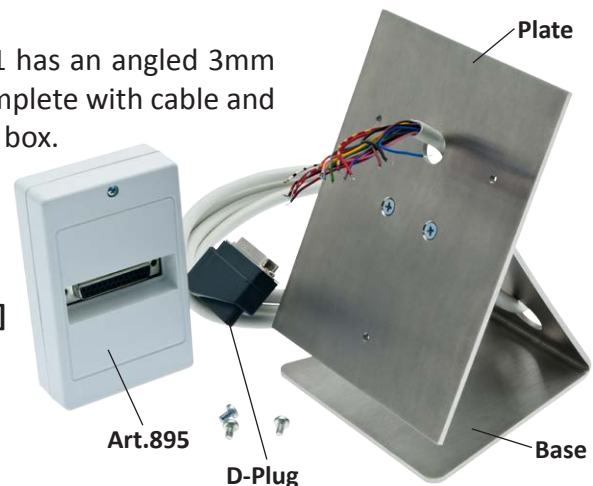

# INSTALLATION

## Initial Installation Checks

The wiring diagrams towards the back of this manual should be followed carefully. Heavy duty conductors on wiring diagrams are shown heavily outlined in some instances where voltage drop is experienced then these wires should be doubled up.

- Check that all components are free from damage before installing (Do not proceed with the installation in the event of damage).
- Keep all packaging away from children.
- Do not obstruct the ventilation openings or slots on any of the devices.
- All connections to mains voltages must be made to the current national standards (IEE Wiring regulations)
- Install an appropriate fused spur or isolation switch to isolate the mains.
- Isolate the mains before carrying out any maintenance work on the system.
- All intercom and access control cables must be routed separately from the mains.

## Lock Release Wiring and Back EMF Protection

When fitting an electric lock release back EMF protection will be required. If fitting an AC lock release then a 100nF ceramic disc capacitor must be fitted across the terminals on the lock. If fitting a DC lock release (fail secure or fail safe) then a 1N4002 diode must be fitted across the terminals on the lock.

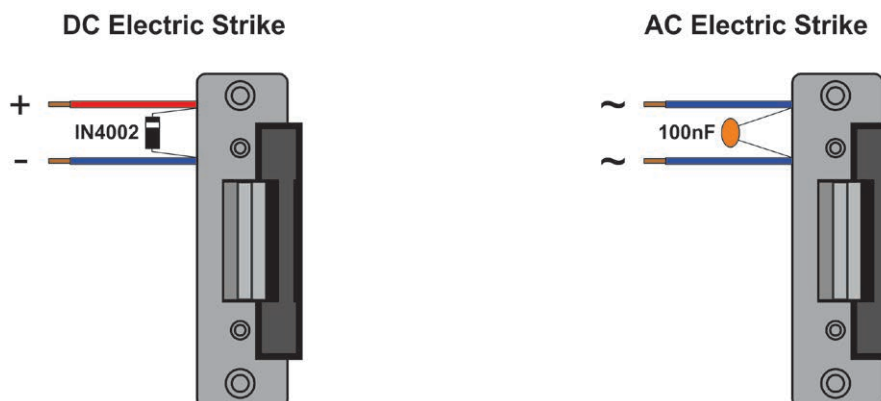



# CABLE TYPE AND CABLE SIZE GUIDE

## Cable Types

The following cable types described below are measured in mm<sup>2</sup> for the cross sectional area (CSA) for each conductor (core) within the cable bundle. The tables show the distances in metres between system components. All cable types are categorised using the AWG (American Wire Gauge).

Suitable cables for this system are a BT type telephone cable CW1308 and a YY cable (other similar or equivalent cables are also suitable). When selecting a particular cable type care must be taken to ensure that excessive voltage drop is avoided and the lowest possible resistance is achieved. Use the following cable types and the tables as a guide to ensure that the best possible performance is achieved.

### **CW1308 Telephone cable (CSA 0.22mm<sup>2</sup> AWG 24 - Maximum Resistance 97.8 Ohm/km)**

CW1308 is an internal grade cable and is available in 3 pair, 4 pair, 6 pair, 10 pair, 12 pair, 15 pair, 20 pair and 25 pair.

### **CW1308B Telephone cable (CSA 0.22mm<sup>2</sup> AWG 24 - Maximum Resistance 97.8 Ohm/km)**

CW1308B is an internal or external grade cable (if used externally must be protected) and is available in 10 pair and 20 pair.

### **CW1128 Telephone cable (CSA 0.22mm<sup>2</sup> AWG 24 - Maximum Resistance 96 Ohm/km)**

CW1128 is an external grade poly-filled cable (if used externally must be protected) and is available in 2 pair, 5 pair, 10 pair and 20 pair.

### **CW1128 / CW1198 Telephone cable (CSA 0.5mm<sup>2</sup> AWG 20 - Maximum Resistance 91 Ohm/km)**

CW1128 / CW1198 is an external grade poly-filled armoured cable (for direct burial) and is available in 2 pair, 5 pair, 10 pair and 20 pair.

### **CAT5e (CSA 0.2mm<sup>2</sup> AWG 24 - DC loop resistance <0.188 Ohm/m, converts to 94 Ohm/km)**

CAT5e is an internal grade cable and is available in 4 pair. Please note that if CAT5e cable is going to be used then the DC characteristics above must be met by measuring the resistance of the cable directly or by consulting the manufacturer's datasheet.

## YY Control Cable

**(CSA 0.5mm<sup>2</sup> AWG 24 - Maximum Resistance 39 Ohm/km)**

**(CSA 0.75mm<sup>2</sup> AWG 18 - Maximum Resistance 26 Ohm/km)**

**(CSA 1.0mm<sup>2</sup> AWG 17 - Maximum Resistance 19.5 Ohm/km)**

**(CSA 1.5mm<sup>2</sup> AWG 15 - Maximum Resistance 13.3 Ohm/km)**

**(CSA 2.5mm<sup>2</sup> AWG 13 - Maximum Resistance 8 Ohm/km)**

YY control cable is an internal or external grade cable (if used externally must be protected) and is available in 4 Core, 7 Core, 12 Core & 18 Core. Each cable comes with numbered cores in white on a black sheath and also includes a green/yellow earth core.

## Video System Cables

On video systems when a balanced video signal (V1/V2) is not being used then a coax video signal can be used instead. Depending on the cable distance between system components the following coax cables can be used. When selecting a coax cable we suggest using a BC type of coax cable, BC stands for bare copper. Copper coated steel (CCS) versions should not be used.

### RG59(BC)

RG59(BC) is an internal grade coax cable and can be used with distances of up to 200m.

### RG11(BC)

RG11(BC) is an internal grade coax cable and can be used with distances of up to 600m.

### CT100

CT100 is an external grade (protected) coax cable and can be used with distances of up to 200m.

### CT125

CT125 is an external grade (protected) coax cable and can be used with distances of up to 600m.

## Connections from door panel to Audiophones / Videophones

Connection	50m	100m	200m	300m	400m
Power	0.35mm <sup>2</sup>	0.5mm <sup>2</sup>	0.75mm <sup>2</sup>	1.0mm <sup>2</sup>	1.5mm <sup>2</sup>
All others	0.25mm <sup>2</sup>	0.35mm <sup>2</sup>	0.5mm <sup>2</sup>	0.75mm <sup>2</sup>	1.0mm <sup>2</sup>

Maximum acceptable resistance for power terminal connections = 5 Ohms or less, for all other connections = 10 Ohms or less for best possible performance.

## Connections for power supply output to door panel and lock release

	50m	100m
Connection	0.5mm <sup>2</sup>	0.75mm <sup>2</sup>

The power supply ideally should be located as close to the door panel as possible, typically between 20 - 30m. Maximum acceptable resistance for above connections = 3 Ohms or less for best possible performance.

## Audiophones and Apartment Stations

Model	Min. Cores	50m	100m	200m	300m	400m	500m
Art.3011	5	4 pair CW1308 or CAT5e	6 pair CW1308 or 7 core 0.5mm <sup>2</sup> YY	10 pair CW1308 or 12 core 0.5mm <sup>2</sup> YY	12 pair CW1308 or 12 core 0.5mm <sup>2</sup> YY	12 core 0.5mm <sup>2</sup> YY	12 core 1.0mm <sup>2</sup> YY
Art.3111	5	4 pair CW1308 or CAT5e	6 pair CW1308 or 7 core 0.5mm <sup>2</sup> YY	10 pair CW1308 or 12 core 0.5mm <sup>2</sup> YY	12 pair CW1308 or 12 core 0.5mm <sup>2</sup> YY	12 core 0.5mm <sup>2</sup> YY	12 core 1.0mm <sup>2</sup> YY
Art.3112	5	4 pair CW1308 or CAT5e	6 pair CW1308 or 7 core 0.5mm <sup>2</sup> YY	10 pair CW1308 or 12 core 0.5mm <sup>2</sup> YY	12 pair CW1308 or 12 core 0.5mm <sup>2</sup> YY	12 core 0.5mm <sup>2</sup> YY	12 core 1.0mm <sup>2</sup> YY
Art.5112	6	4 pair CW1308 or CAT5e	6 pair CW1308 or 7 core 0.5mm <sup>2</sup> YY	10 pair CW1308 or 12 core 0.5mm <sup>2</sup> YY	12 pair CW1308 or 12 core 0.5mm <sup>2</sup> YY	12 core 0.5mm <sup>2</sup> YY	12 core 1.0mm <sup>2</sup> YY
Art.5118	6	4 pair CW1308 or CAT5e	6 pair CW1308 or 7 core 0.5mm <sup>2</sup> YY	10 pair CW1308 or 12 core 0.5mm <sup>2</sup> YY	12 pair CW1308 or 12 core 0.5mm <sup>2</sup> YY	12 core 0.5mm <sup>2</sup> YY	12 core 1.0mm <sup>2</sup> YY

Whenever possible the speech line connections 1 and 2 (*refer back to pages 16 - 19*) should be twisted with the speech GND connection as pairs. Maximum acceptable resistance for power terminal connections = 5 Ohms or less, for all other connections = 10 Ohms or less for best possible performance.

It should be noted that if a multi-core cable is used and the overall resistance of the cable is higher than that stated above it is possible to double up on core connections to both increase the CSA of the connection and reduce the overall resistance of the cable.

## Videophones and Handsfree Eclipse

Art.3612						
Video Signal	Min. Cores	50m	100m	200m	300m	400m
Balanced	11	6 pair CW1308	6 pair CW1308 or 12 core 0.5mm <sup>2</sup> YY	15 pair CW1308 or 12 core 0.5mm <sup>2</sup> YY	Not recommended	Not recommended
Coax	9 + coax	6 pair CW1308 + RG59(BC)	6 pair CW1308 or 12 core 0.5mm <sup>2</sup> YY + RG59(BC)	15 pair CW1308 or 12 core 0.5mm <sup>2</sup> YY + RG59(BC)	12 core 0.75mm <sup>2</sup> YY + RG11(BC)	12 core 1.0mm <sup>2</sup> YY + RG11(BC)

Whenever possible the speech line connections 3(6) and 4(7) (*refer back to page 20*) should be twisted with the speech GND connection 5(8) as pairs. Maximum acceptable resistance for power terminal connections = 5 Ohms or less, for all other connections = 10 Ohms or less for best possible performance. Where coax cable is used 'V' is the centre signal core and 'M' is the screen and should measure no higher than 75 Ohms.

Art.3618						
Video Signal	Min. Cores	50m	100m	200m	300m	400m
Balanced	11	10 pair CW1308	12 pair CW1308 or 12 core 0.5mm <sup>2</sup> YY	15 pair CW1308 or 12 core 0.5mm <sup>2</sup> YY	Not recommended	Not recommended
Coax	9 + coax	10 pair CW1308 + RG59(BC)	12 pair CW1308 or 12 core 0.5mm <sup>2</sup> YY + RG59(BC)	15 pair CW1308 or 12 core 0.5mm <sup>2</sup> YY + RG59(BC)	12 core 1.0mm <sup>2</sup> YY + RG11(BC)	12 core 1.5mm <sup>2</sup> YY + RG11(BC)

Whenever possible the speech line connections 3(7) and 4(16) (*refer back to page 24*) should be twisted with the GND connections (3/4) as pairs. Maximum acceptable resistance for power terminal connections = 5 Ohms or less, for all other connections = 10 Ohms or less for best possible performance. Where coax cable is used 'V' is the centre signal core and 'M' is the screen and should measure no higher than 75 Ohms.

Art.SL5418						
Video Signal	Min. Cores	50m	100m	200m	300m	400m
Balanced	11	6 pair CW1308	6 pair CW1308 or 12 core 0.5mm <sup>2</sup> YY	15 pair CW1308 or 12 core 0.5mm <sup>2</sup> YY	Not recommended	Not recommended
Coax	9 + coax	10 pair CW1308 + RG59(BC)	12 pair CW1308 or 12 core 0.5mm <sup>2</sup> YY + RG59(BC)	15 pair CW1308 or 12 core 0.5mm <sup>2</sup> YY + RG59(BC)	12 core 1.0mm <sup>2</sup> YY + RG11(BC)	12 core 1.5mm <sup>2</sup> YY + RG11(BC)

Whenever possible the speech line connections 3(7) and 4(16) (*refer back to page 27*) should be twisted with the GND connections (3/4) as pairs. Maximum acceptable resistance for power terminal connections = 5 Ohms or less, for all other connections = 10 Ohms or less for best possible performance. Where coax cable is used 'V' is the centre signal core and 'M' is the screen and should measure no higher than 75 Ohms.

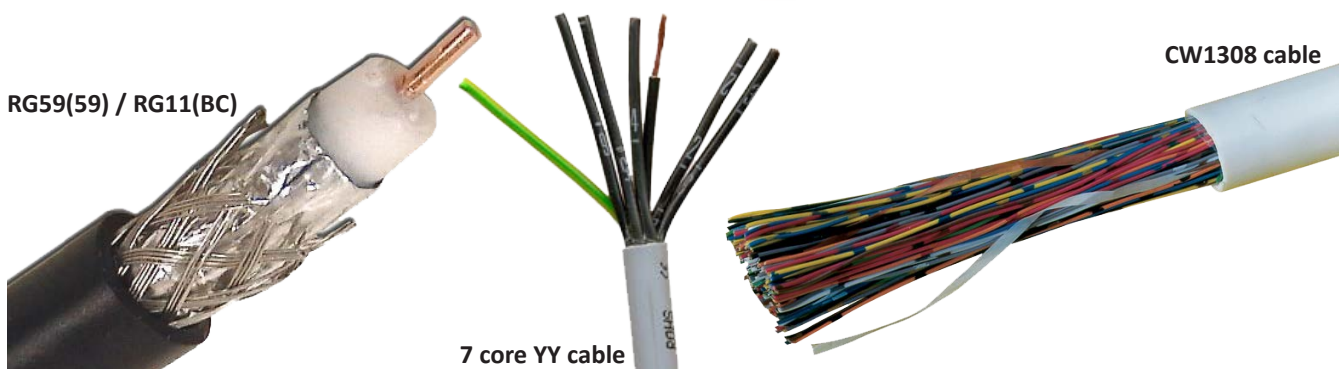

## VProx Proximity Reader

It should be noted that when cabling for the VP/PM proximity reader a separate cable from the intercom cable must be used between the reader itself and the control equipment.

Connections	50m	100m	200m
- (GND)	0.25mm <sup>2</sup>	0.5mm <sup>2</sup>	0.75mm <sup>2</sup>
+12V	0.25mm <sup>2</sup>	0.5mm <sup>2</sup>	0.75mm <sup>2</sup>
RK	0.25mm <sup>2</sup>	0.5mm <sup>2</sup>	0.75mm <sup>2</sup>
LR	0.25mm <sup>2</sup>	0.5mm <sup>2</sup>	0.75mm <sup>2</sup>
LG	0.25mm <sup>2</sup>	0.5mm <sup>2</sup>	0.75mm <sup>2</sup>
<b>Cable Type</b>	3 pair CW1308 or CAT5e	7 core 0.5mm <sup>2</sup> YY	7 core 0.75mm <sup>2</sup> YY

Whenever possible the RK data connection should be twisted with the -(GND) connection as pairs. Maximum acceptable resistance for all terminal connections = 10 Ohms or less for best possible performance. Maximum overall distance between reader and CPU = 200m. Please note that while it is ok to double up on the +12V and -(GND) power connections it is not recommended to double up on the RK data connection as this can effect the readers performance due to capacitance effects.

For all other types of proximity system please consult the manufacturers installation guide for cabling requirements.

## High Voltage and Low Voltage Cables

When laying high voltage cables (*mains*) and low voltage cables (*intercom and signal*) they should always be routed separately in different ducting. If for any reason they are in the same ducting whether internally or externally they should always be kept separate within the ducting itself, typically there should be a gap of approximately 12" (inches) between the sets of high voltage and low voltage cables. If necessary they should be cable tied off to keep them as far apart as possible.

# BLOCK DIAGRAMS

## Audio System Block Diagram

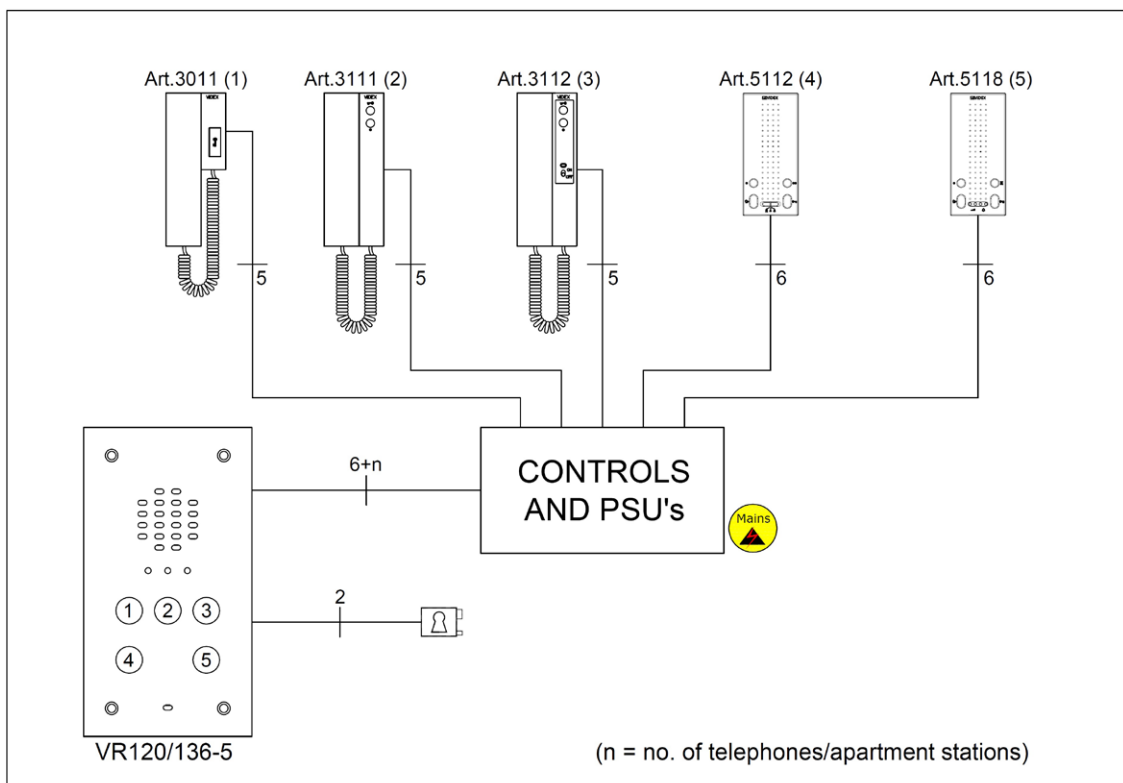

Additional cores will be required for auxiliary devices such as push to exit buttons, fireman switches, proximity access control, an induction loop and fail safe lock release etc. If more than one VR120/136 audio intercom panel is being used then an additional core for the busy (*BSY*) connection between intercom panels will be required.

### Video System Block Diagram

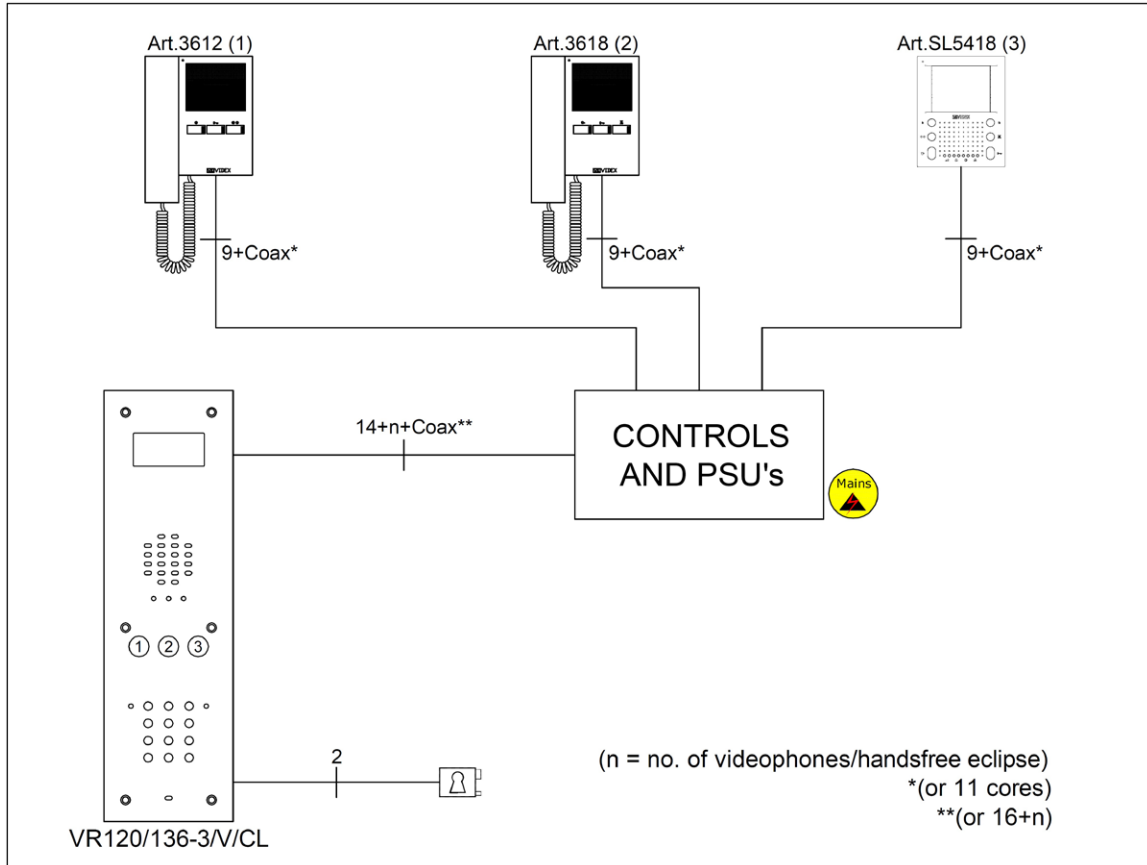

Additional cores may be required for auxiliary items such as push to exit buttons, fireman switch, proximity access control, an induction loop and fail safe lock release etc. If more than one VR120/136 video intercom panel is being used then an additional core for the busy (*BSY*) connection between intercom panels will be required.

The video block diagram shows all videophones coming back to one point with all the video distributors (*Art.316 or Art.894*) at that point. It is also possible to spread the video distributors around the building at a more localised junction point to make cabling for the videophones easier.



## PANEL AND BACK BOX INSTALLATION

The following guide lines should be followed with respect to the installation and care of the VR120 panel and accompanying back box. The back box should be adequately secured to the wall to prevent risk of injury.

- To prevent water ingress to the VR120 panel ensure that a good seal between the back box and the face plate itself is made. The neoprene seal on the face plate will offer this as long as the back box front is flush with the wall surface. Always ensure the panel is tightened sufficiently to compress the neoprene seal.
- In the event of gaps due to uneven walls we suggest using a silicon sealant be used. In the event of water ingress to the back box we would also suggest drilling 3x4mm holes at the bottom of the back box to allow any collection of water to escape.
- Always ensure all cable entry points are sufficiently sealed to prevent water ingress (*refer to Fig.1, Fig 2 and Fig.3*). All cables should loop down and then back up to the termination connections to avoid any water travelling along the cable and onto the pcb.

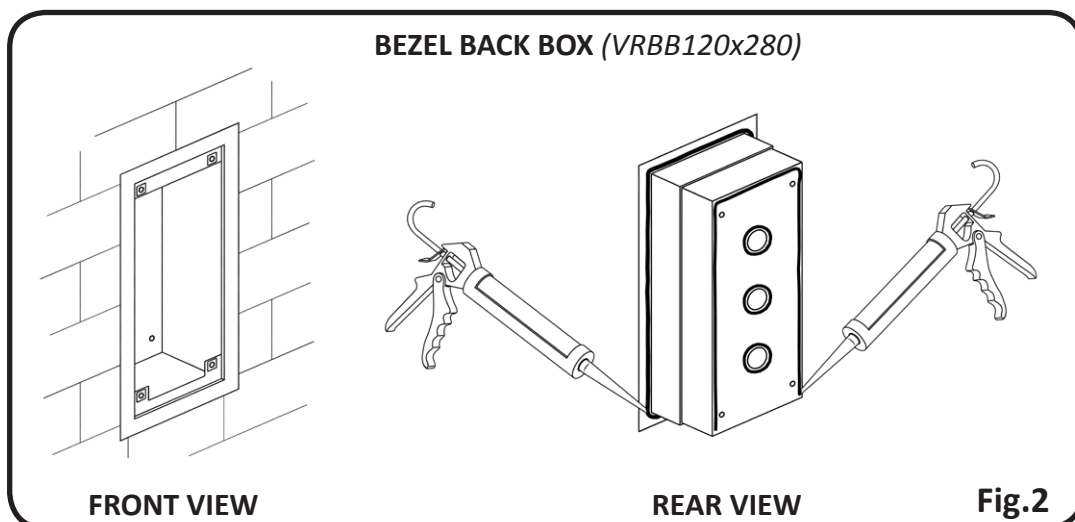
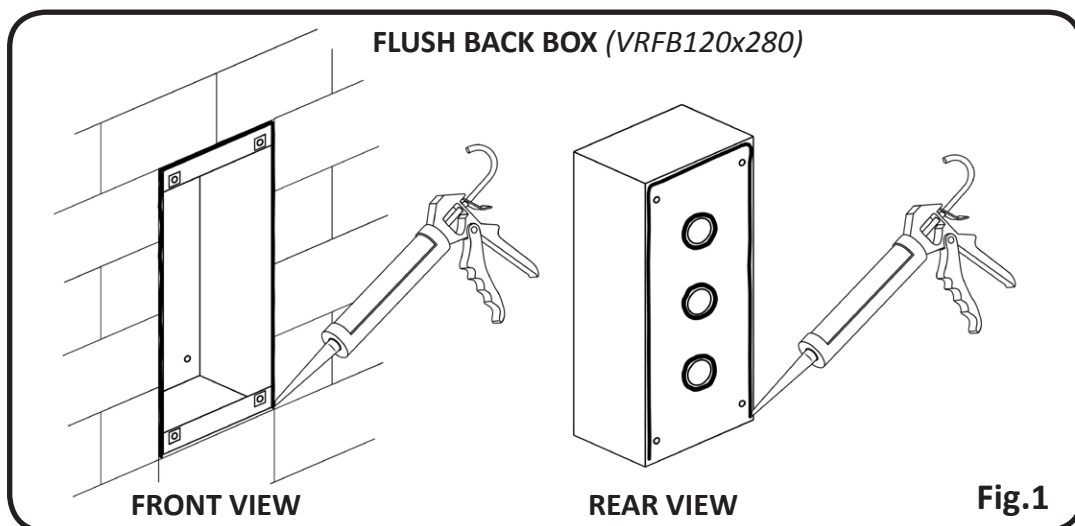

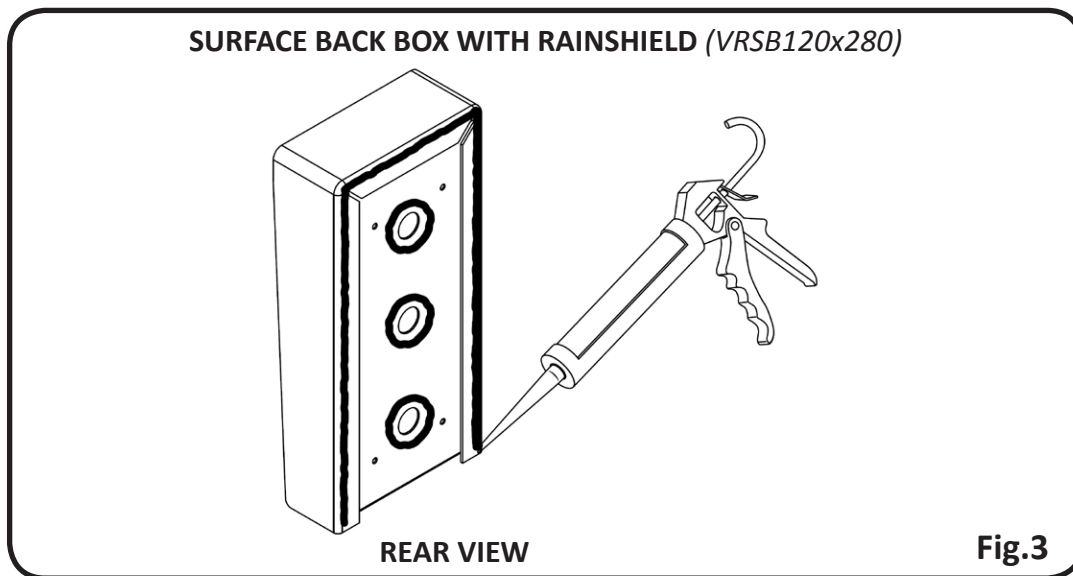

## PANEL CARE

The VR120 door panel is manufactured from brushed 12 Gauge 304 grade stainless steel. It is important that the fascia is cleaned on regular occasions to prevent dirt build up and tarnishing of the metal. A general household metal polish can be used but care should be taken to follow the grain of the metal when polishing and always only polish in one direction with a soft cloth to avoid light scratching of the fascia. Also try to avoid any polish build up around the call button which may prevent the button from operating correctly.

The table below identifies the methods of cleaning.

To Clean	Method
Finger prints	Detergent and warm water or a household polish.
Routine cleaning	Soap, detergent or dilute (1%) ammonia solution in warm water.
Staining and discolouration	Mild non-scratching creams and polishes. Take care to avoid build up of creams in the buttons which could cause sticking.

### Cleaners that cannot be used:

- Chloride containing cleaners.
- Hydrochloric acid based cleaners.
- Sidol stainless steel cleaner (*can affect engraving*).
- Hydrochloride bleaches.
- Silver cleaners.



## TESTING THE INSTALLATION

- Check all the connections have been made correctly and are terminated properly into the terminals and then power up the system.
- Check the voltage output on all of the power supplies.
- Call all the apartments in turn. Check for the call tone to the apartment, speech in both directions, video signal (*video systems only*) and that the lock release operates.
- If the volume of speech needs to be adjusted, this can be done by adjusting the volume POTs on the rear of the VX136 amplifier at the door panel. On audio systems using 5112 and 5118 apartment stations this can be adjusted on the apartment station themselves (*refer back to pages 17 - 18*). On video systems speech volumes may also be adjusted on the videophones (*refer back to pages 19 - 28*).
- If the call tone volume needs adjusting this can be done at each handset. The method in which to increase or decrease the call tone volume will depend on the handset being fitted (*refer back to pages 16 - 28*).
- For systems with a trade facility set the time clock ON/OFF times (*Use the instructions supplied with the timeclock or refer to page 45*). Check the trade button only works when the time clock is ON.

**Safety Note:** The VR120 panel must be earthed to its back box (with the earth strap provided) and then the back box earthed to the buildings earth connection.

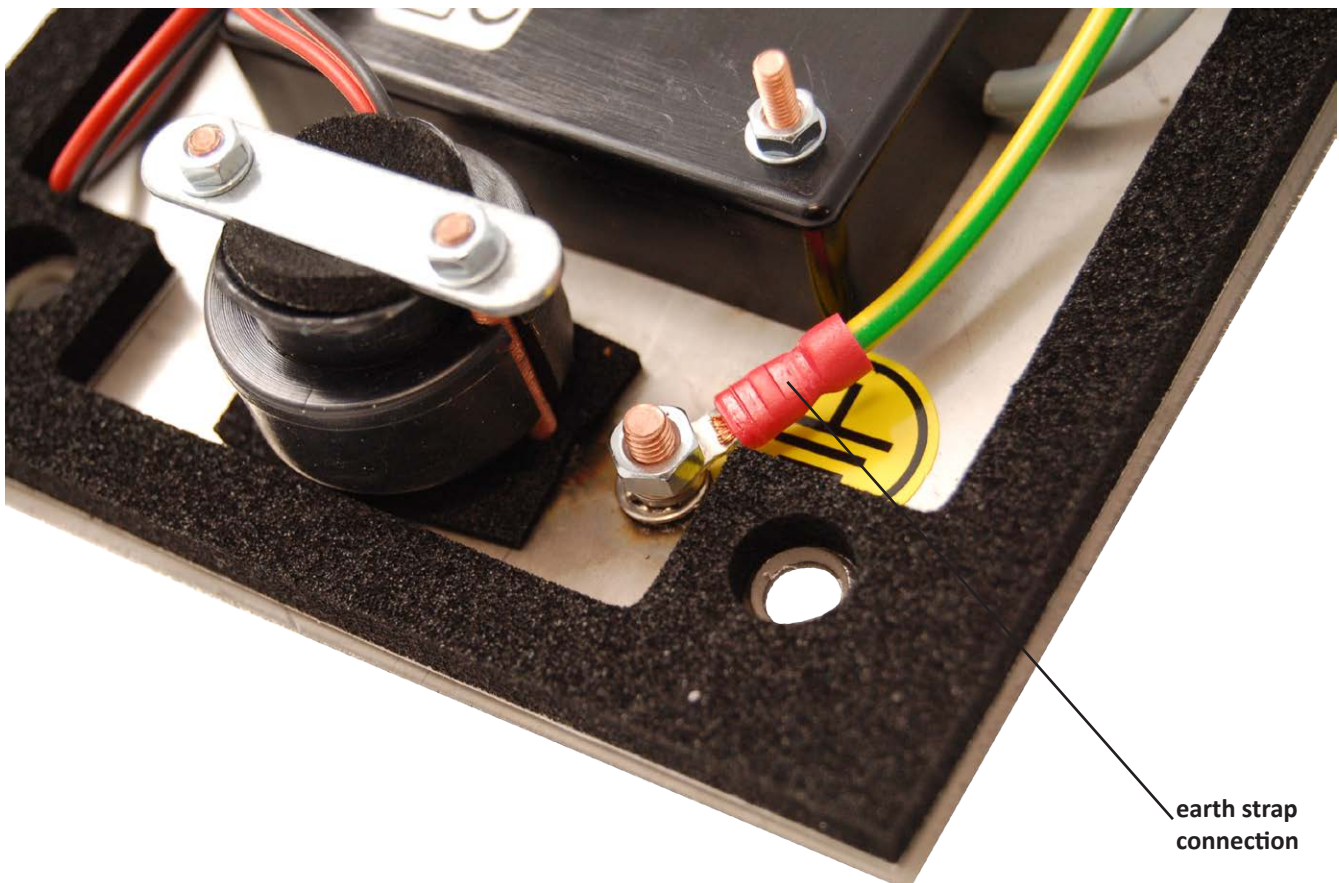



# ACCESSORIES CONNECTION GUIDE

**B**elow shows how to connect an extension sounder (*Art.512A*) and an extension strobe (*ES/1*) when fitted to an audio system. The same connections can be made when connecting to a video system. In some instances a separate 12Vdc power supply may be required when connecting an extension strobe when several 12Vdc devices are connected on the system, this is to avoid excessive current draw on the existing power supply.

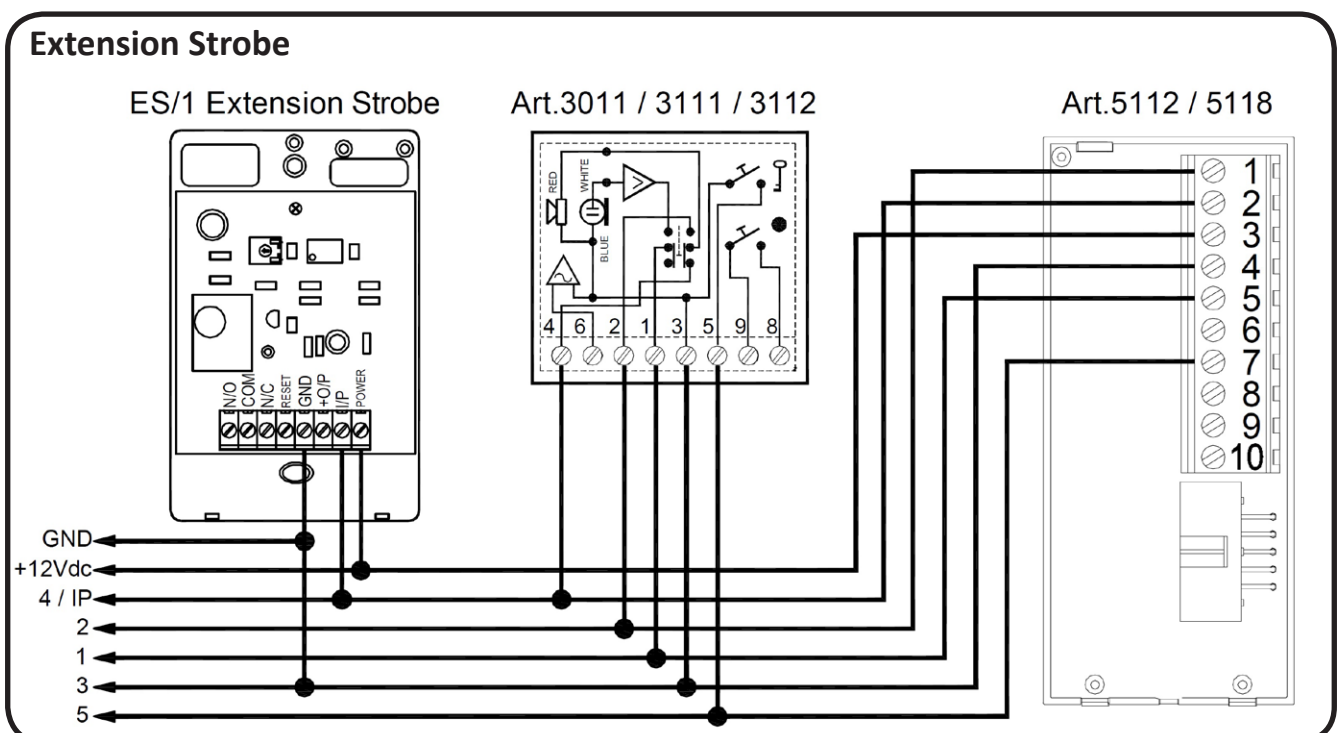
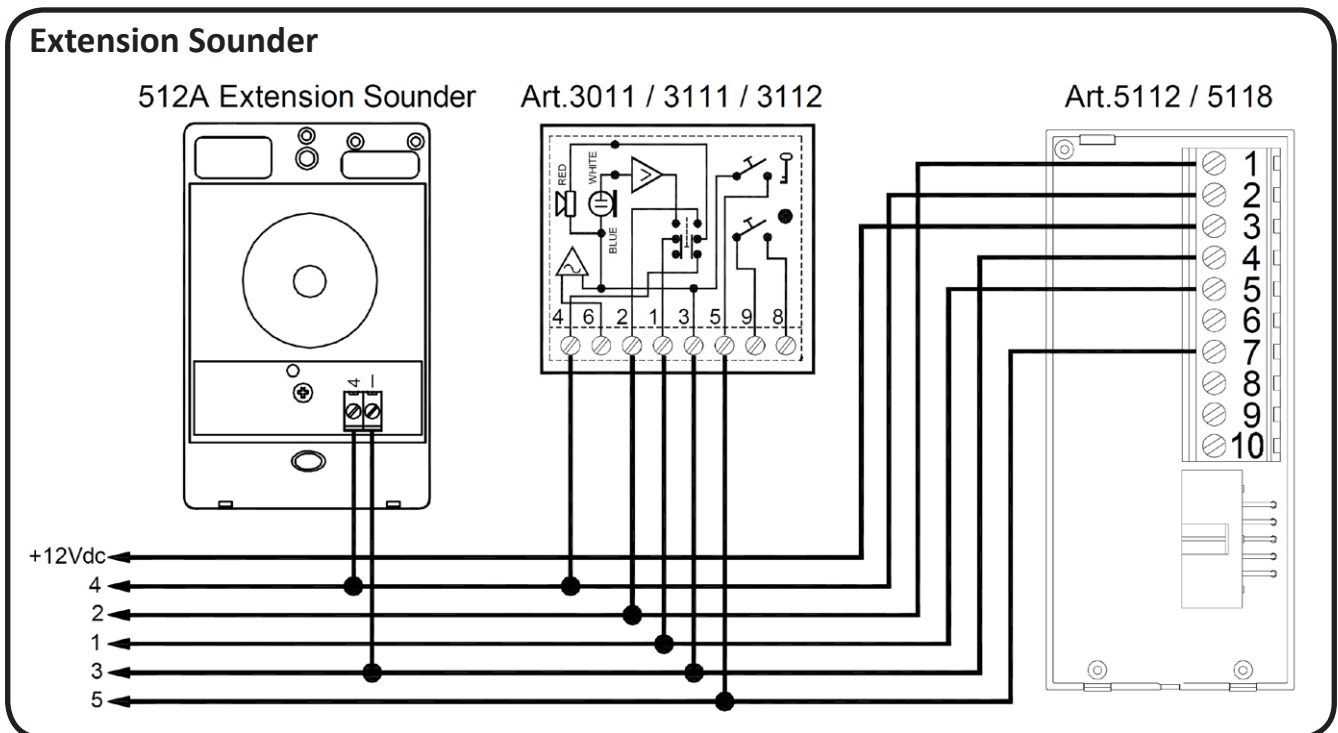

### Push to Exit (push to make)

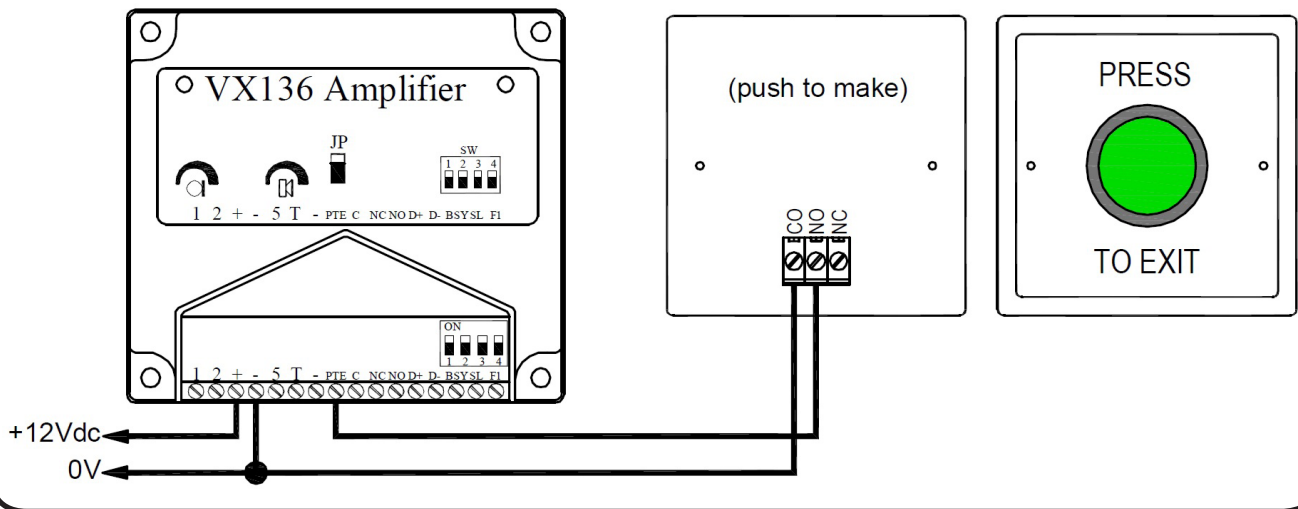

### Trade Button (Art.701T Timeclock)

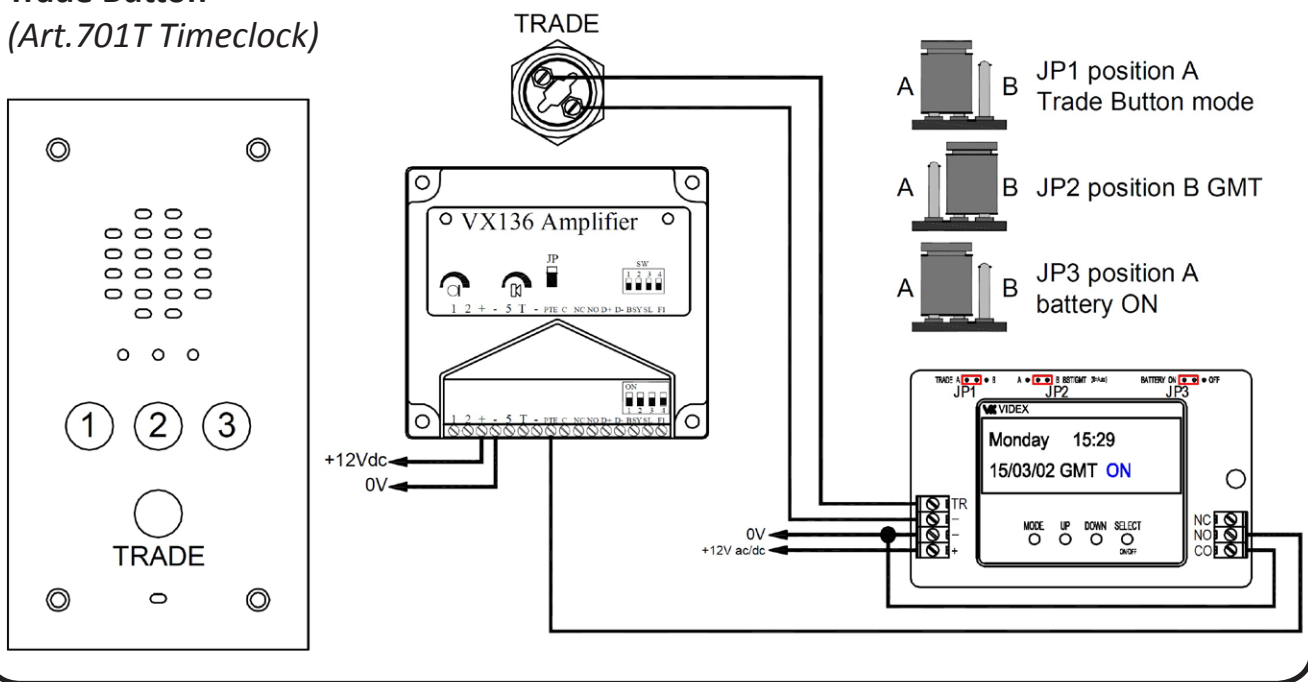

### Dry Relay Contacts (Art.506N Relay)

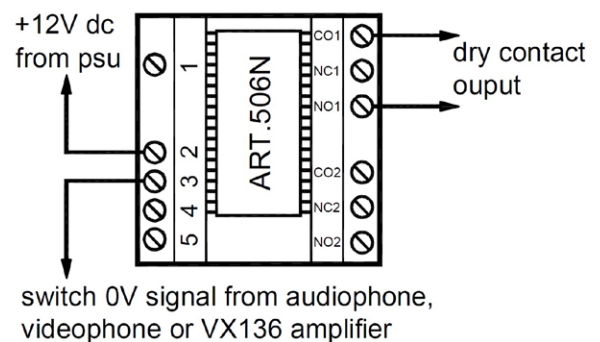
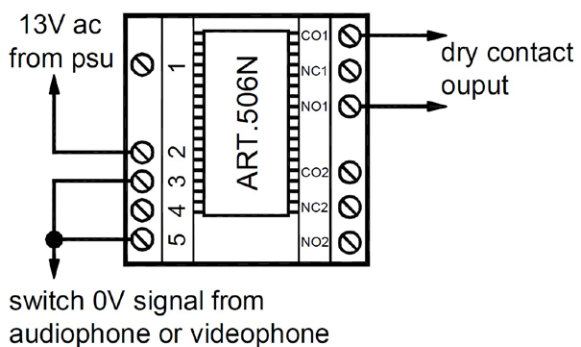

# CODELOCK PROGRAMMING GUIDE

## VR4KCLM codelock

The VR4KCLM codelock includes two relays (5A contacts), two push to exit inputs SW1 and SW2 which are both switched 0V inputs and can have up to two 4 to 8 digit access codes programmed (one per relay). The relay times can be programmed from 1 second up to 99 seconds or by setting the relay time to 00 will latch the relay into the open or closed position. To latch the relay, type in the access code followed by the **ENTER** button and to unlatch the relay, type in the access code followed by the **CLEAR** button.

### Initial Programming

All programming is carried out using the codelock keypad. The programming menu is protected by an engineer's code. The factory default engineer's code is 111111 (6x1). This code can be changed to any 4 to 8 digit engineer's code during the programming, but must be different to the access codes used to gain entry. Follow the flow chart below to setup the system:-

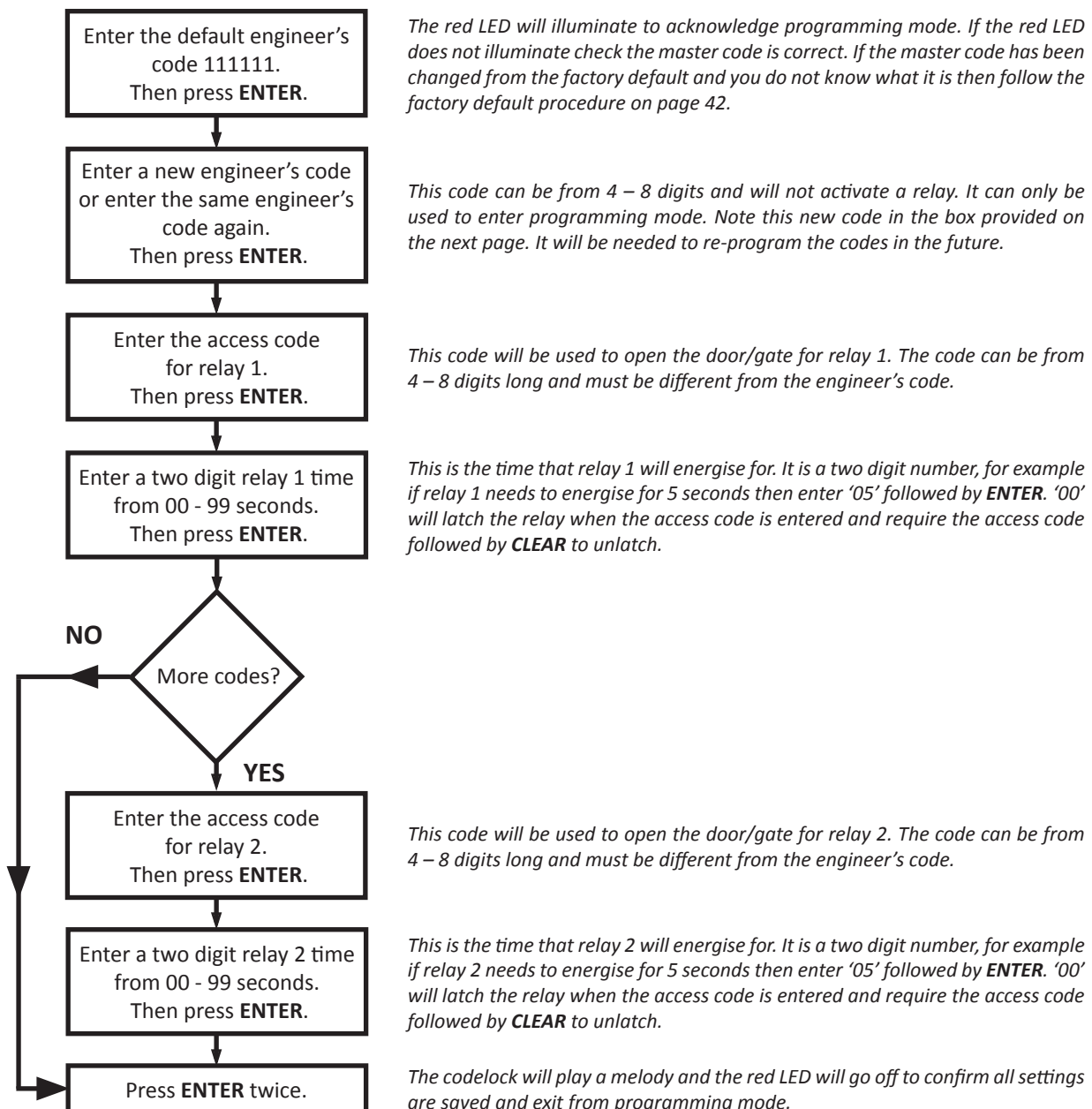

## VR4KCLM Codelock Programming

Engineer's Code	
Relay 1 Access Code	
Relay 2 Access Code	
Relay 1 Time	
Relay 2 Time	

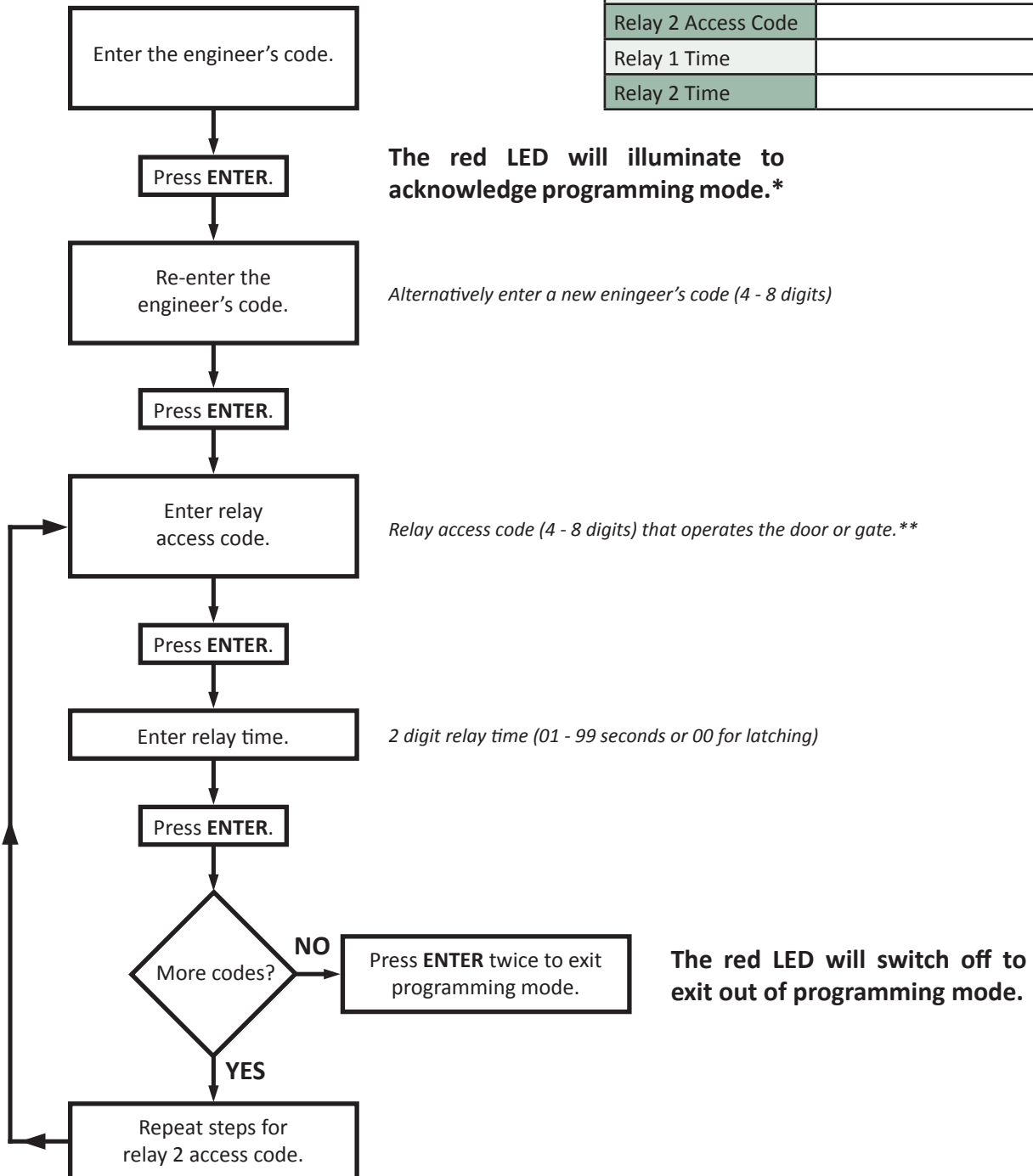

### NOTES:

\*If the red LED does not illuminate then the engineer's code is incorrect. Follow the factory default procedure below.

\*\*On the first loop of the flow chart the access code is for relay 1 on the second loop the access code is for relay 2.

### Factory Default Procedure

1. Remove the power from the keypad.
2. Press and hold the enter button while re-powering the keypad.
3. Release the enter button. The factory engineer's code is restored to 111111 (6 x 1).



# TIMECLOCK PROGRAMMING GUIDE

## Programming Art.701T (28G)

Programming is carried out by means of the four push buttons. The mode button advances through the modes beginning with mode 1 which allows the editing of the time and date, mode 2 – 7 allows the editing of the time bands and mode 8 allows the editing of the relay time in trade mode (*Note: mode 8 only appears in trade mode*). The up/down buttons allow the underlined information to be edited (*pressing these buttons once will change the value by one, holding the button down will auto increment the value until the button is released*) and the select button allows the underline cursor to rotate round to the next item on the display. If the time clock is inadvertently left in programming mode it will automatically revert to standby mode after a preset time.

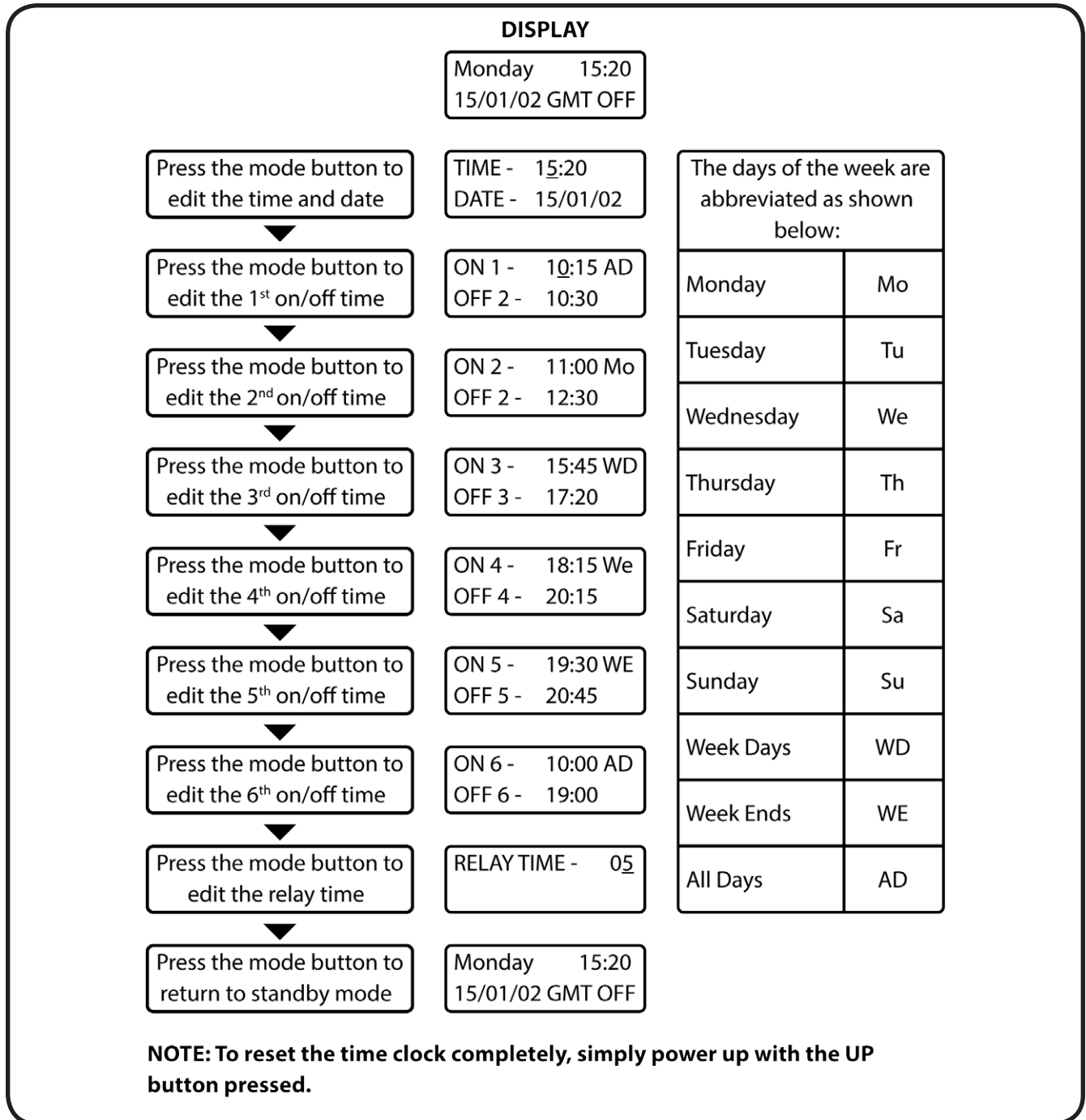

**NOTE:**

To reset the timeclock completely (*this will reset all programming options back to factory default settings*) simply power up the timeclock with the **UP** button pressed.

# WIRING DIAGRAMS

1 way audio system with codelock using a VR120/136-1/CL door panel connected to an Art.5118 apartment station and an Art.3112 audiophone.

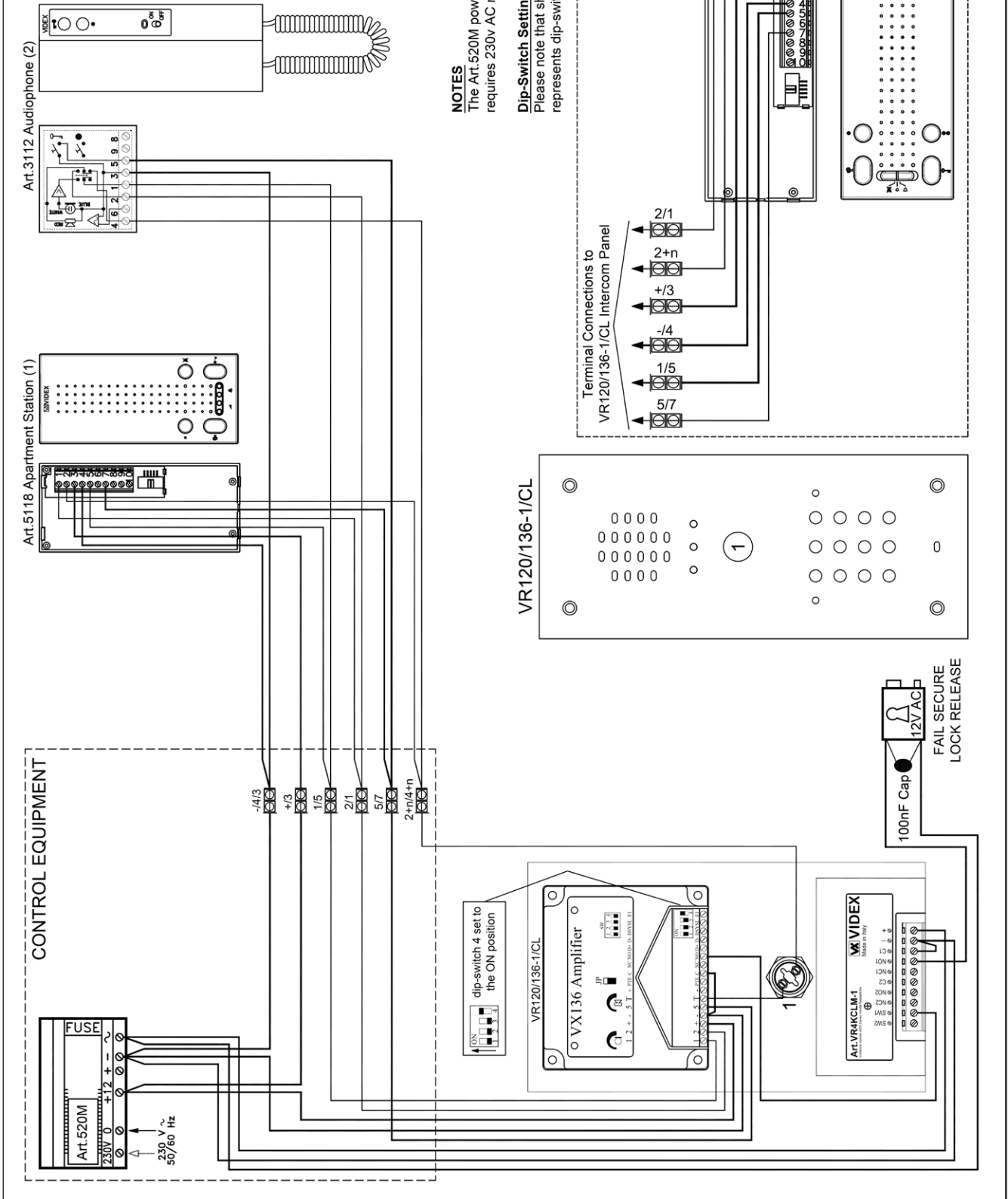

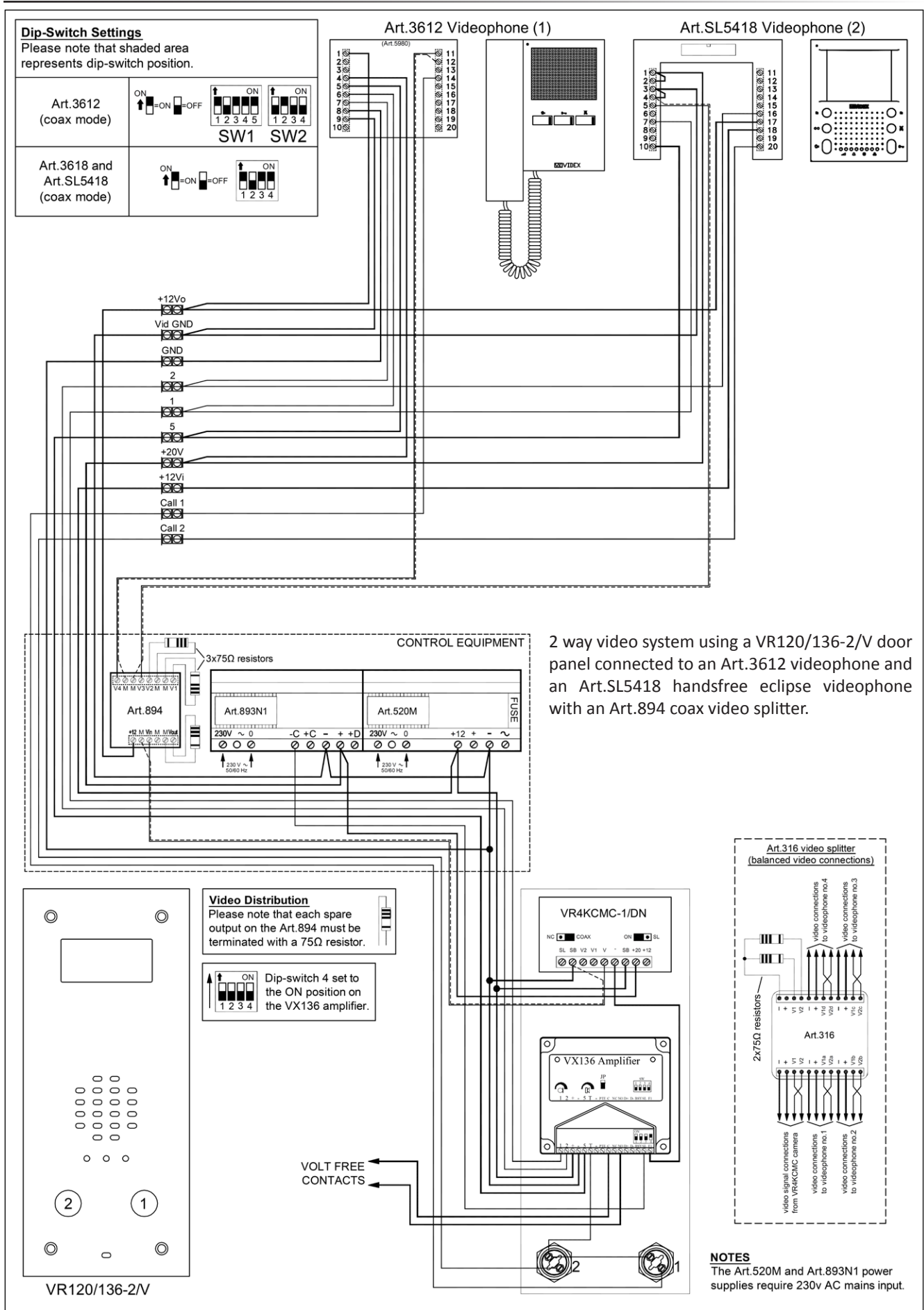

2 way video system using a VR120/136-2/V door panel connected to an Art.3612 videophone and an Art.SL5418 handsfree eclipse videophone with an Art.894 coax video splitter.

## TROUBLE SHOOTING

**W**hen trouble shooting on a large system it will be easier to break the system down to a manageable size. The simplest way to do this is to remove all but one handset. Doing this you can confirm the door panel and control equipment are free from faults. Once this has been confirmed you can reconnect the handsets in small sets (floor by floor) testing after each set to see if the fault has re-appeared.

### Audio and Video Systems

Symptom	Test
No speech from the door panel to the telephone (speech line 2).	<i>Check terminal 2 on the amplifier for continuity to terminal 2 on the telephone.</i>
	<i>During a call but before lifting the handset, check the voltage from terminal 2 of the 136 amplifier is 12Vdc. Trace this voltage to terminal 2 to the telephone.</i>
	<i>Check the voltage drops to approx. 1Vdc after the handset is lifted. (If not try another telephone).</i>
	<i>If all else fails try another 136 amplifier at the door station.</i>
No speech from the telephone to the door panel (speech line 1).	<i>Check terminal 1 on the 136 amplifier on the door panel for continuity back to terminal 1 on the telephone.</i>
	<i>During a call but before lifting the handset, check the voltage to on terminal 1 of the 136 amplifier is 12Vdc. Trace this voltage to terminal 1 to the telephone.</i>
	<i>Check the voltage drops to approx. 4Vdc after the handset is lifted. (If not try another telephone).</i>
	<i>If all else fails try another 136 amplifier at the door station.</i>
No speech in either direction.	<i>Check for 230v AC mains input to power supply (Art.520M, Art.520MR or Art.521B).</i>
	<i>If using an Art.520M or Art.520MR psu check the 315mA fuse in the power supply.</i>
	<i>Check for 12Vdc across terminals + &amp; - on the door panel 136 amplifier. This should be there all the time and comes directly from the PSU (Art.520M, Art.520MR or Art.521B).</i>
	<i>Check for continuity of both speech line cables, terminals 1 and 2 between the 136 amplifier to the audiophone or videophone.</i>
Lock will not operate from telephone.	<i>Check the door open LED comes ON when the lock button is pressed on the audiophone or videophone (only after speech is live to the handset).</i>
	<i>Check there is 12Vdc on the + and – terminals of the 136 door amplifier.</i>
	<i>Check for continuity across the 136 amplifier relay contacts C/NO when the lock button is pressed on the audiophone or videophone.</i>
	<i>Check for continuity across the 136 amplifier relay contacts C/NO when the PTE input has been triggered by a PTE button or by shorting out terminals PTE and – on the 136 amplifier.</i>
	<i>If using a fail secure lock release check for voltage across the lock when the lock button of the audiophone or videophone is pressed (only after speech is live to the handset) or when the PTE input is activated.</i>
	<i>If using a fail safe lock release check the voltage across the lock drops off when the lock button of the audiophone or videophone is pressed (only after speech is live to the handset) or when the PTE input is activated.</i>
Nothing happens when any call button is pressed.	<i>Check for continuity across the push button terminals.</i>
	<i>Check terminal T on the 136 amplifier for call tone voltage 10-12Vdc.</i>
	<i>Check the common of the buttons has 10-12Vdc present at all times.</i>



Symptom	Test
Nothing happens when any call button is pressed.	<i>Check for continuity on the call wire between the call button on the door panel to the call tone input terminal on the audiophone or videophone.</i>
Nothing happens when any call button is pressed (Audio Systems).	<i>On audio systems when a call button is pressed you should be able to read 10-12Vdc on terminals 3 &amp; 4 of the Art.3011/3111/3112 audiophones (4 of the audiophone comes direct from the call button). If using the Art.5112 or Art.5118 check for the same voltage reading on terminals 2 and 4(GND). Also check that the Art.5112 or the Art.5118 has 12Vdc on terminals 3 and 4(GND) at all times.</i>
Nothing happens when any call button is pressed (Video Systems).	<i>On video systems when a call button is pressed you should be able to read 10-12Vdc on terminals 8 and 14 of the Art.3612, if using the Art.3618 or the Art.SL5418 check for the same voltage on terminals 4(GND) and 20.</i>
Hum on the speech lines.	<i>Ensure all intercom cables do not run close to higher voltage cables i.e. mains cables. Try another 136 amplifier at the door panel.</i>
No video picture on videophone (red LED on but no picture).	<i>After a call is made check the Art.893N1 for 20Vdc on the + and – terminals and on the +D and – terminals. After a call is made check for 20Vdc on the +20 and – terminals on the VR4KCMC-1 camera, or if powering by +12V dc check for voltage on terminals +12 and – terminals. If switching the camera ON using the SL connection check the SL wire connection between the camera and the 136 amplifier. Check for a low signal across the SL and + terminals on the 136 amplifier during a call (the SL signal switches low so after a call the voltage reading across terminals SL and +12 should be 12Vdc). If using coax, check the Art.894 has 12Vdc on terminals +12 and M. Check coax cable is not broken or short. If using twisted pair (balanced signal), check the Art.316 has 20Vdc on terminals + and –(GND). Check twisted pair cable is not broken or short. If all else fails try a different Art.894 video splitter. If all else fails try a different Art.316 video splitter. If all else fails try a different Art.893N1 psu.</i>
Picture poor (coax).	<i>Check all end of line resistors are fitted to unused outputs on the Art.894 and a resistor is also fitted to the end of line. Check for any broken coax's or screens. Check the VR4KCMC-1 camera is set up for coax use. Check the videophone switch settings are set for coax use and end of line settings are applied correctly.</i>
Picture poor (balanced).	<i>Check end of line resistors are fitted to main end of line output V1 and –(GND) and on V2 and –(GND) on the Art.316. Check for any broken twisted pair connections for V1 and V2. Check the VR4KCMC-1 camera is set up for balanced use. Check the videophone switch settings are set for balanced use and end of line settings are applied correctly.</i>
No Camera recall.	<i>Check wire T is not broken between videophone and terminal T on the 136 amplifier.</i>





**Northern Office**

Videx Security Ltd.  
Unit 4-7 Chillingham Industrial Estate  
Newcastle Upon Tyne  
NE6 2XX

**Southern Office**

Videx Security Ltd.  
1 Osprey, Trinity Park  
Trinity Way' London  
E4 8TD



**TECHNICAL SUPPORT**

Tel: 0191 224 3174

Fax: 0191 224 4938

Email: [tech@videx-security.com](mailto:tech@videx-security.com)

Web: [www.videx-security.com](http://www.videx-security.com)