



# EASITAG

Setup Guide

Issue: 003



## 1 Legal and Copyright Notice

Entrotec regularly develop and enhance product lines, these changes will be included in the latest documentation. Whilst every effort has been made to ensure the accuracy of the information supplied herein, Entrotec cannot be held responsible for any errors or omissions. The materials contained in this document are protected and may be subject to intellectual property rights. Copyright 2016 by Entrotec Limited. All rights reserved.

## 2 Installation Specification

It is the responsibility of the installer to follow Entrotec's installation and cable specification as well as ALL relevant wiring regulations. Failure to comply with Entrotec's installation and cable specification may result in erratic operation of equipment and could invalidate any warranty.

Installations must comply with the following standards:

- BS 7671: Requirements for electrical installations. IET Wiring Regulations 17th Edition.
- BS EN 50133-1: Alarm systems. Access control systems for use in security applications. System requirements.
- BS EN 50133-2-1: Alarm systems. Access control systems for use in security applications. General requirements for components.
- BS EN 50133-7: Alarm systems. Access control systems for use in security applications. Application guidelines.
- BS 7807: Code of practice for design, installation and servicing of integrated systems incorporating fire detection and alarm systems and/or other security systems for buildings other than dwellings.

IET Wiring Regulations 17th Edition: Regulation 528-01 (Proximity to electrical services) imposes requirements for segregation of door entry / access control circuits (Band I), 230VAC mains circuits (Band II) and other higher voltage circuits.

IET Wiring Regulations 17th Edition: Regulations 542 to 543 impose requirements for earthing and bonding conductors. Ensure ALL metalwork is bonded to the buildings earth, this includes call panels, exit switches, cabinets and metal conduit. Ring terminals and earth points are provided on call panels and cabinets to terminate earth cables, ensure these connections are made.

## 3 Warranty and Support

Entrotec systems are renowned for their reliability and have a 2 year warranty on all Entrotec manufactured products as standard. This warranty does not cover water damage, vandalism, mains electrical faults, lightning strikes, damage caused by miswiring or cable faults.

Entrotec offer complimentary training courses and telephone support:

**0844 858 6370** (8:30am to 5pm Mon-Thurs and 8:30am to 4pm Friday – call charges may vary).

## Contents

<b>1</b>	<b>Legal and Copyright Notice .....</b>	<b>3</b>
<b>2</b>	<b>Installation Specification.....</b>	<b>3</b>
<b>3</b>	<b>Warranty and Support .....</b>	<b>3</b>
<b>4</b>	<b>Overview.....</b>	<b>5</b>
4.1	Proximity Reader and Call Panel .....	5
4.2	Programming Keys .....	5
<b>5</b>	<b>Programming.....</b>	<b>6</b>
5.1	Adding User Keys .....	6
5.2	Overwriting a User Key .....	7
5.3	Deleting a User Key.....	7
5.4	Adding / Editing Programming Keys – Apex and EasiTag Network Systems.....	8
5.5	Adding / Editing Programming Keys – Elite and EasiTag Single Systems .....	8
<b>6</b>	<b>Additional Options .....</b>	<b>9</b>
6.1	Apex Systems .....	9
6.1.1	Access Keys .....	10
6.1.2	Trades Keys .....	10
6.1.3	Local Keys.....	10
6.2	EasiTag Network Systems.....	10
6.3	Elite and EasiTag Single Systems .....	10

## 4 Overview

The EasiTag is an easy to use access control system that can be integrated in to door entry systems or available as a standalone option. EasiTag can store: 10 user keys per flat on Apex and EasiTag Network systems or 250 keys on Elite and EasiTag Single. Programming is fast and simple; the keys are securely administered at the call panel. On Apex and EasiTag network systems, key management is assisted with keys being assigned to a flat with a colour reference and can be done administered remotely.

### 4.1 Proximity Reader and Call Panel

Figure 1 shows a typical call panel with the EasiTag proximity reader.

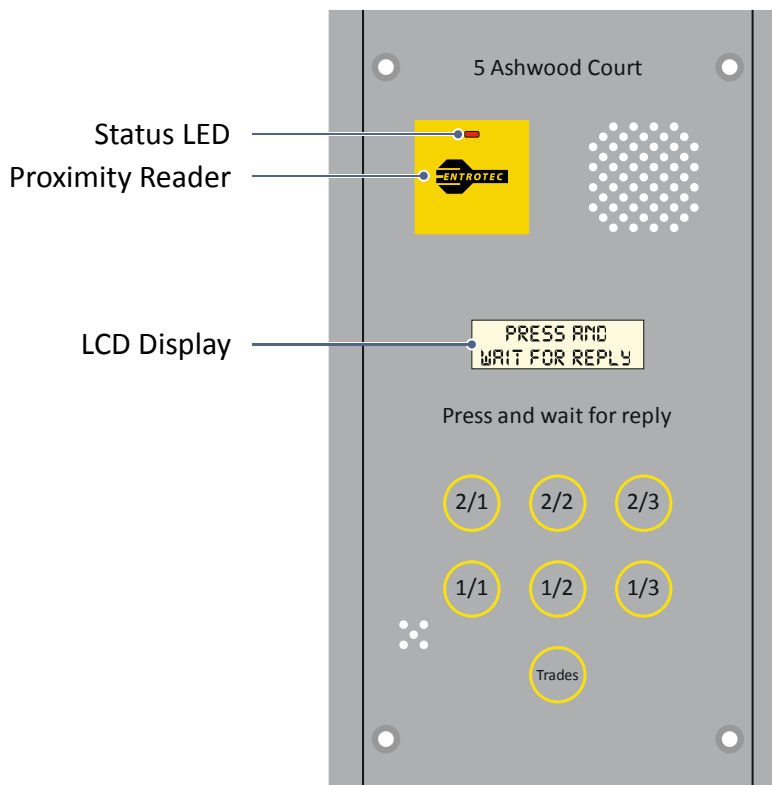

FIGURE 1

The multicolour status LED indicates reader / system status, see the table below (Figure 2).

LED colour	Status
Red	Idle / ready to read a key.
Amber	Key has been read and is being processed.
Green	Valid key has been read / door is open.
Flashing Red	Invalid key has been read / error.

FIGURE 2

### 4.2 Programming Keys

Each EasiTag system is provided with 1 or more programming keys (proximity card). This is unique to each system and allows access to all programming options. On customised systems, pre-programmed keys may have been pre-issued.

## 5 Programming

### 5.1 Adding User Keys

Present the programming key to the reader (Figure 3), holding the key at 45° provides the optimal read range. The status LED will turn amber to indicate the key has been read. Apex systems will then ask which flat the keys are to be assigned to (Figure 4).

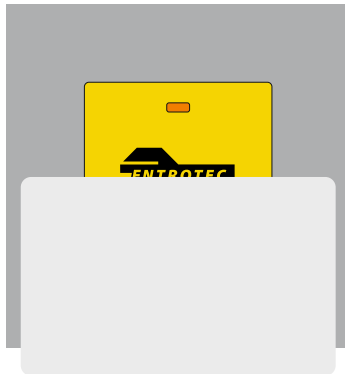

FIGURE 3

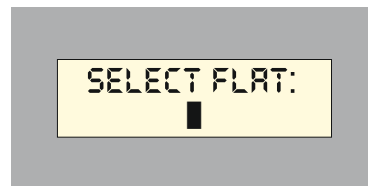

FIGURE 4

Apex and EasiTag Network systems only: Enter the desired flat number and then press 'Call' or '#'. On functional call panels - press the desired flat button.

The system will then find the 1<sup>st</sup> empty key slot at that flat, a string of 'FFFFFFFF' next to the slot number indicates that the slot is empty (Figure 5).



FIGURE 5

Present the new user key to the reader, the status LED will turn yellow and then green once the key is stored. The new key number will display at the slot (Figure 7), the system will jump to the next empty slot ready for the next key (repeat this step for each new user key).

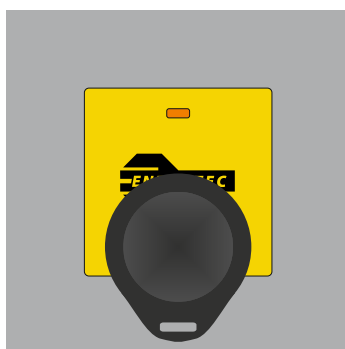

FIGURE 6

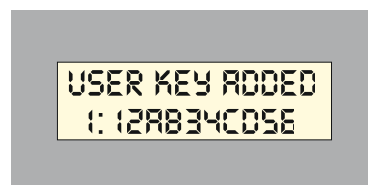

FIGURE 7

Once the keys are programmed for that flat, press 'Cancel' or \* once to select another flat or press twice to exit programming mode. The system will automatically time out of programming mode after 8 seconds of inactivity.

## 5.2 Overwriting a User Key

Enter the 'Add user key' menu as shown in section 5.1 and then present the programming key again to enter the 'Edit user key' menu. The LCD will display the 1<sup>st</sup> slot and the key number stored at that slot (Figure 8).

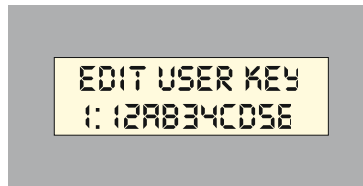

FIGURE 8

To edit a higher key slot, present the programming key to jump through the slots until the desired slot is reached. On keypads, the desired slot can be selected using the keypad.

Present the new user key to the reader (Figure 6), the status LED will turn yellow and then green once the key is stored. The new key number will display at the slot (Figure 7).

Once editing is complete, press 'Cancel' or \* twice to exit programming mode. The system will automatically time out of programming mode after 8 seconds of inactivity

## 5.3 Deleting a User Key

Enter the 'Add user key' menu as in section 5.1 and then present the programming key again to enter the 'Edit user key' menu. The LCD will display the 1<sup>st</sup> slot and the key number stored at that slot (Figure 8).

To delete a higher key slot, present the programming key to jump through the slots until the desired slot is reached.

With the desired key slot selected, after 8 seconds of inactivity the system will ask to delete the key (Figure 9).

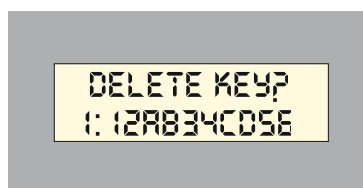

FIGURE 9

To confirm, present programming key to the reader. The LCD will confirm that the key has been deleted and the system will return to the 'Edit user key' menu, displaying the now empty key slot. To exit without deleting the key, allow the system to automatically time out of programming mode.

## 5.4 Adding / Editing Programming Keys – Apex and EasiTag Network Systems

To add or change a programming key, present the programming key to the reader (Figure 3). When the system is at the 'Select flat' menu (Figure 4), present the programming key again.

Use the buttons to navigate the menu to reach the 'Edit prog. key' menu (Figure 10). Present the programming key to the reader, the LCD will display the 1<sup>st</sup> key (Figure 11).



FIGURE 10



FIGURE 11

To add, overwrite or delete a higher key slot, use the buttons to reach the desired slot.

To add or overwrite, with the desired key slot selected, present the new programming key to the reader. The new key number will display at the slot (Figure 12).



FIGURE 12

To delete, with the desired key slot selected, after 8 seconds of inactivity the system will ask to delete the key. To confirm, present programming key to the reader. To exit without deleting the key, allow the system to automatically time out of programming mode. Be careful not to delete the wrong key.

**Note:** Programming keys are held locally at each door and are automatically synchronised when changes are made. A manual synchronisation is required when connecting new doors, perform the 'Sync prog. keys' function from a door that holds the existing programming keys (see section).

## 5.5 Adding / Editing Programming Keys – Elite and EasiTag Single Systems

To add or change a programming key, the entrance panel must be opened to allow access to the programming button on the display PCB.

Press the programming button repeatedly to scroll through the menu options until 'Edit prog. key' is displayed (Figure 13).



FIGURE 13

Present the programming key to the reader, the LCD will display the 1<sup>st</sup> key (Figure 3).





FIGURE 14

To add, overwrite or delete a higher key slot, press the programming button to jump through the slots until the desired slot is reached.

To add or overwrite, with the desired key slot selected, present the new programming key to the reader. The status LED will turn yellow and then green once the key is stored. The new key number will display at the slot (Figure 15).

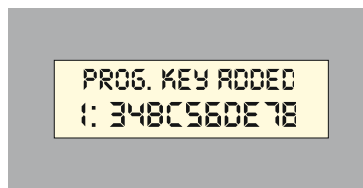

FIGURE 15

To delete, with the desired programming key slot selected, after 8 seconds of inactivity the system will ask to delete the key. Press the programming button again to confirm. To exit without deleting the key, allow the system to automatically time out of programming mode. Be careful not to delete the wrong key.

## 6 Additional Options

### 6.1 Apex Systems

To enter the options menu, present the programming key to the reader twice. Figure 16 summarises the options menu. The call panel buttons are used to navigate through the options menu. To enter or confirm various options, present the programming key. On digital call panels, press 'Call' to enter or confirm and 'Cancel' to cancel or exit.

Menu	Option	Function
1	Test reader	Displays the key ID of any key presented at the reader.
2	Find key	Displays the location and ID of key presented at the reader (if stored).
3	Edit prog. key	Allows programming keys to be added, over written and deleted.
4	Sync prog. keys	Forces synchronisation of programming keys.
5	Batch delete	Allows user keys to be batch deleted flat by flat.
6	Edit access key	Allows access keys to be added, over written and deleted.
7	Sync access keys	Forces synchronisation of access keys.
8	Edit trades key	Allows trades keys to be added, over written and deleted.
9	Sync trades keys	Forces synchronisation of trades keys.
10	Edit local key	Allows local keys to be added, over written and deleted.

FIGURE 16

### 6.1.1 Access Keys

There are 100 access key slots on the system. Access keys provide 24hr access to each entrance on are automatically synchronised across the system. These are not assigned to a flat number, so are suitable for staff access, etc.

### 6.1.2 Trades Keys

There are 100 trades key slots on the system. Trades keys provide times access to each entrance on the system and are only active during pre-set trades times. Trades keys automatically synchronised across the system and are not assigned to a flat number, so are suitable for postal and delivery access, etc.

### 6.1.3 Local Keys

There are 100 local key slots on each entrance. Local keys provide 24hr access to each entrance on they are programmed to. These are not assigned to a flat number, so are suitable for staff access, etc.

## 6.2 EasiTag Network Systems

To enter the options menu, present the programming key to the reader twice. Figure 17 summarises the options menu. The buttons are used to navigate through the options menu. To enter or confirm various options, present the programming key or press # to enter or confirm and \* to cancel or exit.

Menu	Option	Function
1	Test reader	Displays the key ID of any key presented at the reader.
2	Find key	Displays the location and ID of key presented at the reader (if stored).
3	Edit prog. key	Allows programming keys to be added, over written and deleted.
4	Sync prog. keys	Forces synchronisation of programming keys.
5	Batch delete	Allows user keys to be batch deleted flat by flat.

FIGURE 17

## 6.3 Elite and EasiTag Single Systems

The programming button (SW1) on the display PCB can be used to scroll through the options menu. Figure 18 summarises these options. To enter or confirm various options, present the programming key.

Menu	Option	Function
1	Key usage	Displays the user key memory usage.
2	Last used key	Displays the last user key that opened the door.
3	Test reader	Displays the key ID of any key presented at the reader.
4	Find key	Displays the location and ID of key presented at the reader (if stored).
5	Edit prog. key	Allows programming keys to be added, over written and deleted.
6	Mode	Switches mode of operation, factory set.
7	Edit lock time	Standalone units only – Adjusts lock release time.

FIGURE 18





Entrotec Ltd  
5 Ashwood Court  
Oakbank  
Livingston EH53 0TL

Telephone: 01506 886 230  
Support: 0844 858 6370

[www.entrotec.com](http://www.entrotec.com)



Manufactured in the UK