

AUTOMATION CATALOGUE  
**2024**

Gates automation, garage doors automation  
and industrial closures. Automatic barriers.



**CAME** 

# GENERAL INDEX AND LEGEND OF SYMBOLS



News



This operator is tested in conformity with EUROPEAN STANDARDS on impact forces



Gearmotor or operator with ENCODER



The 24 or 36 V DC gearmotors are designed for INTENSIVE DUTY and are guaranteed to work even during power outages. This icon also means that a product is powered by low voltage.



This product is designed to fit the RIO System 2.0-series, 806SS-0040 snap-in card.



The 230 – 400 V AC TRI-PHASE versions are ideal for INDUSTRIAL use as they guarantee greater gearmotor starting thrust



This product features BRUSHLESS technology



This CORDLESS product is battery-powered and wireless



Product compatible with 2-wire connection technology CXN BUS



This WIRELESS product is battery-powered and operates with radio technology



Developed with CONNECT technology for remote digital control via gateway or locally via CAME KEY

2	GENERAL INDEX AND LEGEND OF SYMBOLS
4	A new way of thinking, a new way of doing
5	Vision & Mission
6	Forever innovators
8	The offer
18	Our worldwide network
20	Training that makes a difference
22	CAME CONNECT
24	CAME KEY
26	NEWS
40	European Standards
41	Safety



## 42 SLIDING GATE AUTOMATION

44	SELECTION GUIDE
46	STANDARD INSTALLATION
48	BXL
50	BXV
54	BX
56	BK
60	BKV
64	BY-3500T
67	CONTROL BOARD FUNCTIONS



## 68 SWING GATE AUTOMATION

70	SELECTION GUIDE
72	STANDARD INSTALLATION
76	ATS
80	AXL
82	AXI
84	AXO
86	ATI
88	KRONO
90	STYLO
92	FTL
94	FTX
98	FAST 70
102	FERNI
104	FROG
108	FROG PLUS
110	SUPER FROG
113	CONTROL BOARD FUNCTIONS



## 114 GARAGE DOOR AUTOMATION

116	SELECTION GUIDE
118	STANDARD INSTALLATION
122	VER PLUS
124	VER
126	EMEGA
129	CONTROL BOARD FUNCTIONS



## 130 AUTOMATIC BARRIERS

132	SELECTION GUIDE
135	STANDARD INSTALLATION
140	GARD LT4
144	GARD LS4
150	GARD GT4
156	GARD PX
160	GARD 5000
162	GARD
168	GARD GT8
174	GARD 12
176	UNIPARK
178	CAT
180	CONTROL BOARD FUNCTIONS



## 182 INDUSTRIAL DOOR AUTOMATION

184	SELECTION GUIDE
186	STANDARD INSTALLATION
190	F4000
192	CBX
196	H4
199	CONTROL BOARD FUNCTIONS



## 200 CONTROL AND SAFETY ACCESSORIES

202	Selection guide
	<b>TRANSMITTERS</b>
212	TTS
214	TOP
	<b>PHOTOCELLS</b>
218	DXR
220	DLX
222	DIR
	<b>FLASHING LIGHTS</b>
224	KLT
226	KRX
228	KIARO
	<b>SELECTORS</b>
230	SEL Key
232	SEL Digital
	<b>RECEIVERS</b>
236	RBE-RE
	<b>GATEWAYS</b>
240	GATEWAY
	<b>SAFETY</b>
242	DFWN
244	EDG
248	RIO System 2.0
	<b>ACCESS CAME CONNECT</b>
250	Quick&Easy Access

## 254 ANALYTICAL INDEX

# A NEW WAY OF THINKING, A NEW WAY OF DOING

If we think differently, we act differently, in a way that simplifies the lives of people and improves the work of professionals, creating skills and investing in research generating global solutions.

We help our end customers by providing them with safe, efficient and convenient solutions to improve the quality of their living spaces, whether private or public.

We do this thanks to the know-how and expertise of our global network; we are a global benchmark for automation, smart homes, access control and security, and parking systems.



# VISION

We believe in a world where sustainable technological innovation makes people's lives more comfortable, simple and secure

# MIS SION

To create a global offer of high-quality technological products and solutions for automation, smart homes, access control and security to improve our customers lives and our partners business

# FOREVER INNOVATORS

For over 50 years, we at CAME have designed and produced high-quality technological products and solutions for the comfort and security of people in residential, public and business environments.

Thanks to the trust of our customers, we have become a go-to brand and global partner for automation, smart homes, access control and security, and parking systems.

We have capitalised on our experience and built quality relationships with many professionals, who have become ambassadors of CAME's values, bringing cutting edge technology into the lives of our customers around the world.

Our innovations translated into solutions for people become strategic for defining the scenarios of planning and living the future.



## RESIDENTIAL SOLUTIONS



We have gone on to develop an idea of home automation that is increasingly integrated and connected with people's lives. Today, automation is at the heart of the home, managing entrances and garage doors, controlling blinds and shutters, video entry systems and climate control.



## BUSINESS SOLUTIONS



For every public area, we offer the most sophisticated systems for pedestrian and vehicle access control and security, video entry systems and parking solutions. Small and large companies, commercial enterprises, large buildings: CAME-branded automation provide control and safety in both small and large working environments.

## URBAN SOLUTIONS



The complexity involved in living spaces and in mobility flows require ever greater protection and security, plus enhanced reactive capacity and greater know-how. Our offer is geared to meet the different automation needs for urban planning and architectural scenarios. CAME solutions are engineered for managing safety and control in large works and for contributing to the planning of urban spaces making them "Safe and Smart", as called for in today's fast-paced, metropolitan centres.



# AUTOMATION

Our market experience enables us to provide a complete, state-of-the-art range of automation for gates, garage doors, industrial sectional doors and automatic barriers. The Connect technology fitted into these operators lets you manage all features in remote mode. This is quite an advantage for both end users and installers, who can provide assistance also remotely.

Safety, design and innovation are the hallmark of all our products, which are designed to be integrated into any type of building.





## **AUTOMATION FOR SWING AND SLIDING GATES**

CAME's wide range of automation solutions makes it possible to make all types of entrances smart and secure, while ensuring maximum reliability at all times.



## **AUTOMATIC BARRIERS**

CAME barriers for vehicle access control can be used in residential, industrial and urban contexts. Thanks to Made in Italy quality and constant investment in research and development, our barriers offer a high level of performance to ensure maximum efficiency of service in all contexts, including intensive use.



## **AUTOMATION FOR GARAGE DOORS AND INDUSTRIAL DOORS**

Our highest aesthetic, technological and quality standards make it possible to integrate garage doors and industrial sectional doors with the most modern residential architecture.

# SMART HOME

Today homes are increasingly connected to people, their needs and lifestyles. Smart technologies are capable of automating a number of activities in order to provide greater comfort and convenience. QBE by CAME is the wireless solution that interacts with awnings, shutters, lights, home climate control,

and all home automation devices. All these devices can be managed remotely, directly on smartphones and tablets or by voice commands, thus creating a true home automation system for an increasingly smart home.





## VIDEO ENTRY SYSTEMS

Our range of video entry systems features an exclusive design and an innovative technology, combining advanced performance with the maximum ease of installation and use. We offer a wide range of entry panels, video and audio receivers designed to meet every need and offer advanced features, such as the ability to answer the door calls directly from your smartphone even when you are away from home.



## CLIMATE CONTROL

We offer a broad range of thermostats and chronothermostats that are suited for any type of installation thanks to their reliability, user-friendliness and design, to offer maximum convenience and save energy.



## AUTOMATION SOLUTIONS FOR AWNINGS AND SHUTTERS

We have devised a wide range of automation solutions for awnings, shutters and blinds, all cutting-edge and ideal for residential, business and industrial settings.

# ACCESS CONTROL

Our experience, competency, and innovation drive us to provide world-class, cutting-edge solutions for controlling busy access points, exposition and urban venues.

We offer access control solutions with a sophisticated design, but above all open to the integration with third-party technologies.

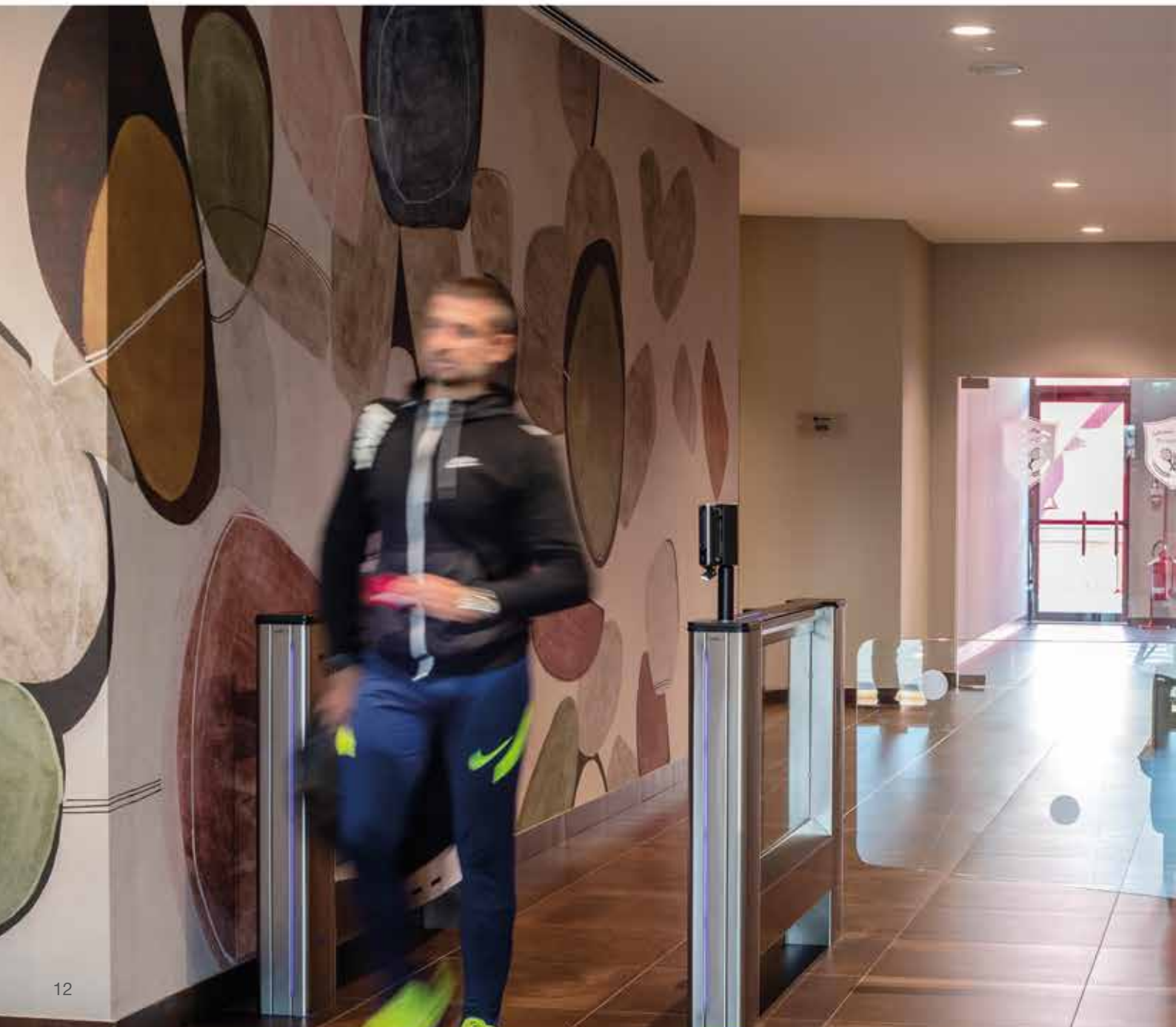



## SPEED GATES

The compact design and fast opening speed make speed gates the ideal solution for settings where the flow of people is high and security must be provided efficiently. They are used in crowded places such as train stations, airports, shopping malls and entertainment venues and can be integrated with biometric recognition systems, smart cards or QR codes, providing an additional level of security.



## FULL-HEIGHT TURNSTILES

Full-height turnstiles are the ideal solution to ensure pedestrian access control and maximum security for the places and people inside them. They are suitable for facilities such as stadiums, airports, stations, sports facilities or governmental offices.



## ACCESS CONTROL SYSTEM

CAME offers solutions for the management of both pedestrian and vehicle access points combining ease and versatility of use. These flexible systems make it possible to control both a single gateway and a multiaccess system, ensuring that up to 10,000 users can be managed at each site.

# SAFETY

Managing sustainable mobility and urban traffic control are issues that concern us all. Since the first bollard was invented, we have striven to make urban spaces safe and smart, transforming them into reliable and safe places.

Our innovations aim to redefine urban mobility with high-tech solutions, designed for the security of sensitive areas and the control of restricted traffic zones.





## BOLLARDS

Automatic bollards are used to prevent vehicles from parking in private areas or in areas where parking is not allowed or to prevent access to restricted traffic zones. They can also be used to provide security in places at risk of break-ins by ram vehicles. CAME's offerings include various types of bollards depending on the use and the level of protection required.

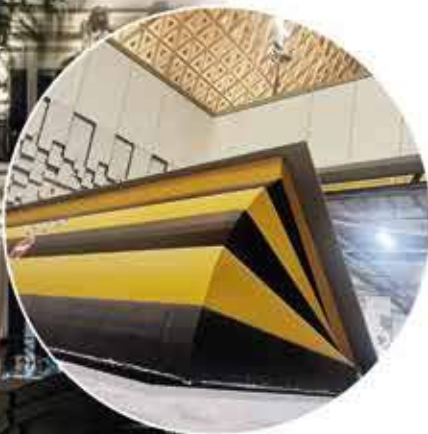

## ROAD BLOCKERS

CAME road blockers are hydraulic devices made of high-strength steel, which are also available in a lowprofile version to limit the depth of the underground installation space and facilitate installation even in the presence of cables and pipes. The number of our international certifications received after brilliantly passing rigorous crash tests testify to CAME's commitment to security.



## MANAGEMENT SOFTWARE

CAME software, with open protocols such as Modbus, ONVIF, Web Service, is perfectly integrated with the most modern technologies for intelligent city management.

# PARKING SYSTEMS

Our decades-old experience allows us to offer cutting-edge, high-tech solutions for controlling urban spaces and parking facilities in public areas according to the principles and needs of any Smart City.

CAME anticipates customer needs, responding with innovative software solutions and a wide range of offstreet products and services.

We challenge ourselves every day with the quality of our solutions to simplify and increase the efficiency of parking facilities by improving profitability, control and performance.





## ZERO KM SERVICE

Zero KM Service, the new service concept for parkings, is a revolution in the world of parking, improving the performance of systems, guaranteeing the operator full autonomy in the maintenance service.



## MANAGEMENT SOFTWARE

Lince is CAME's universal parking management software. It is flexible and highly customisable and combines all the functions of parking management, monitoring and payment services, including integration with products and services offered by third parties.

# OUR WORLDWIDE NETWORK

## BRANCHES AMERICA

Brazil  
Chile  
Mexico  
Perù  
USA  
Canada

CAME is a technological partner for those projects that require integrated systems for improving the quality of our living spaces, whether private or public, with products designed for controlling the home, managing urban and business environments.

We are a worldwide network. From our Treviso Headquarters, the heart of the Group, we coordinate **10 manufacturing plants** and **4 R&D centres**. We have more than **25 subsidiaries** and **40 warehouses worldwide**.

Thanks to our commercial partners and distributors, **we operate in more than 110 countries** with an integrated and global vision.

Our Group shares common goals, which go well beyond our respective specializations: thanks to the synergies that exist among all the divisions and brands, we share a modus operandi that enriches our diversity.

CAME 

CAME  URBACO

CAME  BPT

CAME  PARKARE

CAME  ÖZAK

CAME  KMS

CAME  NEPOS

CAME  ENTROTEC

298

2022 TURNOVER  
(MLN EUROS)

10

PRODUCTION  
PLANTS

4

R&D CENTRES

+25

DIRECT  
BRANCHES

+110

COUNTRIES WITH  
PARTNERS AND  
DISTRIBUTORS

+40

WAREHOUSES IN  
THE WORLD

## BRANCHES EUROPE

Italy	Poland
Belgium	Portugal
Croatia	Russia
France	Spain
Germany	UK
Ireland	Turkey
Netherlands	

## CAME HEADQUARTERS

Treviso, Italy

## BRANCHES ASIA

United Arab Emirates

India

China

# TRAINING THAT MAKES A DIFFERENCE.



## TRAINING LAB

Professionals have a tough job, which always requires upgrading and updating.

Technical and product developments are not the only issues; the keys to success are a deep regulations knowledge and a strong relationship with customers, that are always more demanding for efficient services.

TRAINING LAB is the online platform dedicated to all professionals who would like to keep up-to-date with new CAME technologies in a simple and convenient way.

It is designed to enhance the experience of CAME technicians around the world and is available in several languages.

A unique tool to enhance professional skills, always available through in-person courses, online webinars and e-learning programs.

Sign up and see the list of available courses:  
<https://traininglab.came.com/global>

## A TEAM OF PROS

CAME offers to installers its own team of trainers, composed by technicians specialized in each product lines. All the trainers are internal staff members with great know-how and experience on projects, sales and technical issues. Each course provides the attending professionals with all is necessary for their job, so they can stay abreast of the latest market developments.

TRAINING COURSES.

INVESTING IN YOUR STAFF  
BUILDING YOUR BUSINESS

## CAME TRAINING TEAM



### FOR INFORMATION AND REGISTRATION:

Upon request, CAME will design and deliver courses, tailored around your needs, by setting up the learning path, course schedule and locations.

The training program also continues online, thanks to the webinar formula for in-depth analysis of all CAME topics.

A complete and constantly updated calendar, with schedules compatible with the work of our partners and automation professionals, to offer continuous and tailor-made updating solutions.



Send your request to  
[traininginternational@came.com](mailto:traininginternational@came.com)



Call for more information at  
+39 0422 15 69 511 during  
business hours.

Sign up and see the list of available  
courses:  
<https://traininglab.came.com/global>



# CONNECT



**INSTALLER**  
Configuration  
Access  
Monitoring  
Maintenance



**ADMINISTRATOR**  
Users management  
Monitoring  
Maintenance requests



**CLIENTE**  
Access

CONNECT is the CAME technology that allows to manage operators that improve the quality of life. The operators connected over the Internet offer added value for the user and open up new horizons for the installer's business.

Presented in 2015 and used by thousands of installers worldwide, CONNECT is now even more practical, more performing and more secure.

CAME has chosen to develop internally the technologies necessary to manage data flow and protection. No external agency processes the information, no server is located in remote locations around the world.

An innovative technological heart, to ensure high security and reliability. CAME has invested in research and development with the aim of simplifying the installer's work, improving user experience and offering new digital services.



All products marked by the new blue icon use **CONNECT** technology. They are designed for local and remote digital control and make all advanced services available through the Internet connection.

## CONNECT MEANS

**INTERNET**  
connection via CAME gateways

**COMPATIBILITY**  
with new quick-coupling gateways

**CONFIGURATION**  
and setup from smartphone  
with KEY CAME

**REMOTE CONTROL**  
for the user through Apps



## CONNECT TO THE INSTALLER'S SERVICE

Connected operators can be managed remotely via PC or smartphone. The CONNECT platform enables automatic programming via QR code of the radio controls, their remote insertion or deletion, without having to be near the operator. A portal is also available for the management of customers and installed systems and scheduled maintenance, for monitoring the status of devices with receipt of notifications in real time.

CONNECT allows the installer to offer a complete 24/7 service becoming the trusted partner for his customer.



**PC PLATFORM**  
came.com/connect



**SMARTPHONE APPS**  
Connect SetUp



## CONNECT TO THE ADMINISTRATOR SERVICE

Essential for the condominium administrator, building manager or the system owner, the CONNECT platform allows to enable the accesses and program the remote controls.

The system administrator can also monitor the operator status and receive notifications in the event of malfunctions, if any.

It can send on-site service requests to the installer or enable remote diagnosis.



**PC PLATFORM**  
came.com/connect



**SMARTPHONE APPS**  
Connect SetUp



## CONNECT TO CUSTOMER SERVICE

Through the free Apps that can be installed on any Android or iOS smartphone, the user can control the devices remotely.

The App Automation allows to control all connected operations with a single smartphone, through simple and intuitive commands.

Thanks to the geolocation function, it also allows to set the automatic opening and closing, based on a customizable proximity radius.



## HOW CONNECT WORKS

To enable CONNECT services, each automation must be equipped with a GATEWAY or SLAVE module for radio connection.

Besides the plug-in GATEWAYS that use Wi-Fi technology, CAME also offers a practical GSM GATEWAY which guarantees the most complete autonomy of operation thanks to the mobile phone connection.



# CAME KEY FOR AN EVEN SIMPLER INSTALLATION

CAME KEY is the new working tool designed to streamline installation, programming and management of automated operators.

By exploiting the WiFi communication between CAME KEY and smartphones, the device serves as an interface between the control board and the CONNECT SetUp APP, allowing you to access the control panel functions to adjust the system's parameters.

CAME KEY reduces job times when operators are installed in hard-to-get places, and, allows installers to do the all of the following:

- Update firmware on the control board for new features.
- Manage all operator parameters, which are organized by type.
- Check maneuvers for scheduled maintenance.
- Duplicate radio-frequency controls via QR code.



CAME KEY is compatible with all products marked with this symbol:

Download the CONNECT SetUp app from:





**WI-FI INTERFACE TO SET UP  
OPERATORS**

**806SA-0110**

## **THE BENEFITS**

- Compatible with all control boards that are CAME Connect compatible.
- Guided set up for quick and simple commissioning.
- Backup settings to the CAME Connect cloud.
- Auto-detection of the control board.
- Settings and operators are organized by customer.
- Easy settings, thanks to the app's clear, intuitive graphical interface.



AUTOMATIC BARRIERS

NEWS  
N

# GARD LT4



# QUALITY AT THE BEST VALUE

GARD LT4 is the automatic barrier for passage widths from 2.5 to 4 meters that combines CAME's usual reliability with excellent commercial value.

Designed to offer an MCBF value of 1.5 million cycles, GARD LT4 is tested for a usage frequency of 300 cycles/hour.

In addition to the 24V DC motor that ensures smooth boom movement and rapid operations (up to 2 seconds), GARD LT4 is equipped with **ADVANCED SPEED CONTROL**, the innovative feature that constantly monitors the forces exerted on the boom to ensure constant speed in all weather conditions.

It is also the ideal solution for settings where integration with other CAME systems is required through **CONNECT** technology, or with third-party systems, because of its compatibility with the **MODBUS** protocol. GARD LT4 is equipped with a single spring that makes boom balancing operations easy and is configurable with all CAME control and safety accessories as well as specific devices such as folding skirts.

## MAIN CHARACTERISTICS

- 4 Models with different finishes including RAL color on request.
- 2 types of boom, 60 x 40 mm rectangular section and 60 mm diameter round section.
- **EASY START UP** through a dedicated intermediate plate that allows the installer to easily reverse the opening direction, even after having already installed the barrier, without the need to disassemble the various components.
- **ZL392-C** control board equipped with configurable inputs, LED strip output, connectors for keyboards or RFID reader, memory roll for saving configurations, and serial ports for managing coupled barriers.
- Battery system for operation in case of power failure.

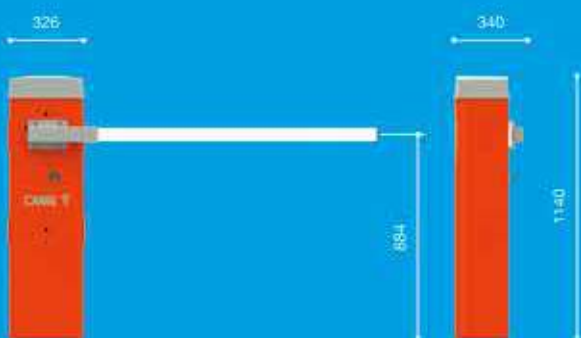

Emergency batteries



Rectangular boom

Boom with skirt





AUTOMATIC BARRIERS

NEWS  
N

# GARD LS4



# PERFORMANCE MEETS DESIGN

GARD LS4 is the automatic barrier for passage widths from 2.5 to 3.8 meters specifically for settings where the greatest aesthetic impact is also required. Designed to offer an MCBF value of 1.5 million cycles, GARD LS4 is tested for the usage frequency of 300 cycles/hour.

In addition to the 24V DC motor that ensures smooth boom movement and rapid operations (up to 2 seconds), GARD LS4 is equipped with **ADVANCED SPEED CONTROL**, the innovative feature that constantly monitors the forces exerted on the boom to ensure constant speed in all weather conditions.

It is also the ideal solution for settings where integration with other CAME systems is required through **CONNECT** technology, or with third-party systems, because of its compatibility with the **MODBUS** protocol.

GARD LS4 is equipped with a single spring that makes boom balancing operations easy and is configurable with all CAME control and safety accessories as well as specific devices such as folding skirts.

## MAIN CHARACTERISTICS

- 4 Models with different finishes including RAL color on request.
- 2 types of boom, 90 x 35 mm profiled and 60 mm diameter round section.
- Boom release mechanism in case of impact.
- System for jointed boom.
- Skirt.
- Optional dedicated flashing light.
- Heater kit with thermostat.
- **EASY START UP** through a dedicated intermediate plate that allows the installer to easily reverse the opening direction, even after having already installed the barrier, without the need to disassemble the various components.
- ZL392-C control board equipped with configurable inputs, LED strip output, connectors for keyboards or RFID reader, memory roll for saving configurations, and serial ports for managing coupled barriers.
- Battery system for operation in case of power failure.

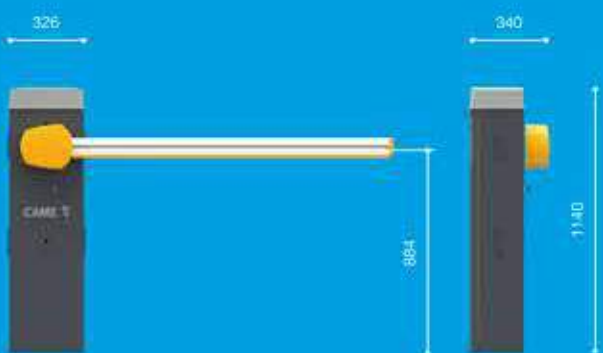

KLT Flashing light



Emergency batteries



Boom release device

Jointed boom





AUTOMATIC BARRIERS

NEWS

# GARD GT4



# THE NEW BENCHMARK FOR AUTOMATIC BARRIERS

GARD GT4 is suitable for passageways up to 5 meters.

The cabinet, with its elegant and functional design, is extremely durable and is prepared for the integration of control and safety accessories.

High-visibility LED lights on the crown and on both sides of the boom act as traffic lights with red and green signals to facilitate passages.

The accessories include the newly developed SAFETY BOOM RELEASE SYSTEM and the new FOLDING SHIRT AT ALL HEIGHTS.

**RELIABLE:**

24 V DC motor with encoder and ADVANCED SPEED CONTROL.

**INTEGRATION:**

digital inputs, CXN BUS inputs, MODBUS and CONNECT protocol.

**PRACTICAL:**

single spring balancing system already included.

**SAFE:**

shockproof rubber profile and obstacle detection, compliant with EN-12453.

**FAST:**

4 seconds.

**GARD GT4 - MCBF 3 MILLION CYCLES:**

tested for intensive use up to 300 cycles/hour.





# KLT



# FLASHING LIGHT FOR BARRIERS AND GARAGE DOORS

KLT is the perfect solution for applications on GARD LT4 and GARD LS4 automatic barriers, but also on modern garage doors.

The simple connection and the possibility of customizing colors and flashing type, allow the installer to choose the best signaling configuration for each specific context.

KLT is also the perfect solution for any setting where the application of a slim flashing light with essential lines is required. Installed on a wall or post, KLT is in fact ideal in conjunction with garage door automations, industrial doors or gates.

Here are some features:

## DOUBLE FREQUENCY

KLT has a built-in dual-frequency antenna and is therefore compatible with all CAME radio transmitters with 433 MHz and 868 MHz frequencies.

## QUALITY OF MATERIALS

KLT is designed using high-quality polycarbonate and thus guarantees strength and durability.

## OPERATING MODES

KLT has advanced electronics that allow customisation of light colour and flashing, to meet the needs of any user.

## COURTESY LIGHT

KLT also implements the very useful COURTESY LIGHT function: the user can easily set the time for which the white light remains on after completing the operation.

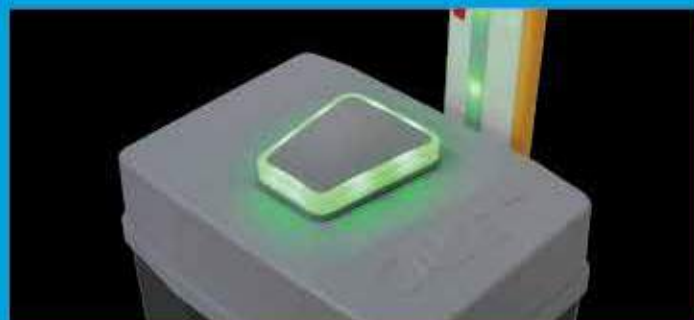
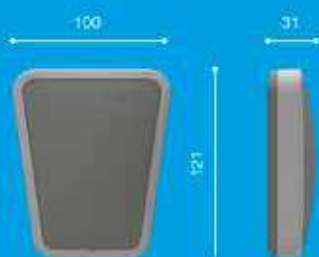



ACCESS CONTROL

NEWS  
N

# QUICK&EASY ACCESS



# THE TEMPORARY ACCESS SOLUTION THAT ALLOWS YOU TO EXPAND YOUR BUSINESS

QUICK&EASY ACCESS is the solution that meets the needs of many types of facilities allowing you to manage, without the need for dedicated staff, access to facilities such as:



B&B



SMALL HOTELS



CAMPINGS



PRIVATE PARKING SPACES



WAREHOUSES

The guest can log in using a smartphone or by typing a code on a keypad, depending on the needs and characteristics of the facility.

The facility manager can set access times and modes, send customised e-mails and confirmations, manage keypad codes for opening doors in common areas via the cloud, open gates through the app, and obtain automated backups.

The benefits for visitors who need to access a location managed through Quick&Easy Access include the simplicity with which they obtain instructions and codes for access, and the fact that they do not have to be subject to any particular time constraints.

In addition, the CAME system uses a simple Web portal accessible via an Internet connection and therefore does not require the installation of any App: in this way the user does not have to configure any application or create an account, but simply click on the link sent by the facility manager.



Module  
806RV-0020



Slave module  
806SA-0150



Gateway  
806SA-0180



Keypad selector  
806SL-0280



**8K06RV-006**  
NEW QUICK & EASY ACCESS WI-FI KIT

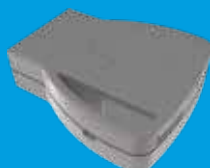

Wi-Fi Gateway  
806SA-0200





# TOP

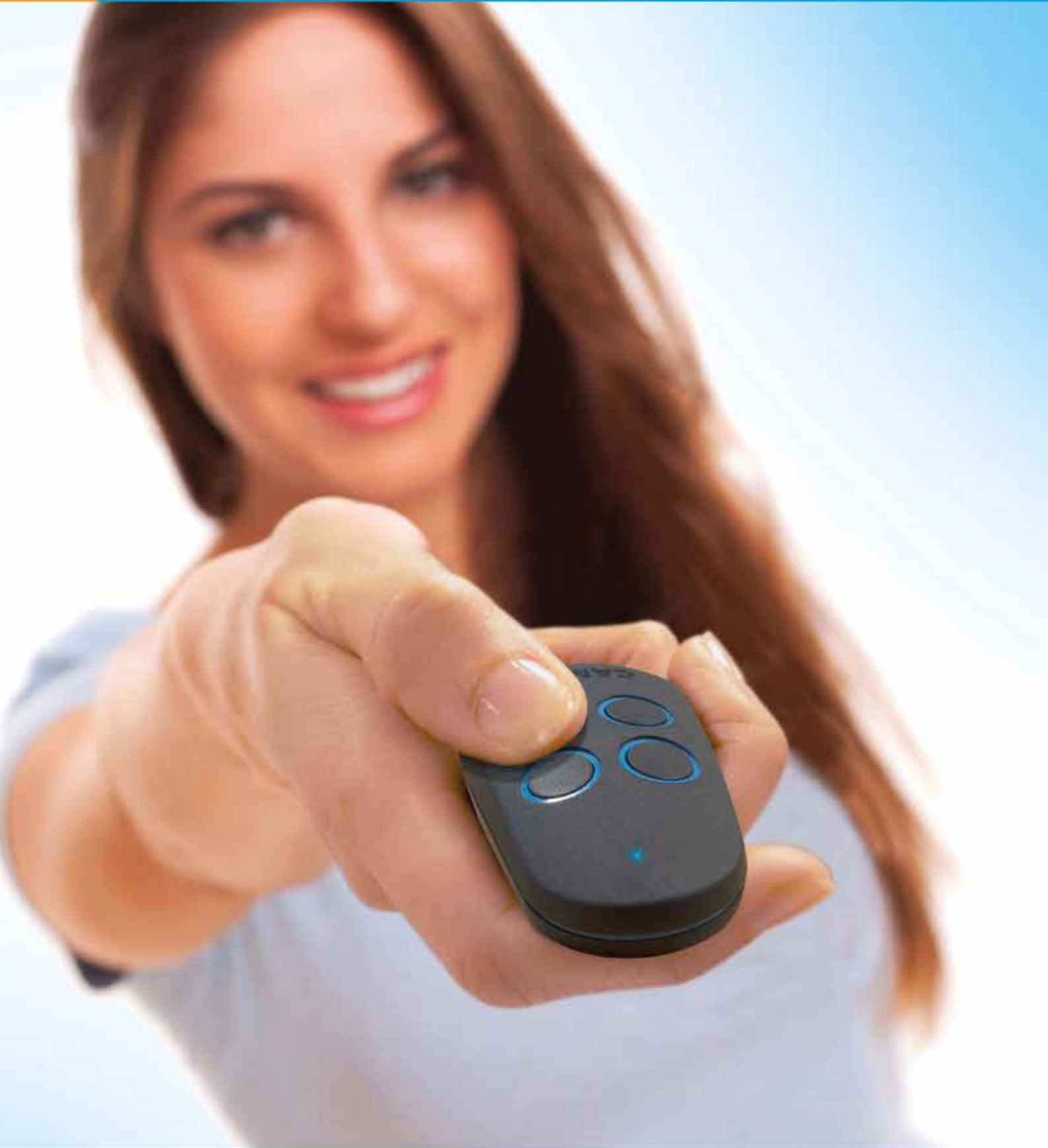

# THE CAME REMOTE CONTROL

TOP is the evolution of the CAME radio control, available in different versions to allow the most complete flexibility and meet all market requirements. Its ergonomic shape and high quality materials guarantee a durable and reliable product in all conditions.

TOP is available with 2 or 4 channels, and with ROLLING CODE or FIXED CODE technology.



## **LIGHT BLUE TOP - ROLLING CODE 433.92 MHZ**

It eliminates the risk of cloning the radio control and allows the installer or system operator to control the users.

4 buttons: TOP44RBN - 806TS-0270



## **GREEN TOP - ROLLING CODE 433.92 - 868.35 MHZ**

Dual frequency technology is the ideal solution for situations where interference with other devices may occur. The TOP radio control can transmit at either 433.92 MHz or 868.35 MHz according to the system specifications.

4 buttons: TOPD4REN - 806TS-0290



## **BLACK TOP - FIXED CODE 433.92 MHZ**

It ensures maximum flexibility of use and easy duplication. The self-learning function allows the TOP code to be duplicated on other CAME radio control models and vice versa.

2 buttons: TOP42FGN - 806TS-0300

4 buttons: TOP44FGN - 806TS-0310



## **ORANGE TOP - FIXED CODE 433.92 - 868.35 MHZ**

It combines the convenience of fixed code technology with the versatility of dual frequency technology.

This version can transmit at either 433.92 MHz or 868.35 MHz according to the system specifications.

4 buttons: TOPD4FRN - 806TS-0330



# CXN BUS

MISTO CONNECTION

STAR CONNECTION

CHAIN CONNECTION

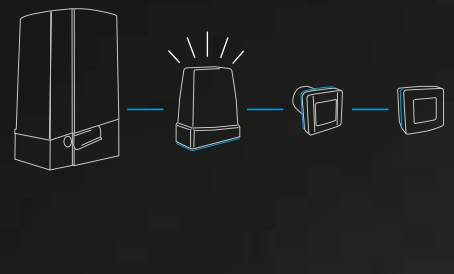
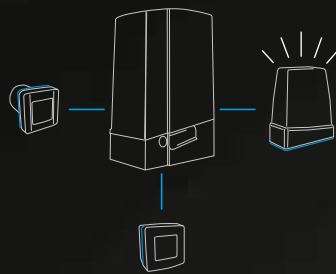
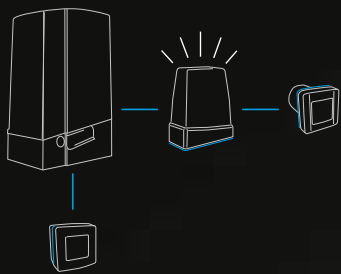

# ACCESSORIES WITH CXN BUS CONNECTION

With the CXN line of accessories with BUS technology, installation can be completed more easily and quickly. Each individual accessory can be configured after completing installation and setting the address of each device. It is also possible to obtain a complete diagnosis on each device.

The new control panels for swing gates ZLX24SA and ZLX24MA, the GARD GT4 and GARD GT8 barriers, and the new BXV PLUS have been developed with CXN BUS technology and therefore allow the connection of both traditional accessories and non-polarized 2-wire accessories.\*

## KEY-SWITCH SELECTORS

- 806SL-0070 wall-mounted key-operated with cylinder
- 806SL-0080 recess-mounted key-operated with cylinder
- 806SL-0030 wall-mounted
- 806SL-0040 recess-mounted

## BLUETOOTH SELECTORS

- 806SL-0340 wall-mounted 15 users
- 806SL-0350 wall-mounted 50 users
- 806SL-0360 wall-mounted 250 users

## KEYPAD SELECTORS

- 806SL-0280 wall-mounted
- 806SL-0290 recess-mounted

## TRANSPONDER SELECTORS

- Manchester:
  - 806SL-0300 wall-mounted
  - 806SL-0310 recess-mounted

## MIFARE:

- 806SL-0320 wall-mounted
- 806SL-0330 recess-mounted

\* ZLX24SA and ZLX24MA switchboards and the ZBC1 electronic board of BXV PLUS allow the connection of keypads and transponders only in CXN BUS mode.

## DLX SERIES PHOTOCELLS

- 806TF-0090 recess-mounted
- 806TF-0100 wall-mounted

## DXR SERIES PHOTOCELLS

- 806TF-0110 wall-mounted

## KRX SERIES FLASHING LIGHTS

- 806LA-0050 RGB light
- 806LA-0070 RGB light with integrated gateway

## EXPANSION MODULES

- 806XG-0080 2 inputs + 2 outputs

## 2-WIRE CXN BUS CONNECTION

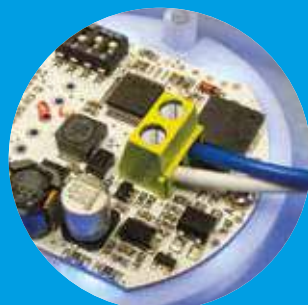

## RGB FLASHING LIGHT

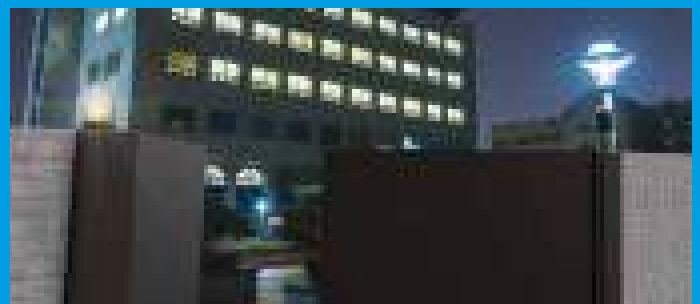

# European Standards

## EN 12453



Standards EN 12453 specify the compliance and safety requirements for automatic closing systems that could come in contact with people. They define all of the technical solutions for securing users' systems.

### THE SYSTEM CAN BE

- **IN PRIVATE AREA (fenced off)**
- **IN A PUBLIC AREA** or bordering with a public area despite being in a private area.

### USERS CAN BE

- **TRAINED**  
Users are trained when they are instructed on how to use the operator. Trained users typically work operators fitted on private property.
- **UNTRAINED**

### THE COMMAND CAN BE

- **NON SELF-LOCKING** (maintained action – man present).  
The operator is activated only thanks to automatically resetting buttons or selectors (for example, to activate an operator, you press a button. When the button is released, the operator stops). The operator is in full view of the user.
- **SENDING IMPULSES WITH SYSTEM CONTROL FROM A FIXED STATION.**  
The command must be impulse-type and sent from a fixed position from the system can be controlled. The button needn't be self-locking, that is, without automatically resetting button or selector.
- **RADIO-FREQUENCY CONTROL** (sending impulses without control of the system from a fixed station).  
Each impulse corresponds to a function (open, close, stop, etc.).
- **AUTOMATIC** (impulses).  
Each impulse sent corresponds to a maneuver cycle and not to a single function (open, close).



# Safety

## THE FRAMEWORKS PRESCRIBED BY EUROPEAN STANDARDS EN 12453

THE SYSTEM AND THE USER	THE COMMAND			
	With no self-locking	Sending impulses with system control from a fixed station	Sending impulses with no control of the system from a fixed station (radio control)	Automatic (impulse based)
PRIVATE area TRAINED user	A	C	C	C + D
PRIVATE area UNTRAINED user	C	C	C + D	C + D
PUBLIC area TRAINED user	B	C	C + D	C + D
PUBLIC area UNTRAINED user	-	C + D	C + D	C + D

## THE SAFETY DEVICES REQUIRED BY EUROPEAN STANDARDS EN 12453

- A** **Operator present** (with automatically resetting control device).
- B** **Operator present** (with manual resetting of the control device).
- C** **Mechanical and electronic devices, that is, sensitive safety-edges and encoders respectively.** Check compliance with maximum impact force regulatory standards. These standards are defined in the reference Technical Standards.
- D** **Infrared-beam photocells** for detecting any obstruction in the operator's range of action.



# SLIDING GATE AUTOMATION

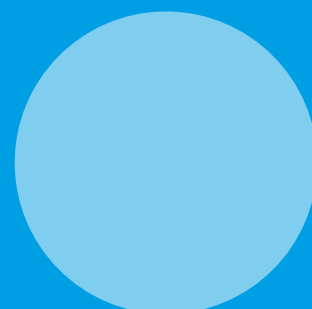
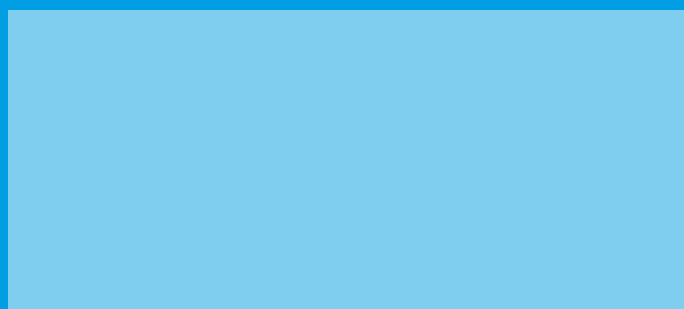
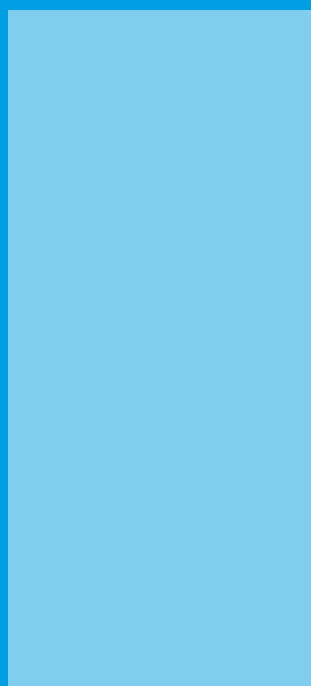

44	SELECTION GUIDE
48	BXL
50	BXV
54	BX
56	BK
60	BKV
64	BY-3500T
67	CONTROL BOARD FUNCTIONS

# Selection guide

## Sliding gate operators

The table summarizes the series and models with their maximum operating limits according to the weight and length of the gate leaf.

Series	Model	Max. weight per leaf (kg) / Max. length per leaf (m)
BXL	801MS-0140	400 / 10
BX	801MS-0020	400 / 14
BXV	801MS-0150	400 / 14
BXV	801MS-0160	400 / 14
BXV	801MS-0570	400 / 14
BXV	801MS-0180	600 / 18
BXV	801MS-0190	600 / 18
BXV	801MS-0380	600 / 18
BXV	801MS-0580	600 / 18
BX	801MS-0030	800 / 14
BXV	801MS-0210	800 / 20
BK	801MS-0070	800 / 20
BXV	801MS-0230	1000 / 20
BXV	801MS-0250	1000 / 20
BXV	801MS-0390	1000 / 20
BXV	801MS-0590	1000 / 20
BK	801MS-0080	1200 / 20
*BKV	801MS-0300	1500 / 20
*BKV	801MS-0350	1500 / 20
*BKV	801MS-0520	1500 / 20
BK	801MS-0090	1800 / 20
*BKV	801MS-0310	2000 / 20
*BKV	801MS-0360	2000 / 20
BK	801MS-0100	2200 / 20
BK	801MS-0120	2200 / 20
BK	801MS-0130	2200 / 23
*BKV	801MS-0320	2500 / 20
*BKV	801MS-0370	2500 / 20
BY-3500T	BY-3500T	3500 / 17

● 230 V AC ● 24 V DC HEAVY DUTY ● 230 – 400 V AC TRI-PHASE  
\*CONTINUOUS DUTY



## **SLIDING GATES RIGHT OR LEFT OPENING**

All CAME sliding gate automations are designed to be installed on either the right or left side of the gate.



## **PAIRED OPENING**

CAME's range of sliding gates lets you install two counterposed gearmotors.



## **INDUSTRIAL APPLICATION**

In industrial facilities, where tractor trailers, 18-wheel trucks and forklifts pass through, it is always advisable to fit double-height, infrared beam photocells, to prevent the gate from closing if one of the vehicles stops at the entry/exit point.

## The flashing light for movement signaling.

CAME has always suggested installing the flashing light as an additional safety feature for the automation system.

The KRX range, with LED technology, combines energy saving and great reliability with easy installation. KRX can be integrated with all CAME radio systems, is available in various colors, has a built-in radio antenna and each model can be powered from 24 V DC to 230 V AC.



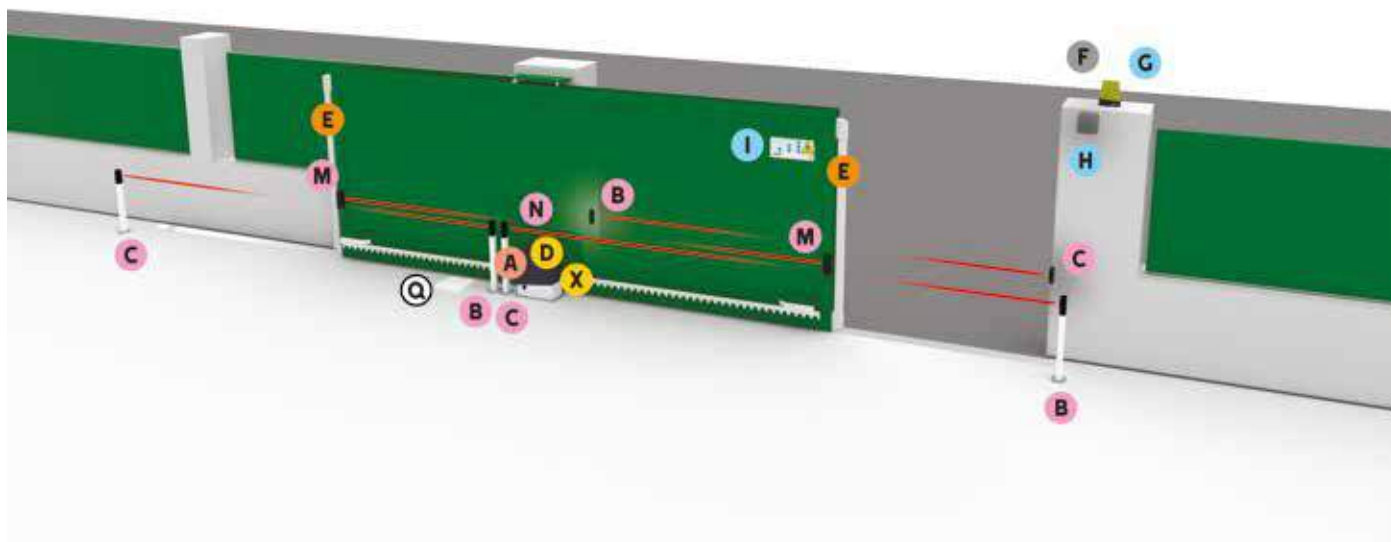

## COMPONENTS

- A** Operator (garmotor with control board)
- B** TX Photocells
- C** RX Photocells
- D** Power outage emergency operation board\*
- E** Sensitive safety-edges
- F** Flashing light
- G** Antenna
- H** Control switch  
(Key – Code – Card or transponder fob)
- I** Plaque
- M** Wireless module for controlling sensitive edges
- N** RX2 photocells
- Q** Junction box
- X** Radio frequency card

### NOTES:

The control board is integrated in the automation (except: 801MS-0130)

The radio frequency board can be integrated into the operator.

\* Only for 24 V DC operators.

## CABLES FOR STANDARD INSTALLATIONS

LENGTH OF CABLE (m)	< 10	from 10 to 20	from 20 to 30
Power supply 230 V AC	3G x 1.5 mm <sup>2</sup>	3G x 1.5 mm <sup>2</sup>	3G x 2.5 mm <sup>2</sup>
Power supply 230 - 400 V AC three phase	4G x 1.5 mm <sup>2</sup>	4G x 1.5 mm <sup>2</sup>	4G x 2.5 mm <sup>2</sup>
Power supply to motor 230 V AC	3G x 1.5 mm <sup>2</sup>	3G x 1.5 mm <sup>2</sup>	3G x 2.5 mm <sup>2</sup>
Power supply to motor 230 - 400 V AC three phase	4G x 1.5 mm <sup>2</sup>	4G x 1.5 mm <sup>2</sup>	4G x 2.5 mm <sup>2</sup>
Power supply to motor 24 or 36 V DC	2G x 1.5 mm <sup>2</sup>	2G x 1.5 mm <sup>2</sup>	2G x 2.5 mm <sup>2</sup>
Limit switch micro-switches	*no. x 0.5 mm <sup>2</sup>	*no. x 0.5 mm <sup>2</sup>	*no. x 0.5 mm <sup>2</sup>
Flashing light 24 V AC - DC	2 x 1 mm <sup>2</sup>	2 x 1 mm <sup>2</sup>	2 x 1 mm <sup>2</sup>
Flashing light 230 V AC	2 x 1.5 mm <sup>2</sup>	2 x 1.5 mm <sup>2</sup>	2 x 1.5 mm <sup>2</sup>
TX Photocells	2 x 0.5 mm <sup>2</sup>	2 x 0.5 mm <sup>2</sup>	2 x 0.5 mm <sup>2</sup>
RX Photocells	4 x 0.5 mm <sup>2</sup>	4 x 0.5 mm <sup>2</sup>	4 x 0.5 mm <sup>2</sup>
Control devices	*no. x 0.5 mm <sup>2</sup>	*no. x 0.5 mm <sup>2</sup>	*no. x 0.5 mm <sup>2</sup>
Antenna		RG58 max 10 m	

\*no. = see product mounting instructions - Attention: the cable section is merely indicative as it depends on the motor power and cable length.



# TTS

REFINED AND  
ELEGANT

DUAL FREQUENCY  
FIXED CODE AND  
ROLLING CODE

FIND OUT MORE ON PAGE 212

**CAME** 

[CAME.COM](http://CAME.COM)



MAXIMUM LEAF WEIGHT	MAXIMUM LEAF LENGTH	USE
400 kg	10 m SECTION	50%



### Solution for sliding gates in residential settings

- Encoder-based movement control.
- Complies with the rules on impact forces.
- Ready for operation in case of power outage.
- Self-diagnosing, hardwired safety devices.
- Control board with terminal blocks, dip switches and storage for up to 25 users.
- On-board rolling code decoding.

### Dimensions (mm)

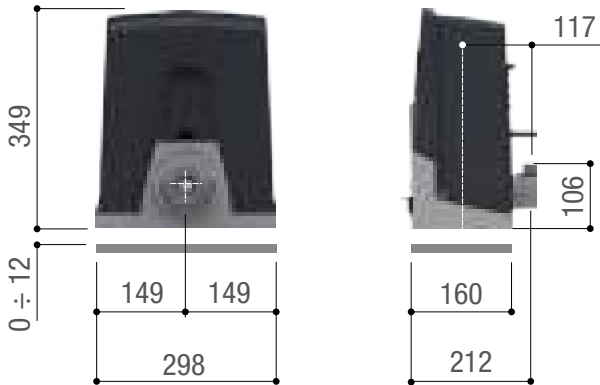

### Operational limits

MODELS	801MS-0140
Max. weight of leaf (kg)	400
Pinion module	4

### Technical characteristics

MODELS	801MS-0140
Protection rating (IP)	44
Power supply (V - 50/60 Hz)	230 AC
Power supply to motor (V)	24
Maximum draw (A)	7
Power (W)	170
Duty/cycle (%)	50
Thrust (N)	350
Pinion module	4
Operating temperature (°C)	-20 ÷ +55
Motor's heat protection (°C)	-20 ÷ +70

Code	Description
<b>Complete operators with 24 V DC gearmotor</b>	
<b>801MS-0140</b> 	BXL04AGS - Operator with 24 V motor, featuring a control board with dip-switch settings, on-board radio decoding, movement and obstruction-detection control for sliding gates weighing up to 400 kg that are up to 10-m long. RAL7024-grey cover.
<b>Accessories</b>	
001 <b>RGPI</b>	Green Power module to disconnect the transformer for energy saving while the operator is not in use.
001 <b>R800</b>	Control board for decoding and access-control management via keypad selectors.
<b>Accessories</b>	
002 <b>RLB</b> 	Circuit board for emergency operation and battery charging.
<b>Racks</b>	
009 <b>CGZ</b>	Module 4 rack made of 22 x 22 mm galvanized steel.
009 <b>CGZP</b>	Module 4 rack made of 10 x 10 mm PA6 nylon and steel-core fibre glass for sliding gates measuring up to 600 kg, plus fastening brace.
009 <b>CGZS</b>	Module 4 rack made of 30 x 8 mm galvanized steel with fastening holes and distancers.



## EASY RELEASE!

In emergencies or during power outages, the key-activated release is quick to get to and easy to use. The handy lever releases the gearmotor for manually opening the gate.

<b>MAXIMUM LEAF WEIGHT</b>	<b>MAXIMUM LEAF LENGTH</b>	<b>USE</b>
UP TO 1000 kg	UP TO 20 m	INTENSIVE USE



### Solution for sliding gates at private homes and apartment blocks

- Automation equipped with encoder also in the fast version.
- Ready for operation in case of power outage.
- Ready for installation of magnetic limit switches and heater.
- Control board with terminal blocks, display and storage for up to 250 users.
- Self-diagnosing safety devices.
- Paired connection via RSE accessory.
- Developed with CONNECT technology for remote digital control via gateway or locally via CAME KEY.

### Dimensions (mm)

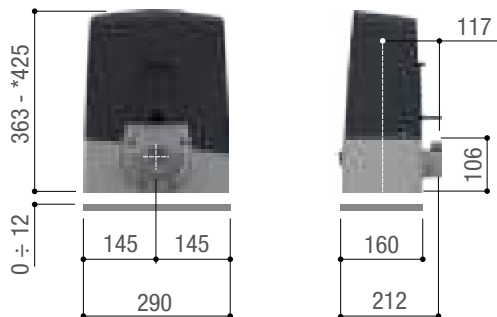

\* 801MS-0160 - 801MS-0190 - 801MS-0250

### Battery type

MODEL	BATTERY TYPE (not supplied)	MODEL	BATTERY TYPE (not supplied)
801MS-0150	2 x 12 V - 1.3 Ah	801MS-0250	2 x 12 V - 5 Ah
801MS-0160	2 x 12 V - 5 Ah	801MS-0380	2 x 12 V - 1.3 Ah
801MS-0180	2 x 12 V - 1.3 Ah	801MS-0390	2 x 12 V - 1.3 Ah
801MS-0190	2 x 12 V - 5 Ah	801MS-0570	2 x 12 V - 1.3 Ah
801MS-0210	2 x 12 V - 1.3 Ah	801MS-0580	2 x 12 V - 1.3 Ah
801MS-0230	2 x 12 V - 1.3 Ah	801MS-0590	2 x 12 V - 1.3 Ah

### Operational limits

MODELS	801MS-0150	801MS-0180	801MS-0210	801MS-0230	801MS-0160	801MS-0190	801MS-0250	801MS-0570	801MS-0580	801MS-0590
Max. weight of leaf (kg)	400	600	800	1000	400	600	1000	400	600	1000
Pinion module	4	4	4	4	4	4	4	4	4	4

### Technical characteristics

MODELS	801MS-0150	801MS-0180	801MS-0210	801MS-0230	801MS-0160
Protection rating (IP)	54	54	54	54	54
Power supply (V - 50/60 Hz)	230 AC	230 AC	230 AC	230 AC	230 AC
Power supply to motor (V)	24	24	24	24	24
Maximum draw (A)	7	11	16	16	10
Power (W)	170	270	400	400	240
Manouversing speed (m/min)	12	12	11	11	22
Duty/cycle (%)	HEAVY-DUTY SERVICE	HEAVY-DUTY SERVICE	HEAVY-DUTY SERVICE	HEAVY-DUTY SERVICE	HEAVY-DUTY SERVICE
Cycles/Hour	-	-	-	-	-
Thrust (N)	350	600	800	1000	250
Pinion module	4	4	4	4	4
Operating temperature (°C)	-20 ÷ +55	-20 ÷ +55	-20 ÷ +55	-20 ÷ +55	-20 ÷ +55
Motor's heat protection (°C)	-20 ÷ +70	-20 ÷ +70	-20 ÷ +70	-20 ÷ +70	-20 ÷ +70

## Code

## Description

### Complete operators with 24 V DC gearmotors, tested in compliance with regulatory standards EN 12453

**801MS-0150** BXV04AGS - Operator with 24 V motor, featuring a control board with display on-board radio decoding, movement and obstruction detection control for sliding gates weighing up to 400 kg that are up to 14-m long. RAL7024-grey cover.

**801MS-0180** BXV06AGS - Operator with 24 V motor, featuring a control board with display, on-board radio decoding, movement and obstruction-detection control for sliding gates weighing up to 600 kg that are up to 18-m long. RAL7024-grey cover.



### Complete operators with 24 V DC gearmotor

**801MS-0210** BXV08AGS - Operator with 24 V motor, featuring a control board with display, on-board radio decoding, movement and obstruction detecting device for sliding gates weighing up to 800 kg that are up to 20-m long. RAL7024-grey cover.

**801MS-0230** BXV10AGS - Operator with 24 V motor, featuring a control board with display, on-board radio decoding, movement and obstruction detecting device for sliding gates weighing up to 1,000 kg that are up to 20-m long. RAL7024-grey cover.



### Complete operators with 24 V DC gearmotor - FAST Version

**801MS-0160** BXV04AGF - Operator with 24 V motor, featuring a control board with display, on-board radio decoding, movement and obstruction detecting device for sliding gates up to 400 kg and 14 m length. Grey RAL7024 cover. Fast version up to 22 m/min.

**801MS-0190** BXV06AGF - Operator with 24 V motor, featuring a control board with display, on-board radio decoding, movement and obstruction detecting device for sliding gates up to 600 kg and 18 m length. Grey RAL7024 cover. Fast version up to 20 m/min.

**801MS-0250** BXV10AGF - Operator with 24 V motor, featuring a control board with display, on-board radio decoding, movement and obstruction detecting device for sliding gates up to 1000 kg and 20 m length. Grey RAL7024 cover. Fast version up to 20 m/min.



### Complete automations with 24 V DC gearmotor, tested according to EN 12453 standards - PLUS Version

**801MS-0570** BXV04AGE - Operator with 24 V motor, featuring a control board with graphic display, Adaptive Speed & Torque Technology, CXN BUS, B1-B2 contact output, on-board radio decoding, movement management and obstacle detection for gates weighing up to 400 kg that are up to 14-m long. RAL7024-grey cover.

**801MS-0580** BXV06AGE - Operator with 24 V motor, featuring a control board with graphic display, Adaptive Speed & Torque Technology, CXN BUS, B1-B2 contact output, on-board radio decoding, movement management and obstacle detection for gates weighing up to 600 kg that are up to 18-m long. RAL7024-grey cover.



### Complete operators with 24 V DC gearmotor - PLUS Version

**801MS-0590** BXV10AGE - Operator with 24 V motor, featuring a control board with graphic display, Adaptive Speed & Torque Technology, CXN BUS, B1-B2 contact output, on-board radio decoding, movement management and obstacle detection for gates weighing up to 1000 kg that are up to 20-m long. RAL7024-grey cover.





## Technical characteristics

MODELS	801MS-0190	801MS-0250	801MS-0570	801MS-0580	801MS-0590
Protection rating (IP)	54	54	54	54	54
Power supply (V - 50/60 Hz)	230 AC	230 AC	230 AC	230 AC	230 AC
Power supply to motor (V)	24	24	24	24	24
Maximum draw (A)	10	16	7	11	16
Power (W)	240	360	170	270	400
Manouversing speed (m/min)	20	20	12	12	11
Duty/cycle (%)	HEAVY-DUTY SERVICE	HEAVY-DUTY SERVICE	-	-	-
Cycles/Hour	-	-	CONTINUOUS SERVICE	CONTINUOUS SERVICE	CONTINUOUS SERVICE
Thrust (N)	330	450	350	600	1000
Pinion module	4	4	4	4	4
Operating temperature (°C)	-20 ÷ +55	-20 ÷ +55	-20 ÷ +55	-20 ÷ +55	-20 ÷ +55
Motor's heat protection (°C)	-20 ÷ +70	-20 ÷ +70	-20 ÷ +70	-20 ÷ +70	-20 ÷ +70

# THE COMPLETE RANGE

## Code Description

Code	Description
<b>CXN BUS interface for PLUS version automations</b>	
<b>806XG-0080</b> 	BUS expansion module with 2 inputs and 2 outputs. Inputs can be configured in NO, NC or resistive mode (8K2), a warning light output and a relay output.
<b>Accessories</b>	
001 <b>RSDN001</b>	Pull-cord release device for operators.
001 <b>RSDN002</b>	Magnetic limit-switch system for operators working in critical climatic conditions.
001 <b>RSDN003</b>	Heating system for operators installed in cold areas.
001 <b>RGP1</b>	Green Power module to disconnect the transformer for energy saving while the operator is not in use.
001 <b>R700</b>	Control board for decoding and access-control management via transponder selector.
001 <b>R800</b>	Control board for decoding and access-control management via keypad selectors.
002 <b>RSE</b>	Interface card for controlling two operators or for enabling the Came Remote Protocol.
<b>Accessories for: 001RSDN001</b>	
001 <b>H3000</b>	Case for remote release with customized key, plus pull-cord handle and control button. Cord length L = 5 m.
<b>Accessories</b>	
002 <b>RLB</b> 	Circuit board for emergency operation and battery charging.
<b>Racks</b>	
009 <b>CGZ</b>	Module 4 rack made of 22 x 22 mm galvanized steel.
009 <b>CGZP</b>	Module 4 rack made of 10 x 10 mm PA6 nylon and steel-core fibre glass for sliding gates measuring up to 600 kg, plus fastening brace.
009 <b>CGZS</b>	Module 4 rack made of 30 x 8 mm galvanized steel with fastening holes and distancers.



## WE CONNECT, YOU CONTROL.

The Cloud connection overhauls the way we process information. This technology revolutionizes lifestyles by ensuring comfort and security.

We have put all our CAME Connect products online. In this way we can control them from any smartphone or tablet.

Download the CAME AUTOMATION APP from Google Play or the APP Store.



## EASY RELEASE!

In emergencies or during power outages, the key-activated release is quick to get to and easy to use.

A convenient handle lets you release the gearmotor to manually open the gate.



# BLUETOOTH SELECTOR

FOR REMOTE  
CONTROL OF THE  
AUTOMATION

FIND OUT MORE ON PAGE 232

**CAME** 

[CAME.COM](http://CAME.COM)



<b>MAXIMUM LEAF WEIGHT</b>	<b>MAXIMUM LEAF LENGTH</b>	<b>USE</b>
UP TO 800 kg	14 m SECTION	30%

### Solution for sliding gates in residential settings

- Encoder-based movement control.
- Ready for installation of magnetic limit switches.
- Control board with terminal blocks, display and storage for up to 250 users.
- The safety inputs can be configured to directly control the 8k2Ω resistive sensitive-safety edges.
- Self-diagnosing safety devices.
- Developed with CONNECT technology for remote digital control via gateway or locally via CAME KEY.



### Dimensions (mm)

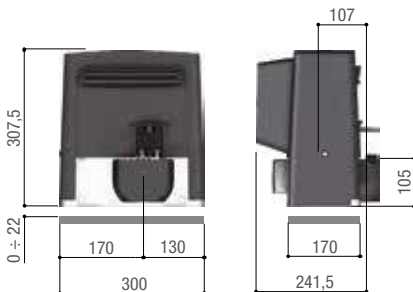

### Operational limits

MODELS	801MS-0020	801MS-0030
Max. weight of leaf (kg)	400	800
Pinion module	4	4

### Technical characteristics

MODELS	801MS-0020	801MS-0030
Protection rating (IP)	44	44
Power supply (V - 50/60 Hz)	230 AC	230 AC
Power supply to motor (V)	230	230
Absorption (A)	1,5	2,5
Power (W)	320	520
Maneuvering speed (m/min)	10,5	10,5
Cycles/Hour	17	17
Thrust (N)	600	800
Pinion module	4	4
Operating temperature (°C)	-20 ÷ +55	-20 ÷ +55

## Code Description

Operators with 230 V AC gearmotor, tested in compliance with regulatory standards EN 12453.

### 801MS-0020



BX704AGS - Operator with 230 V motor, featuring a control board with programming display, on-board radio decoding, movement and obstruction detecting device and mechanical limit-switches for sliding gates weighing up to 400 kg that are up to 14-m long. RAL7024-grey cover.



Complete operators with 230 V C gearmotor

### 801MS-0030



BX708AGS - Operator with 230 V motor, featuring a control board with programming display, on-board radio decoding, movement and obstruction detecting device and mechanical limit-switches for sliding gates weighing up to 800 kg that are up to 14-m long. RAL7024-grey cover.



### Accessories

#### 001RGP1

Green Power module to disconnect the transformer for energy saving while the operator is not in use.



#### 001R001

Lock cylinder with DIN key.



#### 001B4337

Chain drive device.



#### 009CCT

Simple 1/2" chain.



#### 009CGIU

Joint for 1/2" chain.



#### 001R700

Control board for decoding and access-control management via transponder selector.



#### 001R800

Control board for decoding and access-control management via keypad selectors.



#### 002RSE

Interface card for controlling two operators or for enabling the Came Remote Protocol.



#### 801XC-0100

Magnetic limit-switch system for operators working in critical climatic conditions.



### Racks

#### 009CGZ

Module 4 rack made of 22 x 22 mm galvanized steel.



#### 009CGZP

Module 4 rack made of 10 x 10 mm PA6 nylon and steel-core fibre glass for sliding gates measuring up to 600 kg, plus fastening brace.



#### 009CGZS

Module 4 rack made of 30 x 8 mm galvanized steel with fastening holes and distancers.



## DOWNLOAD THE CAME AUTOMATIONBT APP

AutomationBT is CAME's new app for Bluetooth selectors that lets you control your automated operators via smartphone. Activate the location service, receive alerts and open the gate. The Keyless function lets you even do it automatically.



MAXIMUM LEAF WEIGHT	MAXIMUM LEAF LENGTH	USE
UP TO 2200 kg	UP TO 23 m	UP TO 22 CYCLES/HOUR



## Solution for large sliding gates

- Available with module 4 or 6 pinion.
- Ready for installation of magnetic limit switches.
- Control board with terminal blocks, display and storage for up to 250 users.
- The safety inputs can be configured to directly control the 8k $\Omega$  resistive sensitive-safety edges.
- Self-diagnosing safety devices.
- 230 - 400 V AC three-phase version for 2200 Kg model.
- Developed with CONNECT technology for remote digital control via gateway or locally via CAME KEY.

## Dimensions (mm)



## Operational limits

MODELS	801MS-0070	801MS-0080	801MS-0090	801MS-0100	801MS-0120	801MS-0130
Max. weight of leaf (kg)	800	1200	1800	2200	2200	2200
Pinion module	4	4	4	6	4	6

## Technical characteristics

MODELS	801MS-0070	801MS-0080	801MS-0090	801MS-0100	801MS-0120	801MS-0130
Protection rating (IP)	44	44	44	44	44	44
Power supply (V - 50/60 Hz)	230 AC	230 AC	230 AC	230 AC	230 AC	230/400 AC TRIFASE
Power supply to motor (V)	230	230	230	230	230	230/400
Absorption (A)	4,5	3,3	4,2	5,1	5,1	1,5
Power (W)	520	380	480	580	580	520
Maneuvering speed (m/min)	10,5	10,5	10,5	10,5	10,5	10,5
Thrust (N)	800	850	1150	1500	1500	1650
Pinion module	4	4	4	6	4	6
Operating temperature (°C)	-20 ÷ +55	-20 ÷ +55	-20 ÷ +55	-20 ÷ +55	-20 ÷ +55	-20 ÷ +55
Motor's heat protection (°C)	-20 ÷ +70	-20 ÷ +70	-20 ÷ +70	-20 ÷ +70	-	-

● 230 V AC ● 230 – 400 V AC THREE PHASE

Code	Description
<b>Complete operators with 230 V C gearmotor</b>	
<b>801MS-0070</b> 	BKS08AGS - Operator with 230 V motor, featuring a control board with programming display, on-board radio decoding and mechanical limit-switches for sliding gates weighing up to 800 kg that are up to 20-m long. RAL7024-grey cover.
<b>801MS-0080</b> 	BKS12AGS - Operator with 230 V motor, featuring a control board with programming display, on-board radio decoding and mechanical limit-switches for sliding gates weighing up to 1,200 kg that are up to 20-m long. RAL7024-grey cover.
<b>801MS-0090</b> 	BKS18AGS - Operator with 230 V motor, featuring a control board with programming display, on-board radio decoding and mechanical limit-switches for sliding gates weighing up to 1,800 kg that are up to 20-m long. RAL7024-grey cover.
<b>801MS-0100</b> 	BKS22AGS - Operator with 230 V motor, featuring a control board with programming display, on-board radio decoding and mechanical limit-switches for sliding gates weighing up to 2,200 kg that are up to 20-m long. RAL7024-grey cover.
<b>801MS-0120</b> 	BKS22AGE - Operator with 230 V motor, featuring a control board with programming display, movement and obstruction detecting devices for sliding gates weighing up to 2,200 kg that are up to 20-m long. RAL7024-grey cover.
<b>230 - 400 V AC three-phase gearmotors</b>	
<b>801MS-0130</b> 	BKS22TGS - 230 - 400 V Gearmotor for sliding gates weighing up to 2,200 kg that are up to 23-m long.
<b>230 - 400 V AC three-phase control panels</b>	
<b>002ZT6N</b> 	Control panel with self-diagnosis of safety devices, configurable C1, CX resistive inputs, external soft start management, maximum number of users: 25.
<b>002ZT6NC</b> 	Control panel complete with safety lock and buttons with self-diagnosis of safety devices, configurable C1, CX resistive inputs, external soft start management, maximum number of users: 25.
<b>Accessories for: 801MS-0070 - 801MS-0080 - 801MS-0090 - 801MS-0100 - 801MS-0120</b>	
<b>801XC-0100</b>	Magnetic limit-switch system for operators working in critical climatic conditions.



# THE COMPLETE RANGE

Code	Description
<b>Accessories</b>	
001 <b>R001</b>	Lock cylinder with DIN key.
001 <b>B4353</b>	Chain drive device.
009 <b>CCT</b>	Simple 1/2" chain.
009 <b>CGIU</b>	Joint for 1/2" chain.
001 <b>RGP1</b>	Green Power module to disconnect the transformer for energy saving while the operator is not in use.
001 <b>R700</b>	Control board for decoding and access-control management via transponder selector.
001 <b>R800</b>	Control board for decoding and access-control management via keypad selectors.
002 <b>RSE</b>	Interface card for controlling two operators or for enabling the Came Remote Protocol.
<b>Racks</b>	
009 <b>CGZ</b>	Module 4 rack made of 22 x 22 mm galvanized steel.
009 <b>CGZS</b>	Module 4 rack made of 30 x 8 mm galvanized steel with fastening holes and distancers.
009 <b>CGZ6</b>	Galvanized rack module 6 in 30 x 30 laminated steel.



## WE CONNECT, YOU CONTROL.

The Cloud connection overhauls the way we process information. This technology revolutionizes lifestyles by ensuring comfort and security.

We have put all our CAME Connect products online. In this way we can control them from any smartphone or tablet.

Download the CAME AUTOMATION APP from Google Play or the APP Store.





# SEL DIGITAL

A COMPLETE  
RANGE OF  
SELECTORS TO SUIT  
EVERY NEED

FIND OUT MORE ON PAGE 230 - 232



**CAME** 

[CAME.COM](http://CAME.COM)

<b>MAXIMUM LEAF WEIGHT</b>	<b>MAXIMUM LEAF LENGTH</b>	<b>USE</b>
UP TO 2500 kg	20 m	CONTINUOUS OPERATION

### Solution for large sliding gates

- "Adaptive Speed and Torque Technology" to ensure a lasting, constant and smooth speed during movement.
- Control board with terminal blocks, graphic display and storage for up to 250 users.
- Four safety inputs which can be configured to directly manage the (8k $\Omega$ ) resistive sensitive safety-edges.
- User-friendly release lever for manually opening the gate.
- Set up to fit the 806SA-0120 clock control board for managing up to eight settings for opening and closing maneuvers.
- Protection rating against weathering agents (IP54).
- Ready for installation of magnetic limit switches (001RSDN002).
- Developed with CONNECT technology for remote digital control via gateway or locally via CAME KEY.



### Dimensions (mm)



### Operational limits

MODELS	801MS-0300	801MS-0310	801MS-0320	801MS-0350	801MS-0360	801MS-0370	801MS-0520
Max. weight of leaf (kg)	1500	2000	2500	1500	2000	2500	1500
Pinion module	4	4	6	4	4	6	4

### Technical characteristics

MODELS	801MS-0300	801MS-0310	801MS-0320	801MS-0350	801MS-0360	801MS-0370	801MS-0520
Protection rating (IP)	54	54	54	54	54	54	54
Power supply (V - 50/60 Hz)	230 AC	230 AC	230 AC	230 AC	230 AC	230 AC	230 AC
Power supply to motor (V)	36	36	36	36	36	36	36
Absorption (A)	8	9	10	8	9	10	10
Maximum draw (A)	20	20	20	20	20	20	20
Power (W)	200	250	300	200	250	300	300
Maneuvering speed (m/min)	12	12	12	12	12	12	12
Cycles/Hour	CONTINUOUS SERVICE	CONTINUOUS SERVICE	CONTINUOUS SERVICE	CONTINUOUS SERVICE	CONTINUOUS SERVICE	CONTINUOUS SERVICE	CONTINUOUS SERVICE
Thrust (N)	800	900	1000	800	900	1000	650
Pinion module	4	4	6	4	4	6	4
Operating temperature (°C)	-20 ÷ +55	-20 ÷ +55	-20 ÷ +55	-20 ÷ +55	-20 ÷ +55	-20 ÷ +55	-20 ÷ +55
Motor's heat protection (°C)	-20 ÷ +70	-20 ÷ +70	-20 ÷ +70	-20 ÷ +70	-20 ÷ +70	-20 ÷ +70	-

Code	Description
<b>Complete operators with 36 V DC geared motor</b>	
<b>801MS-0300</b> 	BKV15AGS - Operator with 36 V motor, featuring a control board with graphic display, Adaptive Speed & Torque Technology, 4 safety inputs, movement and obstruction detecting device for sliding gates weighing up to 1500 kg that are up to 20-m long. RAL7024-grey cover.
<b>801MS-0310</b> 	BKV20AGS - Operator with 36 V motor, featuring a control board with graphic display, Adaptive Speed & Torque Technology, 4 safety inputs, movement and obstruction detecting device for sliding gates weighing up to 2000 kg that are up to 20-m long. RAL7024-grey cover.
<b>801MS-0320</b> 	BKV25AGS - Automation with 36 V motor, complete with electronic board with graphic display, Adaptive Speed & Torque Technology, 4 safety inputs, movement management/obstacle detection and pinion module 6 for sliding gates up to 2500 kg and 20 m length.
<b>Complete operators with 36 V DC gearmotor - PLUS Version</b>	
<b>801MS-0350</b> 	BKV15AGE - Plus version operator with 36 V motor, featuring a control board with graphic display, Adaptive Speed & Torque Technology, 4 safety inputs, magnetic limit switches and clock accessory included for sliding gates weighing up to 1500 kg that are up to 20-m long. RAL7024-grey cover.
<b>801MS-0360</b> 	BKV20AGE - Plus version operator with 36 V motor, featuring a control board with graphic display, Adaptive Speed & Torque Technology, 4 safety inputs, magnetic limit switches and clock accessory included for sliding gates weighing up to 2000 kg that are up to 20-m long. RAL7024-grey cover.
<b>801MS-0370</b> 	BKV25AGE - Plus version operator with 36 V motor, featuring a control board with graphic display, Adaptive Speed & Torque Technology, 4 safety inputs, module 6 pinion, magnetic limit switches and clock accessory included for sliding gates weighing up to 2500 kg that are up to 20-m long. RAL7024-grey cover.
<b>Complete operators with 36 V DC gearmotor - REVERSIBILE Version</b>	
<b>801MS-0520</b> 	BKV15AGR - High performance operator with 36 V reversible motor, featuring a control board with graphic display, Adaptive Speed & Torque Technology, 4 safety inputs, movement and obstruction detecting device for gates weighing up to 1500 kg that are up to 20-m long. RAL 7040 grey cover.



## SMOOTH MOVEMENT AND SWIFTNESS IN ANY CONDITIONS

The new BKV series is designed to meet the highest standards in terms of performance at any latitude and in any climate. BKV motors feature state-of-the-art ADAPTIVE TORQUE AND SPEED TECHNOLOGY, that is, an integrated obstruction-detection software that, moment by moment, handles the current absorbed by the geared motor, to ensure the movement is super smooth, while keeping the speed constant according the installation parameters.

# THE COMPLETE RANGE

## Code Description

### Accessories

**806SA-0090** Circuit board for emergency operation and battery charging.

24



### Accessories

**801XC-0120** Chain drive device.



**801XC-0130** Adapter plate for first-series BK operators.



001**R001** Lock cylinder with DIN key.



009**CCT** Simple 1/2" chain.



009**CGIU** Joint for 1/2" chain.



001**RGP1** Green Power module to disconnect the transformer for energy saving while the operator is not in use.



001**R700** Control board for decoding and access-control management via transponder selector.



001**R800** Control board for decoding and access-control management via keypad selectors.



002**RSE** Interface card for controlling two operators or for enabling the Came Remote Protocol.



**806SA-0120** Control card for timer function-control with possibility to set daily/weekly opening and closing maneuvers.

001**RSDN002** Magnetic limit-switch system for operators working in critical climatic conditions.



### Racks

009**CGZ** Module 4 rack made of 22 x 22 mm galvanized steel.



009**CGZS** Module 4 rack made of 30 x 8 mm galvanized steel with fastening holes and distancers.



009**CGZ6** Galvanized rack module 6 in 30 x 30 laminated steel.





# BY-3500T

SLIDING GATE AUTOMATION



MAXIMUM LEAF WEIGHT	MAXIMUM LEAF LENGTH	USE
3500 kg	17 m	8 CYCLES/HOUR



## The ideal solutions for sliding gates at industrial sites.

- Sturdy mechanics to ensure exceptional performance.
- Self-diagnosing safety devices.
- Ready for the courtesy light management.
- Power supply 230 - 400 V AC Triphase to offer maximum performance.

## Dimensions (mm)

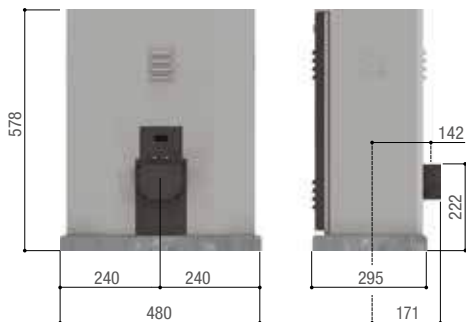

## Operational limits

MODELS	BY-3500T
Max. weight of leaf (kg)	3500
Pinion module	6

## Technical characteristics

MODELS	BY-3500T
Protection rating (IP)	54
Power supply (V - 50/60 Hz)	400 AC THREE-PHASE
Power supply to motor (V)	400
Maximum draw (A)	8
Power (W)	1000
Maneuvering speed (m/min)	10,5
Cycles/Hour	8
Thrust (N)	3500
Pinion module	6
Operating temperature (°C)	-20 ÷ +55
Motor's heat protection (°C)	-25 ÷ +70

● 230 – 400 V AC THREE PHASE

Code	Description
------	-------------

<b>Three-phase 230 – 400 V AC operators</b>	
---	--

001 <b>BY-3500T</b> 	BY3500T - Automation with three-phase 400 V AC motor, complete with control board and mechanical end stops for sliding gates up to 3.500 kg in weight and 17 m in length.
--	---



<b>Racks</b>	
--------------	--

009 <b>CGZ6</b>	Galvanized rack module 6 in 30 x 30 laminated steel.
-----------------	--





The table shows all of the characteristics of sliding-gate control panels.  
The ones in bold type are important for choosing which operator to install and should be assessed from the start.



Models / Series	BX	BK	BKV	BXL	BXV	BY-3500T BK	BXV (Plus)
Control board / Control panel	ZBX7N	ZBKN	ZN8	ZN6	ZN7	ZT6N	ZBC1
<b>Safety</b>							
SELF-DIAGNOSING safety decives	●	●	●	●	●	●	●
PRE-FLASHING when opening and closing	●	●	●	●	●	●	●
REOPENING during closing	●	●	●	●	●	●	●
CLOSING AGAIN during opening	●	●	●	●	●	●	●
Obstruction WAIT	●	●	●	●	●	●	●
TOTAL STOP	●	●	●	●	●	●	●
PARTIAL STOP	●	●	●	●	●	●	●
OBSTRUCTION DETECTION in front of photocells	●	●	●	●	●	●	●
ENCODER	●	●	●	●	●	●	●
MOVEMENT CONTROLLING and OBSTRUCTION DETECTING device.	●	●	●	●	●	●	●
AMPEROMETRIC DETECTION			●	●	●		●
<b>Command</b>							
PARTIAL OPENING 1 leaf	●	●	●	●	●	●	●
OPEN ONLY from transmitter and/or from button	●	●	●	●	●	●	●
ONLY OPEN or ONLY CLOSE button connection	●	●	●	●	●	●	●
OPEN-STOP-CLOSE-STOP from the transmitter and/or button	●	●	●	●	●	●	●
OPEN-CLOSE-INVERT from the transmitter and/or button	●	●	●	●	●	●	●
MAINTAINED ACTION	●	●	●	●	●	●	●
<b>Characteristics</b>							
FLASHING LIGHT connection	●	●	●	●	●	●	●
CYCLE LIGHT connection	●	●	●	●	●	●	●
COURTESY LIGHT connection		●	●				
Antenna	●	●	●	●	●	●	●
OPEN ALERT LIGHT connection	●	●	●	●	●	●	●
CLOSED ALERT LIGHT connection	●		●				●
Contact output for 2nd RADIO CHANNEL			●				●
SELF-LEARNING of the transmitter's RADIO CODE	●	●	●	●	●	●	●
Adjustable AUTOMATIC CLOSING AGAIN TIME	●	●	●	●	●	●	●
OPENING and/or CLOSING slow downs	●	●	●	●	●	●	●
EMERGENCY BATTERY operation (optional)			●	●	●		●
MASTER-SLAVE	●	●	●		●		●
Adjustable TRAVEL and SLOW-DOWN speeds*	●	●	●	●	●		●
DISPLAY	●	●			●		
Graphic DISPLAY			●				●
Electronic brake	●	●				●	
Connection to the solar panel					●		
CAME Connect	●	●	●	●	●		●
Designed to fit RIO System 2.0	●	●	●		●		●
CRP control	●	●	●		●		●
ENERGY SAVINGS control (001RGP1)	●	●	●	●	●		

● 230 V AC ● 24 - 36 V DC ● 230 - 400 V AC THREE PHASE

Note

\* For 801MS-0020 - 801MS-0030, only slow-down speed.

\*\* Encoder version only

# SWING GATE AUTOMATION

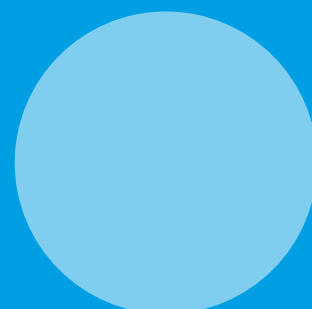
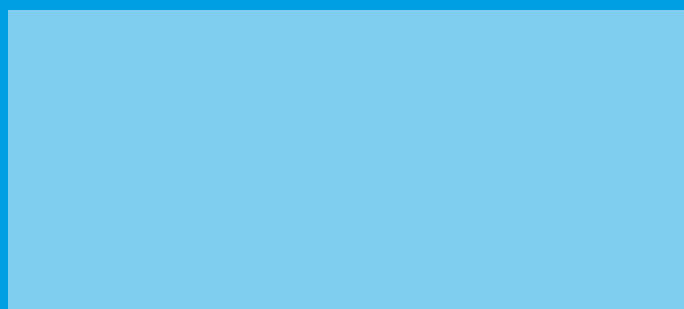
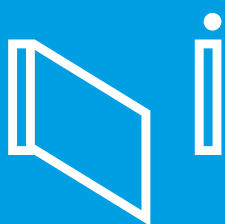
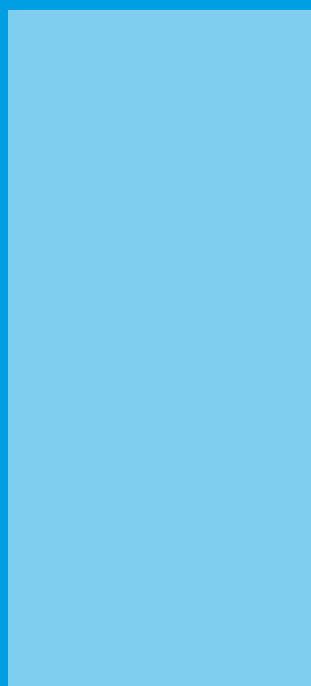

70	SELECTION GUIDE
76	ATS
80	AXL
82	AXI
84	AXO
86	ATI
88	KRONO
90	STYLO
92	FTL
94	FTX
98	FAST 70
102	FERNI
104	FROG
108	FROG PLUS
110	SUPER FROG
113	CONTROL BOARD FUNCTIONS

# Selection guide

## Swing gate operators

The table summarizes the series and models with their maximum operating limits only according to the width of the gate leaf.

Series	Model	Max. width of leaf (m)	Max. C-distance (mm)
FROG	FROG-AV	1.3	-
STYLO	STYLO-RME	1.8	180 (200 with item 001STYLO-BD)
STYLO	STYLO-ME	1.8	180 (200 with item 001STYLO-BD)
AXL	801MP-0020	2	60
AXI	801MP-0030	2	60
FTL	801MB-0080	2	150 (300 with item 801XC-0070)
FTL	801MB-0050	2	150 (300 with item 801XC-0070)
FTX	801MB-0140	2	150 (300 with item 801XC-0070)
FTX	801MB-0130	2	150 (300 with item 801XC-0070)
FTX	801MB-0150	2	150 (300 with item 801XC-0070)
FTX	801MB-0160	2	50 (300 with item 801XC-0070)
FAST 70	FA70230CB	2.3	200 (300 with item 801XC-0070)
FAST 70	FA70230	2.3	200 (300 with item 801XC-0070)
FAST 70	FA7024CB	2.3	200 (300 with item 801XC-0070)
FAST 70	FA7024	2.3	200 (300 with item 801XC-0070)
FAST 70	801MB-0090	2.3	300
FAST 70	801MB-0100	2.3	300
AXI	801MP-0040	2.5	60
ATS	801MP-0050	3	200
ATS	801MP-0070	3	200
ATS	801MP-0090	3	200
ATS	801MP-0110	3	200
ATI	A3000A	3	60
ATI	A3024N	3	60
ATI	A3000	3	60
AXO	AX302304	3	70
AXO	AX312304	3	70
AXO	AX3024	3	70
KRONO	KR300D - KR300S	3	60
KRONO	KR302D - KR302S	3	60
KRONO	KR310D - KR310S	3	60
KRONO	KR312D - KR312S	3	60
FROG	FROG-A	3.5	-
FROG	FROG-AE	3.5	-
FROG	FROG-A24	3.5	-
FROG	FROG-A24E	3.5	-
AXO	AX402306	4	70
AXO	AX412306	4	70
FERNI	FE40230	4	380
FERNI	FE40230V	4	380
FERNI	FE4024	4	380
FERNI	FE4024V	4	380
ATS	801MP-0060	5	200
ATS	801MP-0100	5	200
ATS	801MP-0080	5	200
AXO	AX5024	5	150
ATI	A5000A	5	120
ATI	A5024N	5	120
ATI	A5000	5	120
KRONO	KR510D - KR510S	5	120
KRONO	KR512D - KR512S	5	120
FROG PLUS	FROG-PM4	5.5	-
AXO	AX71230	7	150
FROG PLUS	FROG-PM6	7	-
SUPER FROG	FROG-MD - FROG-MS	8	-

● 230 V AC ● 24 V DC HEAVY DUTY ● 230 - 400 V AC TRI-PHASE



### SWING GATES BELOW-GROUND OPERATOR

It is practically invisible and does not change the gate's aesthetics.  
It does not limit the net clearance width.



### SWING GATES SURFACE OPERATOR

Simple installation with no setting up.  
It is by far the most popular among swing gates.



### SWING GATES HINGED-ARM GEARMOTORS

When the traditional surface-fitted gearmotor cannot be installed due to space limitations, the folding drive arm solves the issue.

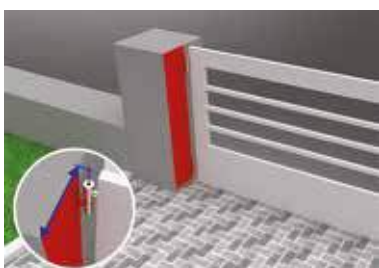

### MAXIMUM C-DISTANCE ON SWING GATES

That is the centre-distance between the inner corner of the post and the gate's rotating axis.  
The limits to this measurement allow you to pick the most suitable operator for any gate.

#### NOTES

In swing gates, the installation of an electric lock is always recommended to ensure reliable closing of the gates and to protect the gears of the gear motors.

- In the case of irreversible geared motors, it is always recommended, but becomes mandatory with leaves longer than 2.5 m.
- With reversible geared motors, it is necessary to ensure that the sash closes. In the latter case, it is however up to the installer, taking into account the size and type of sash (e.g. panelled) and the installation area (e.g. a windy area).

## The flashing light for movement signaling.

CAME has always suggested installing the flashing light as an additional safety feature for the automation system.

The KRX range, with LED technology, combines energy saving and great reliability with easy installation.

KRX can be integrated with all CAME radio systems, is available in various colors, has a built-in radio antenna and each model can be powered from 24 V DC to 230 V AC.



# SWING GATE WITH POWER ARM

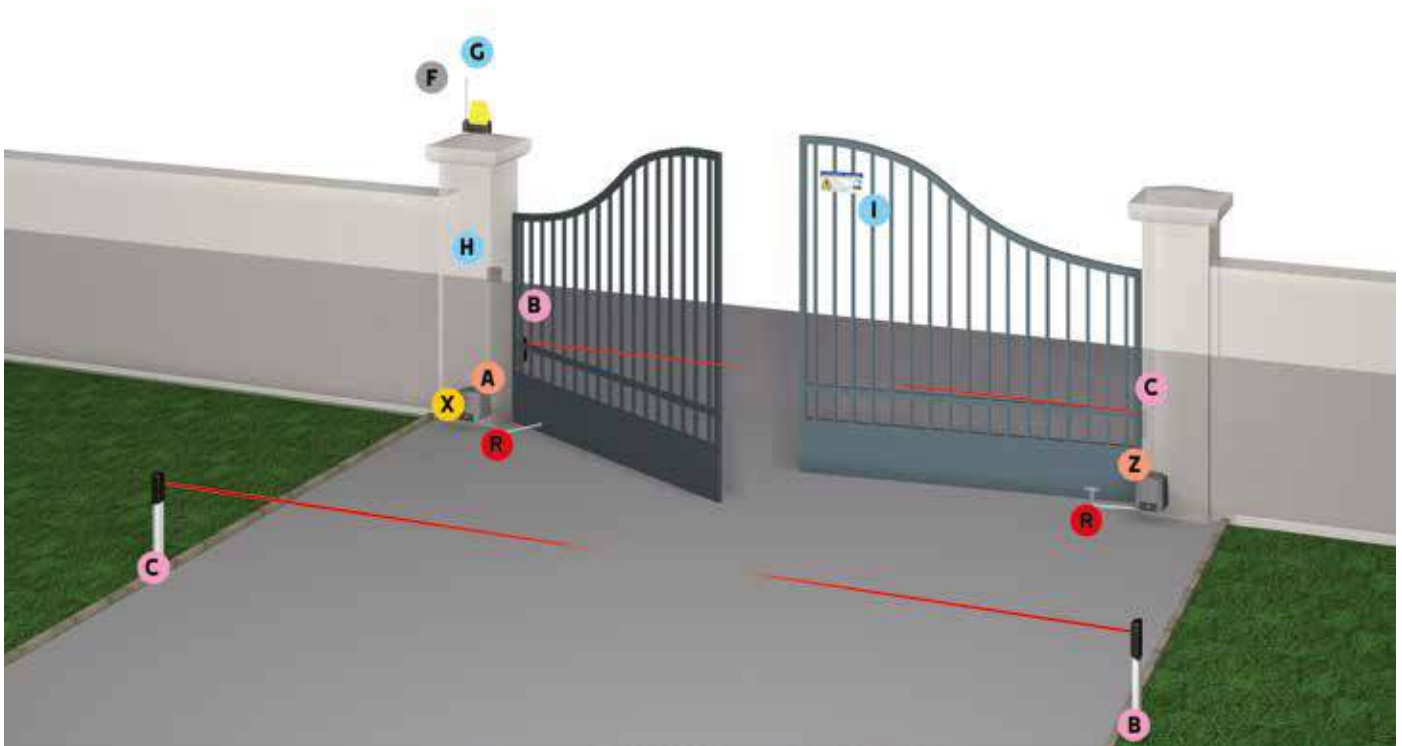

## COMPONENTS

- A** Operator (garmotor with control board)
- Z** Gearmotor
- B** TX Photocells
- C** RX Photocells
- F** Flashing light
- G** Antenna
- H** Control switch
- (Key – Code – Card or transponder fob)
- I** Plaque
- R** Drive levers
- X** Radio frequency card

## CABLES FOR STANDARD INSTALLATIONS

LENGTH OF CABLE (m)	< 10	from 10 to 20	from 20 to 30
Power supply 230 V AC	3G x 1.5 mm <sup>2</sup>	3G x 1.5 mm <sup>2</sup>	3G x 2.5 mm <sup>2</sup>
Power supply to motor 230 V AC	4G x 1.5 mm <sup>2</sup>	4G x 1.5 mm <sup>2</sup>	4G x 2.5 mm <sup>2</sup>
Power supply to motor 24 or 36 V DC	3G x 1.5 mm <sup>2</sup>	3G x 1.5 mm <sup>2</sup>	3G x 2.5 mm <sup>2</sup>
Limit switch micro-switches	4G x 1.5 mm <sup>2</sup>	4G x 1.5 mm <sup>2</sup>	4G x 2.5 mm <sup>2</sup>
Flashing light 24 V AC - DC	2G x 1.5 mm <sup>2</sup>	2G x 1.5 mm <sup>2</sup>	2G x 2.5 mm <sup>2</sup>
Flashing light 230 V AC	*no. x 0.5 mm <sup>2</sup>	*no. x 0.5 mm <sup>2</sup>	*no. x 0.5 mm <sup>2</sup>
TX Photocells	2 x 1 mm <sup>2</sup>	2 x 1 mm <sup>2</sup>	2 x 1 mm <sup>2</sup>
RX Photocells	2 x 1.5 mm <sup>2</sup>	2 x 1.5 mm <sup>2</sup>	2 x 1.5 mm <sup>2</sup>
Electric Lock 12 V DC	2 x 0.5 mm <sup>2</sup>	2 x 0.5 mm <sup>2</sup>	2 x 0.5 mm <sup>2</sup>
Electric Lock 24 V DC	4 x 0.5 mm <sup>2</sup>	4 x 0.5 mm <sup>2</sup>	4 x 0.5 mm <sup>2</sup>
Control devices	*no. x 0.5 mm <sup>2</sup>	*no. x 0.5 mm <sup>2</sup>	*no. x 0.5 mm <sup>2</sup>
Antenna		RG58 max 10 m	

\*no. = see product mounting instructions - Attention: the cable section is merely indicative as it depends on the motor power and cable length.

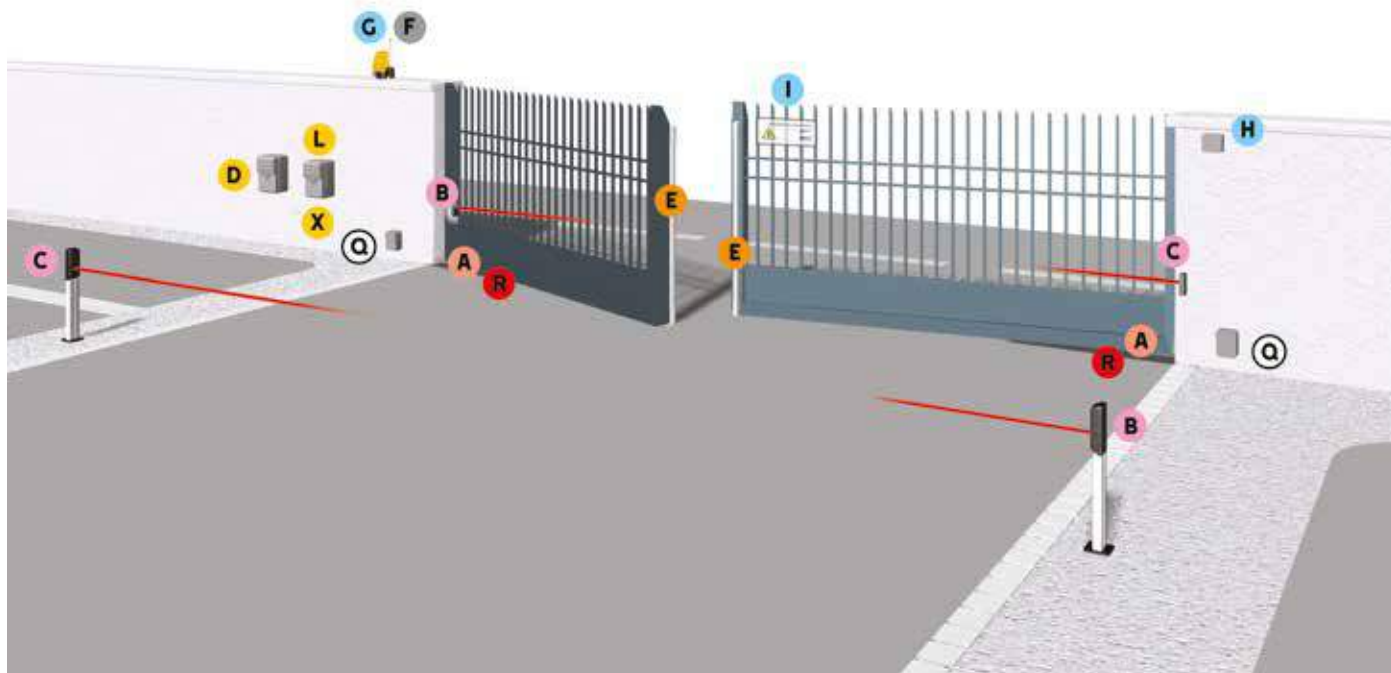

## COMPONENTS

- **A** Gearmotors
  - **B** TX Photocells
  - **C** RX Photocells
  - **D** Control card for operating during power outages
  - **E** Sensitive safety-edges
  - **F** Flashing light
  - **G** Antenna
  - **H** Control switch
  - **I** Plaque
  - **L** Control panel
  - **Q** Junction box (only for the Frog series)
  - **R** Drive levers
  - **X** Radio frequency card
- (Key – Code – Card or transponder fob)

## CABLES FOR STANDARD INSTALLATIONS

LENGTH OF CABLE (m)	< 10	from 10 to 20	from 20 to 30
Power supply 230 V AC	3G x 1.5 mm <sup>2</sup>	3G x 1.5 mm <sup>2</sup>	3G x 2.5 mm <sup>2</sup>
Power supply 230 - 400 V AC three phase	4G x 1.5 mm <sup>2</sup>	4G x 1.5 mm <sup>2</sup>	4G x 2.5 mm <sup>2</sup>
Power supply to motor 230 V AC	3G x 1.5 mm <sup>2</sup>	3G x 1.5 mm <sup>2</sup>	3G x 2.5 mm <sup>2</sup>
Power supply to motor 230 - 400 V AC three phase	4G x 1.5 mm <sup>2</sup>	4G x 1.5 mm <sup>2</sup>	4G x 2.5 mm <sup>2</sup>
Power supply to motor 24 or 36 V DC	2G x 1.5 mm <sup>2</sup>	2G x 1.5 mm <sup>2</sup>	2G x 2.5 mm <sup>2</sup>
Limit switch micro-switches	*no. x 0.5 mm <sup>2</sup>	*no. x 0.5 mm <sup>2</sup>	*no. x 0.5 mm <sup>2</sup>
Flashing light 24 V AC - DC	2 x 1 mm <sup>2</sup>	2 x 1 mm <sup>2</sup>	2 x 1 mm <sup>2</sup>
Flashing light 230 V AC	2 x 1.5 mm <sup>2</sup>	2 x 1.5 mm <sup>2</sup>	2 x 1.5 mm <sup>2</sup>
TX Photocells	2 x 0.5 mm <sup>2</sup>	2 x 0.5 mm <sup>2</sup>	2 x 0.5 mm <sup>2</sup>
RX Photocells	4 x 0.5 mm <sup>2</sup>	4 x 0.5 mm <sup>2</sup>	4 x 0.5 mm <sup>2</sup>
Electric Lock 12 V DC	2 x 1 mm <sup>2</sup>	2 x 1 mm <sup>2</sup>	2 x 1.5 mm <sup>2</sup>
Electric Lock 24 V DC	2 x 1 mm <sup>2</sup>	2 x 1 mm <sup>2</sup>	2 x 1 mm <sup>2</sup>
Control devices	*no. x 0.5 mm <sup>2</sup>	*no. x 0.5 mm <sup>2</sup>	*no. x 0.5 mm <sup>2</sup>
Antenna		RG58 max 10 m	

\*no. = see product mounting instructions - Attention: the cable section is merely indicative as it depends on the motor power and cable length.

# ZLX24



## ZLX24SA

The most complete and high-performance version, with graphic display and protective cover.

## ZLX24MA

The version with the main advanced functions, smaller dimensions and 7-segment display.

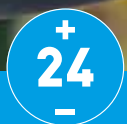

# THE UNIVERSAL 24 V CONTROL PANEL FOR SWING GATES

## CONNECT TECHNOLOGY

for digital automation management, both locally and remotely.

## COMPATIBLE WITH ALEXA

for voice-controlled automation management.

## ADVANCED ELECTRONIC FUNCTIONS

to simplify configuration operations, even from smartphones.

## ADAPTIVE SPEED AND TORQUE CONTROL

for maximum efficiency in all weather conditions.

## VIRTUAL ENCODER AND INTELLIGENT MOTION CONTROL

for obstacle detection and deceleration management.

## COMPATIBLE WITH CXN BUS SYSTEMS

for faster and more convenient wiring using a non-polarized 2-wire system.

## COMPATIBLE WITH THE WIRELESS RIO SYSTEM 2.0

for connecting accessories without wiring.

## EASY INSTALLATION

The control panel is mounted on a pivoting and removable base so that, when installing the box on the wall, it is possible to arrange the cables freely. The possibility of detaching the control panel from the box facilitates the wiring work and all the space under the board remains available for cable routing. In addition, the plastic box is equipped with a DIN BAR fixing system for even more practical and faster installation.



### COMPATIBLE 24V FIXED-ARM MOTORS

#### ATS



801MP-0070  
801MP-0080  
801MP-0110

#### ATI



001A3024N  
001A5024N

#### AXO



001AX3024  
001AX5024

#### AXI



801MP-0030  
801MP-0040

### COMPATIBLE 24V ARTICULATED ARM MOTORS

#### FTX



801MB-0050

#### FAST 70



001FA7024  
801MB-0100

#### FERNI



001FE4024  
001FE4024V

#### STYLO



001STYLO-ME  
001STYLO-RME

### UNDERGROUND 24V MOTORS

#### FROG



001FROG-A24  
01FROG-A24E

MAXIMUM LEAF LENGTH	MAXIMUM LEAF WEIGHT	USE	C MAX.
UP TO 5 m	UP TO 800 kg	CONTINUOUS OPERATION	200 mm

### Solution for applying in private homes and apartment buildings, on posts with C Max. up to 200 mm.



- Designed for applications with C Max. up to 200 mm.
- Sturdy and durable with die-cast aluminium supporting structure.
- Reducer with bevel gear for greater fluidity of movement.
- Release system, with the possibility of remote control.
- Developed with CONNECT technology for remote digital control via gateway or locally via CAME KEY.

### Dimensions (mm)

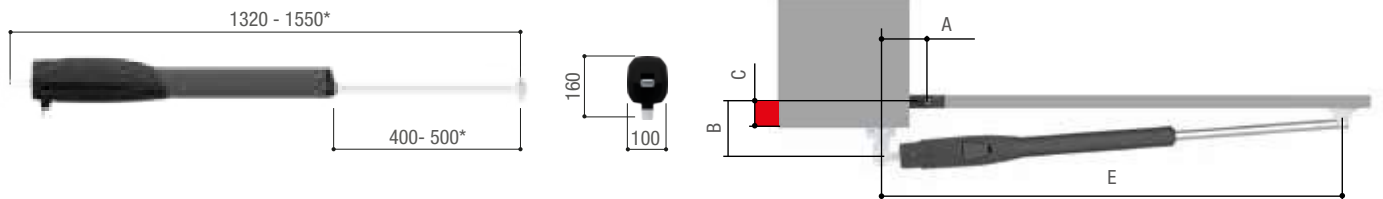

\*801MP-0060 · 801MP-0080

### Operational limits

MODELS	801MP-0050 · 801MP-0070 · 801MP-0090 · 801MP-0110
Max. length of leaf (m)	3    2,5    2
Max. weight of leaf (kg)	400    600    800
Max. leaf opening (°)	120

MODELS	801MP-0060 · 801MP-0080 · 801MP-0100
Max. length of leaf (m)	5    4    3    2,5    2
Max. weight of leaf (kg)	400    500    600    800    1000
Max. leaf opening (°)	120

### Application dimensions (mm)

ARTICULATED ARM	801MP-0050 · 801MP-0070 · 801MP-0090 · 801MP-0110
LEAF OPENING (°)	A    B <b>C Max.</b>
90	130    130    50
90	150    220    150
90	120    270    200
120	180    130    50

ARTICULATED ARM	801MP-0060 · 801MP-0080 · 801MP-0100
LEAF OPENING (°)	A    B <b>C Max.</b>
90	200    200    150
90	200    270    200
120	200    140    70

### Technical characteristics

MODELS	801MP-0050	801MP-0060	801MP-0090	801MP-0100	801MP-0070	801MP-0080	801MP-0110
Protection rating (IP)	54	54	54	54	54	54	54
Power supply to motor (V)	230 AC	230 AC	230 AC	230 AC	24 DC	24 DC	24 DC
Absorption (A)	1	1	1	1	8 MAX	8 MAX	8 MAX
Power (W)	250	250	250	250	80	80	80
Maneuvering time at 90° (s)	15	20	15	20	15 ÷ 30	15 ÷ 30	15 ÷ 30
Cycles/Hour	20	20	20	20	CONTINUOUS SERVICE	CONTINUOUS SERVICE	CONTINUOUS SERVICE
Thrust (N)	400 ÷ 3000	400 ÷ 3000	400 ÷ 3000	400 ÷ 3000	400 ÷ 3000	400 ÷ 3000	400 ÷ 3000
Operating temperature (°C)	-20 ÷ +55	-20 ÷ +55	-20 ÷ +55	-20 ÷ +55	-20 ÷ +55	-20 ÷ +55	-20 ÷ +55
Motor's heat protection (°C)	150	150	150	150	-	-	-

Code	Description
<b>230 V AC Gearmotors</b>	
<b>801MP-0050</b>	ATS30AGS - Irreversible telescopic 230 V gearmotor for swing gates with C Max. 200 mm with up to 3 m leaves that weighs up to 400 kg. RAL7024-gray color.
<b>801MP-0060</b>	ATS50AGS - Irreversible telescopic 230 V gearmotor for swing gates with C Max. 200 mm with up to 5 m leaves that weighs up to 400 kg. RAL7024 gray color.
<b>801MP-0090</b>	ATS30AGR - Irreversible telescopic 230 V gearmotor for swing gates with C Max. 200 mm, ready for remote release, with up to 3 m leaves that weighs up to 400 kg. RAL7024-gray color.
<b>801MP-0100</b>	ATS50AGR - Irreversible telescopic 230 V gearmotor for swing gates with C Max. 200 mm, ready for remote release, with up to 5 m leaves that weighs up to 400 kg. RAL7024-gray color.
<b>Control panels for 230 V AC gearmotors</b>	
002 <b>ZA3P</b>	Multifunction control panel for two-leaved swing gates, with limit-switch control and slow-down speed adjusting.
002 <b>ZM3E</b> 	Multifunction control panel for swing gates with two leaves, graphic programming and alerts display, plus self-diagnosing safety devices and on-board radio decoding.
<b>24 V DC gearmotors</b>	
<b>801MP-0070</b> 	ATS30DGS - Irreversible telescopic 24 V gearmotor with encoder for swing gates with C Max. 200 mm with up to 3 m leaves that weighs up to 400 kg. RAL7024-gray color.
<b>801MP-0080</b> 	ATS50DGS - Irreversible telescopic 24 V gearmotor with encoder for swing gates with C Max. 200 mm with up to 5 m leaves that weighs up to 400 kg. RAL7024-gray color.
<b>801MP-0110</b> 	ATS30DGR - Irreversible telescopic 24 V gearmotor with encoder for swing gates with C Max. 200 mm, ready for remote release, with up to 3 m leaves that weighs up to 400 kg. RAL7024-gray color.
<b>Control panels for 24 V gearmotors, tested in compliance with regulatory standards EN 12453</b>	
<b>801QA-0050</b> 	ZLX24MA - Multifunctional control panel, with 230 V AC power supply, for 24 V double-leaf gates, with programming and signaling display, self-diagnosis of safety devices, Adaptive Speed & Torque Technology, CXN BUS, 2 safety inputs and storage for up to 250 users.
<b>801QA-0060</b> 	ZLX24SA - Multifunctional control panel, with 230 V AC power supply, for 24 V double-leaf gates, with programming and graphical signaling display, self-diagnosis of safety devices, Adaptive Speed & Torque Technology, CXN BUS, 4 safety inputs and storage for up to 1000 users.
002 <b>ZL65</b> 	Control panel for one or two-leaf swing gates, with programming display, self-diagnosing safety devices and on-board radio decoding.

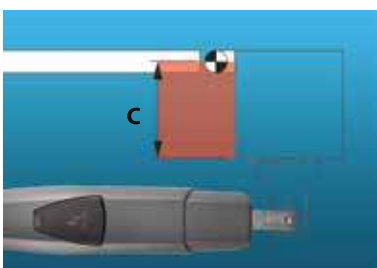

## C MAX UP TO 200 MM

ATS is the universal solution, ideal for both small or large residential settings. It is a very versatile operator and thanks to the telescopic extension it is able to adapt perfectly to posts of different depths.

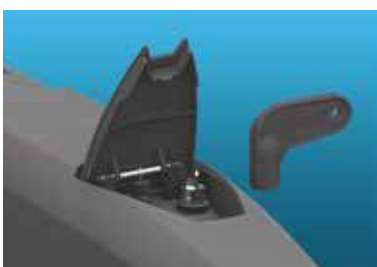

## EASY MANUAL RELEASE

In case of need it is possible to unlock the motor to open or close the gate leaf manually. A single gesture is sufficient to unlock ATS. The pin to be operated is protected by a flap that simply opens with a finger. The new tri-lobe key also has a completely new design, for greater ergonomics.

# THE COMPLETE RANGE

Code	Description
------	-------------

Accessories for: 801MP-0090 - 801MP-0100 - 801MP-0110

001 <b>H3000</b>	Case for remote release with customized key, plus pull-cord handle and control button. Cord length L = 5 m.
------------------	---



Accessori per: 002ZL65 - 801QA-0050 - 801QA-0060

002 <b>RLB</b>	Circuit board for emergency operation and battery charging.
----------------	---



CXN BUS interface for: 801QA-0050 - 801QA-0060

806 <b>XG-0080</b>	BUS expansion module with 2 inputs and 2 outputs. Inputs can be configured in NO, NC or resistive mode (8K2), a warning light output and a relay output.
--------------------	--



Accessories

001 <b>LOCK81</b>	Single cylinder electric lock.
-------------------	--------------------------------



001 <b>LOCK82</b>	Double cylinder electric lock.
-------------------	--------------------------------





# MONDRIAN

**TUBULAR MOTORS  
WITH MECHANICAL  
LIMIT SWITCH**

SEE THE AUTOMATIONS FOR AWNINGS,  
SHUTTERS AND BLINDS CATALOG.

**CAME** 

[CAME.COM](http://CAME.COM)



MAXIMUM LEAF LENGTH	MAXIMUM LEAF WEIGHT	USE	C MAX.
UP TO 2.2 m	UP TO 250 kg	50%	60 mm

### Solution for applying in private homes

- Gearmotor with bevel gear for greater fluidity of movement.
- Integrated, adjustable mechanical limit switches.
- Simplified connections and one, three-conductor cable.
- Control board with terminal blocks, dip switches and storage for up to 25 users.
- Release system protected by trilobe key.
- Ready for operation in case of power outage.



### Dimensions (mm)

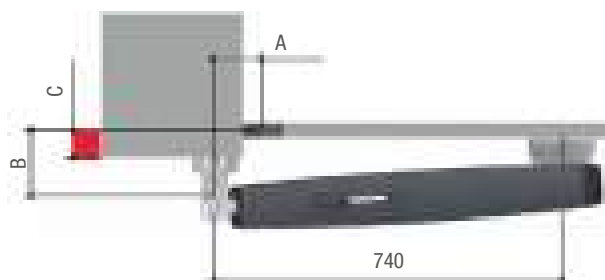

### Operational limits

MODELS	801MP-0020		
Max. length of leaf (m)	2,2	1,7	1
Max. weight of leaf (kg)	200	225	250
Max. leaf opening (°)	115		

### Application dimensions (mm)

MODELS	801MP-0020		
LEAF OPENING (°)	A	B	C Max.
90	130	110÷170	60
115	150	110÷160	50

### Technical characteristics

MODELS	801MP-0020
Protection rating (IP)	44
Power supply to motor (V)	24 DC
Maximum draw (A)	5
Power (W)	120
Maneuvering time at 90° (s)	15
Duty/cycle (%)	50
Thrust (N)	400 ÷ 2000

Code	Description
------	-------------

<b>24 V DC gearmotors, tested in compliance with regulatory standards EN 12453</b>	
--	--

<b>801MP-0020</b>	AXL20DGS - Irreversible 24 V operator with encoder for swing gates with leaf up to 2 m in length and 200 kg in weight. RAL7024, gray color.
-------------------	---



<b>Control panels for 24 V DC gearmotors tested in conformity with standards EN 12453</b>	
---	--

<b>002ZL60</b>	Control board for single and double leaf gates with dip switch settings, built-in radio decoding and self-diagnosis of safety devices.
----------------	--



<b>Accessories for: 002ZL60</b>	
---------------------------------	--

<b>002RLB</b>	Circuit board for emergency operation and battery charging.
---------------	---



<b>Accessories for: 002ZL60</b>	
---------------------------------	--

<b>001RGP1</b>	Green Power module to disconnect the transformer for energy saving while the operator is not in use.
----------------	--



<b>001R800</b>	Control board for decoding and access-control management via keypad selectors.
----------------	--



<b>Accessories</b>	
--------------------	--

<b>001RSWN001</b>	Pull-cord remote release device for operators.
-------------------	--



<b>Accessories for: 001RSWN001</b>	
------------------------------------	--

<b>001H3000</b>	Case for remote release with customized key, plus pull-cord handle and control button. Cord length L = 5 m.
-----------------	---



NOTES:  
002RLB - No. 2 12 V – 1.3 Ah batteries, not supplied.

MAXIMUM LEAF LENGTH	MAXIMUM LEAF WEIGHT	USE	C MAX.
UP TO 2.5 m	UP TO 250 kg	50%	60 mm

### Solution for applying in private homes and apartment buildings

- Gearmotor with bevel gear for greater fluidity of movement.
- Integrated, adjustable mechanical limit switches.
- Simplified connections and one, three-conductor cable.
- Control board with terminal blocks, display and storage for up to 250 users.
- Self-diagnosing safety devices.
- Ready for operation in case of power outage.
- Developed with CONNECT technology for remote digital control via gateway or locally via CAME KEY.



### Dimensions (mm)

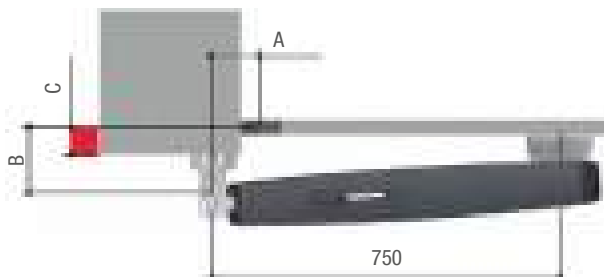

### Operational limits

MODELS	801MP-0030	
Max. length of leaf (m)	1,5	2
Max. weight of leaf (kg)	250	200
Max. leaf opening (°)	115	

MODELS	801MP-0040	
Max. length of leaf (m)	1,80	2,5
Max. weight of leaf (kg)	300	250
Max. leaf opening (°)	115	

### Application dimensions (mm)

ARTICULATED ARM	801MP-0030 · 801MP-0040		
LEAF OPENING (°)	A	B	C Max.
90	130	110 ÷ 170	60
115	150	110 ÷ 160	50

### Technical characteristics

MODELS	801MP-0030	801MP-0040
Protection rating (IP)	44	44
Power supply to motor (V)	24 DC	24 DC
Absorption (A)	5 Max.	5 Max.
Power (W)	120	120
Maneuvering time at 90° (s)	15*	15*
Duty/cycle (%)	50	50
Thrust (N)	400 ÷ 2000	400 ÷ 2000
Operating temperature (°C)	-20 ÷ +55	-20 ÷ +55

\* Suggested minimum value with maximum travel speed and minimum slow-down speed.

Code	Description
<b>24 V DC gearmotors, tested in compliance with regulatory standards EN 12453</b>	
<b>801MP-0030</b> 	AXI20DGS - Irreversible 24 V gearmotor with encoder for swing gates with up to 2 m leaves that weighs up to 200 kg. RAL7024-gray color.
<b>801MP-0040</b> 	AXI25DGS - Irreversible 24 V gearmotor with encoder for swing gates with up to 2.5 m leaves that weighs up to 250 kg. RAL7024-gray color.
<b>Control panels for 24 V DC gearmotors tested in conformity with standards EN 12453</b>	
<b>002ZL65</b> 	Control panel for one or two-leaf swing gates, with programming display, self-diagnosing safety devices and on-board radio decoding.
<b>801QA-0050</b> 	ZLX24MA - Multifunctional control panel, with 230 V AC power supply, for 24 V double-leaf gates, with programming and signaling display, self-diagnosis of safety devices, Adaptive Speed & Torque Technology, CXN BUS, 2 safety inputs and storage for up to 250 users.
<b>801QA-0060</b> 	ZLX24SA - Multifunctional control panel, with 230 V AC power supply, for 24 V double-leaf gates, with programming and graphical signaling display, self-diagnosis of safety devices, Adaptive Speed & Torque Technology, CXN BUS, 4 safety inputs and storage for up to 1000 users.
<b>CXN BUS interface for: 801QA-0050 - 801QA-0060</b>	
<b>806XG-0080</b> 	BUS expansion module with 2 inputs and 2 outputs. Inputs can be configured in NO, NC or resistive mode (8K2), a warning light output and a relay output.
<b>Accessories</b>	
<b>001RSWN001</b>	Pull-cord remote release device for operators.
<b>Accessories for: 001RSWN001</b>	
<b>001H3000</b>	Case for remote release with customized key, plus pull-cord handle and control button. Cord length L = 5 m.
<b>Accessori per: 002ZL65 - 801QA-0050 - 801QA-0060</b>	
<b>002RLB</b> 	Circuit board for emergency operation and battery charging.
<b>Accessories for: 002ZL65</b>	
<b>001RGP1</b>	Green Power module to disconnect the transformer for energy saving while the operator is not in use.
<b>001R700</b>	Control board for decoding and access-control management via transponder selector.
<b>001R800</b>	Control board for decoding and access-control management via keypad selectors.
<b>002RSE</b>	Interface card for controlling two operators or for enabling the Came Remote Protocol.



NOTES:  
002RLB - No. 2 12 V – 1.3 Ah batteries, not supplied.



## WE CONNECT. YOU CONTROL.

Cloud connectivity changes how we experience operators. This technology revamps our lifestyles, to ensure comfort and safety. CAME CONNECT make all our products available on the web where you can manage and control them from smartphones and tablets. Download CAME AUTOMATION APP from Google play or App Store.



MAXIMUM LEAF LENGTH	MAXIMUM LEAF WEIGHT	USE	C MAX.
UP TO 7 m	UP TO 800 kg	INTENSIVE USE	150 mm

### Solution for applying in private homes and apartment buildings

- Motor and encoder management with three-wire cable in 24 V DC versions.
- Supporting structure in die-cast aluminium.
- Ready for operation in case of power outage in the 24 V DC versions.
- Integrated, adjustable mechanical limit switches.
- Developed with CONNECT technology for remote digital control via gateway or locally via CAME KEY.



### Dimensions (mm)

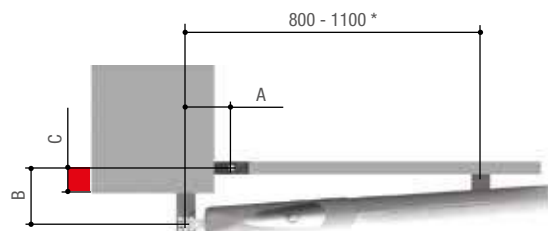
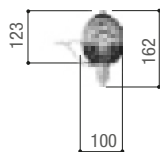
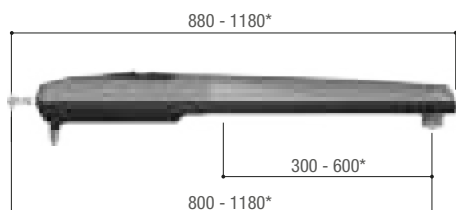

\* 001AX5024 · 001AX71230

### Operational limits

MODEL	AX302304 · AX312304 · AX3024						
Max. width of leaf (m)	3			2,5		2	
Max. weight of leaf (kg)	500			600		800	
MODEL	AX402306 · AX412306						
Max. width of leaf (m)	4		3		2,5		2
Max. weight of leaf (kg)	300		500		600		800
MODEL	AX5024						
Max. width of leaf (m)	5		4		3		2,5
Max. weight of leaf (kg)	400		500		700		800
1000							
MODEL	AX71230						
Max. width of leaf (m)	7	6	5	4	3	2,5	2
Max. weight of leaf (kg)	300	350	400	500	700	800	1000
Max. leaf opening (°)	120						

### Application dimensions (mm)

MODELS	AX302304 · AX312304 · AX402306 · AX412306 · AX3024		
LEAF OPENING (°)	A	B	C Max.
90	130	130	70
120	140	100	50
MODELS	AX5024 · AX71230		
LEAF OPENING (°)	A	B	C Max.
90	200	220	150
120	220	220	100

NOTES:  
Gates longer than 5 m must not be panelled.  
In reversible versions, in the event of strong wind with the gate open, the leaf may close again.

### Technical characteristics

MODELS	AX302304	AX312304	AX402306	AX412306	AX71230	AX3024	AX5024
Protection rating (IP)	44	44	44	44	44	44	44
Power supply (V - 50/60 Hz)	230 AC	230 AC	230 AC	230 AC	230 AC	-	-
Power supply to motor (V)	230 AC 50/60 Hz	230 AC 50/60 Hz	230 AC 50/60 Hz	230 AC 50/60 Hz	230 AC 50/60 Hz	24 DC	24 DC
Absorption (A)	1,5	1,5	1,5	1,5	1,5	10 Max.	10 Max.
Power (W)	175	175	175	175	175	120	120
Maneuvering time at 90° (s)	20	20	28	28	40	ADJUSTABLE	ADJUSTABLE
Duty/cycle (%)	50	50	30	30	30	HEAVY-DUTY SERVICE	HEAVY-DUTY SERVICE
Thrust (N)	500 ÷ 4500	500 ÷ 4500	500 ÷ 4500	500 ÷ 4500	500 ÷ 4500	500 ÷ 4500	500 ÷ 4500
Operating temperature (°C)	-20 ÷ +55	-20 ÷ +55	-20 ÷ +55	-20 ÷ +55	-20 ÷ +55	-20 ÷ +55	-20 ÷ +55
Motor's heat protection (°C)	150	150	150	150	150	-	-

Code	Description
<b>230 V AC gearmotors tested in compliance with regulatory standards EN 12453</b>	
001 <b>AX302304</b> 	Irreversible 230 V gearmotor with encoder for swing gates with up to 3 m leaves that weighs up to 500 kg.
001 <b>AX312304</b> 	Reversible 230 V gearmotor with encoder for swing gates with up to 3 m leaves that weighs up to 500 kg.
001 <b>AX402306</b> 	Irreversible 230 V gearmotor with encoder for swing gates with up to 4 m leaves that weighs up to 300 kg.
001 <b>AX412306</b> 	Reversible 230 V gearmotor with encoder for swing gates with up to 4 m leaves that weighs up to 300 kg.
<b>230 V AC Gearmotors</b>	
001 <b>AX71230</b> 	Reversible 230 V gearmotor with encoder for swing gates with up to 7 m leaves that weighs up to 300 kg.
<b>Control panels for 230 V AC gearmotors</b>	
002 <b>ZM3E</b> 	Multifunction control panel for swing gates with two leaves, graphic programming and alerts display, plus self-diagnosing safety devices and on-board radio decoding.
<b>24 V DC gearmotors, tested in compliance with regulatory standards EN 12453</b>	
001 <b>AX3024</b> 	Irreversible 24 V gearmotor with encoder for swing gates with up to 3 m leaves that weighs up to 500 kg.
001 <b>AX5024</b> 	Irreversible 24 V gearmotor with encoder for swing gates with up to 5 m leaves that weighs up to 400 kg.
<b>Control panels for 24 V gearmotors, tested in compliance with regulatory standards EN 12453</b>	
<b>801QA-0050</b> 	ZLX24MA - Multifunctional control panel, with 230 V AC power supply, for 24 V double-leaf gates, with programming and signaling display, self-diagnosis of safety devices, Adaptive Speed & Torque Technology, CXN BUS, 2 safety inputs and storage for up to 250 users.
<b>801QA-0060</b> 	ZLX24SA - Multifunctional control panel, with 230 V AC power supply, for 24 V double-leaf gates, with programming and graphical signaling display, self-diagnosis of safety devices, Adaptive Speed & Torque Technology, CXN BUS, 4 safety inputs and storage for up to 1000 users.
<b>Accessori per: 801QA-0050 - 801QA-0060</b>	
002 <b>RLB</b> 	Circuit board for emergency operation and battery charging.
<b>CXN BUS interface for: 801QA-0050 - 801QA-0060</b>	
<b>806XG-0080</b> 	BUS expansion module with 2 inputs and 2 outputs. Inputs can be configured in NO, NC or resistive mode (8K2), a warning light output and a relay output.
<b>Accessories</b>	
001 <b>LOCK81</b>	Single cylinder electric lock.
001 <b>LOCK82</b>	Double cylinder electric lock.



MAXIMUM LEAF LENGTH	MAXIMUM LEAF WEIGHT	USE	C MAX.
UP TO 5 m	UP TO 1000 kg	INTENSIVE DUTY	120 mm SECTION

### Solution for applying in private homes and apartment buildings

- Irreversible gearmotor.
- Amperometric obstruction detection.
- Ready for operation in case of power outage in the 24 V DC versions.



### Dimensions (mm)

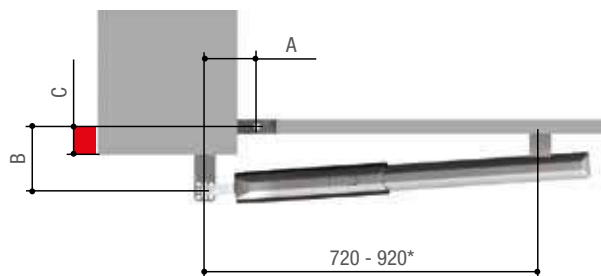
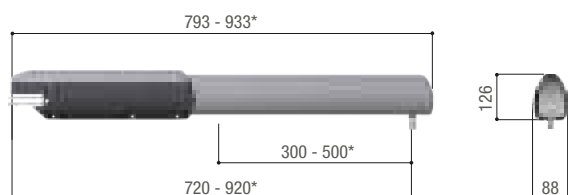

\* 001A5000 • 001A5024N

### Operational limits

MODEL	A3000 • A3000A • A3024N			
Max. width of leaf (m)	3	2,5	2	
Max. weight of leaf (kg)	400	600	800	
Max. leaf opening (°)	120			

MODEL	A5000 • A5000A • A5024N				
Max. width of leaf (m)	5	4	3	2,5	2
Max. weight of leaf (kg)	400	500	600	800	1000
Max. leaf opening (°)	120				

### Application dimensions (mm)

MODELS	A3000 • A3000A • A3024N		
LEAF OPENING (°)	A	B	C Max.
90	130	130	60
120	130	110	50

MODELS	A5000 • A5000A • A5024N		
LEAF OPENING (°)	A	B	C Max.
90	200	200	120
120	200	140	70



### Technical characteristics

MODELS	A3000	A3000A	A5000	A5000A	A3024N	A5024N
Protection rating (IP)	44	44	44	44	44	44
Power supply to motor (V)	230 AC 50/60 Hz	230 AC 50/60 Hz	230 AC 50/60 Hz	230 AC 50/60 Hz	24 DC	24 DC
Absorption (A)	1,2	1,2	1,2	1,2	10 Max.	10 Max.
Power (W)	260	260	260	260	120	120
Maneuvering time at 90° (s)	19 ÷ 25	19 ÷ 25	30 ÷ 40	30 ÷ 40	ADJUSTABLE	ADJUSTABLE
Cycles/Hour	24	24	15	15	HEAVY-DUTY SERVICE	HEAVY-DUTY SERVICE
Thrust (N)	400 ÷ 4000	400 ÷ 4000	400 ÷ 4000	400 ÷ 4000	400 ÷ 4000	400 ÷ 4000
Operating temperature (°C)	-20 ÷ +55	-20 ÷ +55	-20 ÷ +55	-20 ÷ +55	-20 ÷ +55	-20 ÷ +55
Motor's heat protection (°C)	150	150	150	150	-	-

● 230 V AC ● 24 V DC

## Code Description





### 230 V AC Gearmotors

001 <b>A3000</b>	Irreversible 230 V gearmotor for swing gates with opening limit-switch micro-switches with up to 3 m leaves that weighs up to 400 kg.	
001 <b>A3000A</b>	Irreversible 230 V gearmotor with opening and closing limit-switch micro-switches for swing gates with up to 3 m leaves that weighs up to 400 kg.	
001 <b>A5000</b>	Irreversible 230 V gearmotor with opening limit-switch micro-switches for swing gates with up to 5 m leaves that weighs up to 400 kg.	
001 <b>A5000A</b>	Irreversible 230 V gearmotor with opening and closing limit-switch micro-switches for swing gates with up to 5 m leaves that weighs up to 400 kg.	





### Control panels for 230 V AC gearmotors

002 <b>ZA3P</b>	Multifunction control panel for two-leaved swing gates, with limit-switch control and slow-down speed adjusting.	
-----------------	--	---



### 24 V DC gearmotors

001 <b>A3024N</b> 	Irreversible 24 V gearmotor for swing gates with up to 3 m leaves that weighs up to 400 kg.	
001 <b>A5024N</b> 	Irreversible 24 V gearmotor with opening limit-switch micro-switch and closing micro-switch for swing gates with up to 5 m leaves that weighs up to 400 kg.	



### Control panels for 24 V DC gearmotors

<b>801QA-0050</b> 	ZLX24MA - Multifunctional control panel, with 230 V AC power supply, for 24 V double-leaf gates, with programming and signaling display, self-diagnosis of safety devices, Adaptive Speed & Torque Technology, CXN BUS, 2 safety inputs and storage for up to 250 users.	
<b>801QA-0060</b> 	ZLX24SA - Multifunctional control panel, with 230 V AC power supply, for 24 V double-leaf gates, with programming and graphical signaling display, self-diagnosis of safety devices, Adaptive Speed & Torque Technology, CXN BUS, 4 safety inputs and storage for up to 1000 users.	





### Accessori per: 801QA-0050 - 801QA-0060

002 <b>RLB</b> 	Circuit board for emergency operation and battery charging.	
---	---	---

### CXN BUS interface for: 801QA-0050 - 801QA-0060

<b>806XG-0080</b> 	BUS expansion module with 2 inputs and 2 outputs. Inputs can be configured in NO, NC or resistive mode (8K2), a warning light output and a relay output.	
--	--	---

### Accessories

001 <b>LOCK81</b>	Single cylinder electric lock.	
001 <b>LOCK82</b>	Double cylinder electric lock.	
001 <b>D001</b>	Lock cylinder with DIN key.	
001 <b>H3000</b>	Case for remote release with customized key, plus pull-cord handle and control button. Cord length L = 5 m.	

# KRONO

## SWING GATE AUTOMATION

MAXIMUM LEAF LENGTH	MAXIMUM LEAF WEIGHT	USE	C MAX.
UP TO 5 m	UP TO 1000 kg	16 CYCLES/HOUR	120 mm SECTION



### Solution for applying in private homes

- Supporting structure in die-cast aluminium.
- Adjustable opening/closing microswitches.
- Built-in emergency release lever.

### Dimensions (mm)

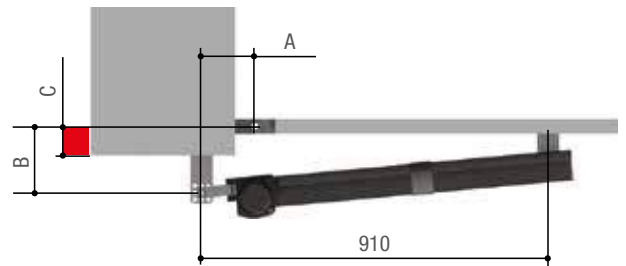

\* 001KR510D · 001KR510S

### Operational limits

MODEL	KR300D · KR300S · KR302D · KR302S · KR310D · KR310S · KR312D · KR312S		
Max. width of leaf (m)	3	2,5	2
Max. weight of leaf (kg)	400	600	800
Max. leaf opening (°)	120		

MODEL	KR510D · KR510S · KR512D · KR512S				
Max. width of leaf (m)	5	4	3	2,5	2
Max. weight of leaf (kg)	400	500	600	800	1000
Max. leaf opening (°)	120				

### Application dimensions (mm)

MODELS	KR300D · KR300S · KR302D · KR302S · KR310D · KR310S · KR312D · KR312S		
LEAF OPENING (°)	A	B	C Max.
90	130	130	60
120	130	110	50

MODELS	KR510D · KR510S · KR512D · KR512S		
LEAF OPENING (°)	A	B	C Max.
90	200	200	120
130	200	140	70

### Technical characteristics

MODELS	KR300D/S	KR310D/S	KR510D/S	KR302D/S	KR312D/S	KR512D/S
Protection rating (IP)	54	54	54	54	54	54
Power supply (V - 50/60 Hz)	230 AC	230 AC	230 AC	230 AC	230 AC	230 AC
Power supply to motor (V)	230 AC	230 AC	230 AC	230 AC	230 AC	230 AC
Absorption (A)	1,1	1,1	1,1	1,35	1,35	1,35
Power (W)	240	240	240	300	300	300
Maneuvering time at 90° (s)	22	22	34	15	15	22
Cycles/Hour	16	16	10	16	16	10
Thrust (N)	400 ÷ 3000	400 ÷ 3000	400 ÷ 3000	400 ÷ 3000	400 ÷ 3000	400 ÷ 3000
Operating temperature (°C)	-20 ÷ +55	-20 ÷ +55	-20 ÷ +55	-20 ÷ +55	-20 ÷ +55	-20 ÷ +55
Motor's heat protection (°C)	150	150	150	150	150	150

• 230 V AC

Code	Description
<b>230 V AC Gearmotors</b>	
001 <b>KR300D</b>	Irreversible right 230 V gearmotor for swing gates with up to 3 m leaves that weighs up to 400 kg.
001 <b>KR300S</b>	Irreversible left 230 V gearmotor for swing gates with up to 3 m leaves that weighs up to 400 kg.
001 <b>KR310D</b>	Irreversible right 230 V gearmotor with opening and closing limit-switch micro-switches, for swing gates with up to 3 m leaves that weighs up to 400 kg.
001 <b>KR310S</b>	Irreversible left 230 V gearmotor with opening and closing limit-switch micro-switches, for swing gates with up to 3 m leaves that weighs up to 400 kg.
001 <b>KR510D</b>	Irreversible right 230 V gearmotor with opening and closing limit-switch micro-switches for swing gates with up to 5 m leaves that weighs up to 400 kg.
001 <b>KR510S</b>	Irreversible left 230 V gearmotor with opening and closing limit-switch micro-switches for swing gates with up to 5 m leaves that weighs up to 400 kg.
<b>230 V AC Operators - RAPID version</b>	
001 <b>KR302D</b>	Irreversible right 230 V gearmotor, rapid version, for swing gates with up to 3 m leaves that weighs up to 400 kg.
001 <b>KR302S</b>	Irreversible left 230 V gearmotor, rapid version, for swing gates with up to 3 m leaves that weighs up to 400 kg.
001 <b>KR312D</b>	Irreversible right 230 V gearmotor, rapid version, with opening and closing limit-switch microswitches, for swing gates with up to 3 m leaves that weighs up to 400 kg.
001 <b>KR312S</b>	Irreversible left 230 V gearmotor, rapid version, with opening and closing limit-switch microswitches, for swing gates with up to 3 m leaves that weighs up to 400 kg.
001 <b>KR512D</b>	230 V right irreversible operator, fast version, with opening and closing limit switches for swing gates with leaves up to 5 m that weigh 400 kg.
001 <b>KR512S</b>	230 V left irreversible operator, rapid version, with opening and closing limit switches for swing gates with leaves up to 5 m that weigh 400 kg.
<b>Control panels for 230 V AC gearmotors</b>	
002 <b>ZA3P</b>	Multifunction control panel for two-leaved swing gates, with limit-switch control and slow-down speed adjusting.
<b>Accessories</b>	
001 <b>KR001</b>	Lock cylinder with DIN key.



MAXIMUM LEAF LENGTH	MAXIMUM LEAF WEIGHT	USE	C MAX.
UP TO 1.8 m	UP TO 150 KG	INTENSIVE USE	200 mm



### Solution for fitting on posts where little space is available

- For installations on posts with a minimum width of 8 cm.
- Encoder-based movement control.
- Reversible or irreversible gearmotor
- They can also be installed close to a wall with the STYLO-BD accessory.
- Ready for operation in case of power outage.
- Custom-key release system.

### Dimensions (mm)

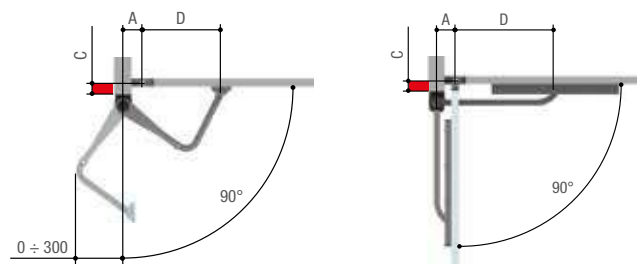
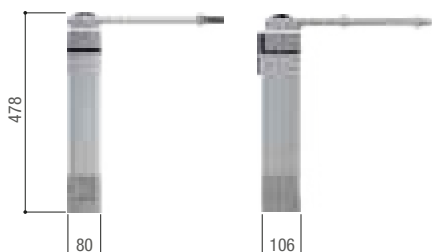

### Operational limits

MODEL	STYLO-ME · STYLO-RME		
Max. width of leaf (m)	1,8	1,2	0,8
Max. weight of leaf (kg)	100	125	150
Max. leaf opening (°)	120 (with STYLO-BS arm) - 135 (with STYLO-BD arm)		

### Application dimensions (mm)

ARTICULATED ARM	STYLO-BS		
LEAF OPENING (°)	A	D	C Max.
90	90	450	0
90	90	450	180
90	130	450	180
120	170	450	0
STRAIGHT ARM	STYLO-BD		
LEAF OPENING (°)	A	D	C Max.
90	90	400	200
90	230	300	180
135	230	300	0

### Technical characteristics

MODELS	STYLO-ME	STYLO-RME
Protection rating (IP)	54	54
Power supply to motor (V)	24 DC	24 DC
Absorption (A)	5 Max.	5 Max.
Power (W)	48	48
Maneuvering time at 90° (s)	ADJUSTABLE	ADJUSTABLE
Duty/cycle (%)	HEAVY-DUTY SERVICE	HEAVY-DUTY SERVICE
Thrust (N)	100	100
Operating temperature (°C)	-20 ÷ +55	-20 ÷ +55

## Code Description

### 24 V DC gearmotors, tested in compliance with regulatory standards EN 12453

**001STYLO-ME** Irreversible 24 V gearmotor with encoder for swing gates with up to 1.8 m leaves that weighs up to 100 kg.



**001STYLO-RME** Reversible 24 V gearmotor with encoder for swing gates with up to 1.8 m leaves that weighs up to 100 kg.



### Control panels for 24 V DC gearmotors tested in conformity with standards EN 12453

**801QA-0050** ZLX24MA - Multifunctional control panel, with 230 V AC power supply, for 24 V double-leaf gates, with programming and signaling display, self-diagnosis of safety devices, Adaptive Speed & Torque Technology, CXN BUS, 2 safety inputs and storage for up to 250 users.



**801QA-0060** ZLX24SA - Multifunctional control panel, with 230 V AC power supply, for 24 V double-leaf gates, with programming and graphical signaling display, self-diagnosis of safety devices, Adaptive Speed & Torque Technology, CXN BUS, 4 safety inputs and storage for up to 1000 users.



### Accessori per: 801QA-0050 - 801QA-0060

**002RLB** Circuit board for emergency operation and battery charging.



### CXN BUS interface for: 801QA-0050 - 801QA-0060

**806XG-0080** BUS expansion module with 2 inputs and 2 outputs. Inputs can be configured in NO, NC or resistive mode (8K2), a warning light output and a relay output.



### Accessories

**001STYLO-BS** Folding drive arm.



**001STYLO-BD** Straight drive arm and track with mechanical opening limit-switch.



### Accessories for: 001STYLO-RME

**001LOCK81** Single cylinder electric lock.



**001LOCK82** Double cylinder electric lock.



MAXIMUM LEAF LENGTH	MAXIMUM LEAF WEIGHT	USE	C MAX.
UP TO 2 m	UP TO 250 kg	40 CYCLES/HOUR	300 mm

### Solution for applying in private homes and apartment buildings, on small and medium-sized gate posts



- Encoder-based movement control.
- Control board with terminal blocks, dip switches and storage for up to 25 users.
- Ready for operation in case of power outage.
- Self-diagnosing safety devices.
- User-friendly release lever for manually opening the gate.

### Dimensions (mm)

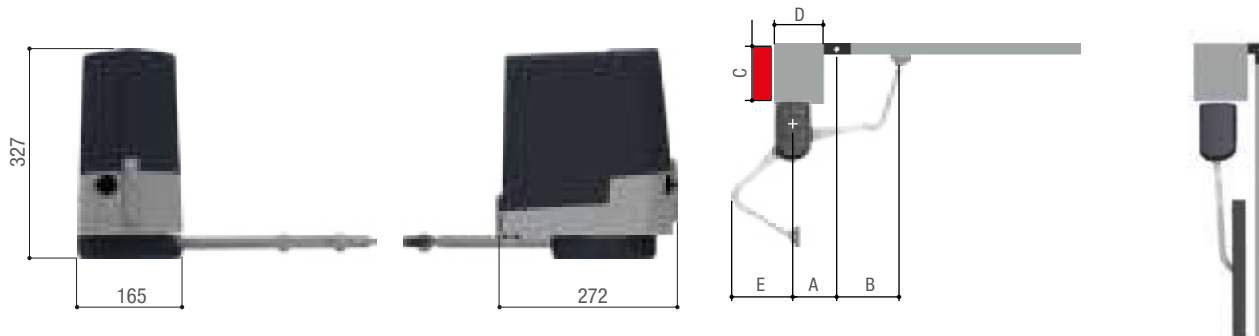

### Application dimensions (mm)

MODELS	801MB-0080 · 801MB-0050				
LEAF OPENING (°)	A	B	D	E	C Max.
90	140	420 (490 with item 801XC-0070)	Min. 150	310 (410 with item 801XC-0070)	150 (300 with item 801XC-0070)
90	160 ÷ 180	380 (460 with item 801XC-0070)	Min. 150	310 (410 with item 801XC-0070)	150 (300 with item 801XC-0070)
110	200 ÷ 220	400 (470 with item 801XC-0070)	Min. 150	310 (410 with item 801XC-0070)	50 (300 with item 801XC-0070)

### Operational limits

MODELS	801MB-0080 · 801MB-0050		
Max. length of leaf (m)	2	1,7	1
Max. weight of leaf (kg)	200	225	250
Max. leaf opening (°)		110	

### Technical characteristics

MODELS	801MB-0080	801MB-0050
Protection rating (IP)	44	44
Power supply (V - 50/60 Hz)	230 AC	-
Power supply to motor (V)	24 DC	24 DC
Absorption (A)	4 Max.	4 Max.
Power (W)	140	140
Maneuvering time at 90° (s)	from 19 to 25	from 20 to 30
Cycles/Hour	40	40
Thrust (N)	180	180
Operating temperature (°C)	-20 ÷ +55	-20 ÷ +55

## Code Description

### Complete operators with 24 V DC gearmotors, tested in compliance with regulatory standards EN 12453

**801MB-0080**



FTL20DGC - Irreversible 24 V gearmotor featuring a control board with dip-switch settings, on-board radio decoding with C Max. 150 mm for swing gates with up to 2 m leaves that weighs up to 200 kg. RAL7024-grey cover.



### 24 V DC gearmotors, tested in compliance with regulatory standards EN 12453

**801MB-0050**



FTL20DGS - Irreversible 24 V operator with hinged transmission arm for swing gates with Max. C of 150 mm with leaves up to 2 m long that weighs up to 200 kg. RAL7024-grey cover.



### Accessories for: 801MB-0080

001**RGP1**

Green Power module to disconnect the transformer for energy saving while the operator is not in use.



001**R800**

Control board for decoding and access-control management via keypad selectors.



### Accessories for: 801MB-0080

002**RLB**

Circuit board for emergency operation and battery charging.



### Accessories

001**STYLO-BD**

Straight drive arm and track with mechanical opening limit-switch.



**801XC-0070**

Hinged arm for increasing to 250 mm the maximum C-distance.



## EASY RELEASE!

In emergencies or during power outages, the key-activated release is quick to get to and easy to use. The handy lever releases the gearmotor for manually opening the gate.

MAXIMUM LEAF LENGTH	MAXIMUM LEAF WEIGHT	USE	C MAX.
UP TO 2 m	UP TO 250 kg	40 CYCLES/HOUR	300 mm

### Solution for applying in private homes and apartment buildings, on small and medium-sized gate posts

- Encoder-based movement control.
- Control board with terminal blocks, display and storage for up to 250 users.
- Ready for operation in case of power outage.
- Self-diagnosing safety devices.
- User-friendly release lever for manually opening the gate.
- Developed with CONNECT technology for remote digital control via gateway or locally via GAME KEY.



### Dimensions (mm)

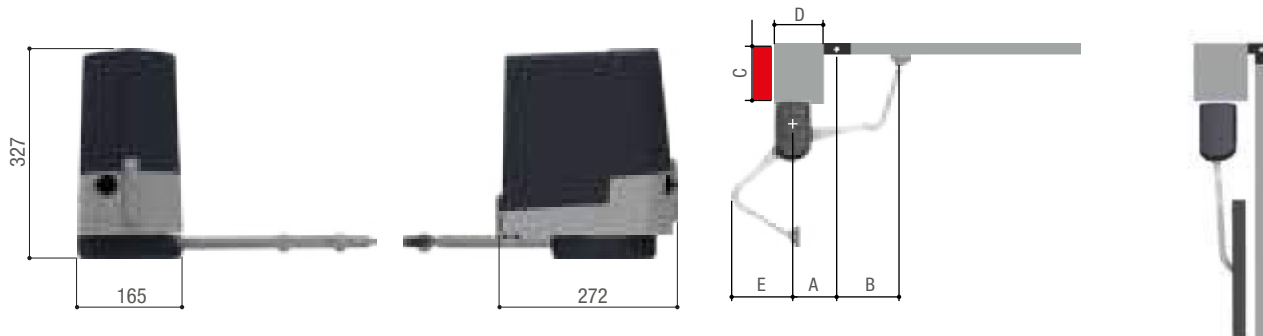

### Application dimensions (mm)

MODELS					801MB-0130 · 801MB-0140	801MB-0150 · 801MB-0160
LEAF OPENING (°)	A	B	D	E	C Max.	C Max.
90	140	420 (490 with item 801XC-0070)	Min. 150	310 (410 with item 801XC-0070)	150 (300 with item 801XC-0070)	250 (300 with item 801XC-0070)
90	160 ÷ 180	380 (460 with item 801XC-0070)	Min. 150	310 (410 with item 801XC-0070)	150 (300 with item 801XC-0070)	250 (300 with item 801XC-0070)
110	200 ÷ 220	400 (470 with item 801XC-0070)	Min. 150	310 (410 with item 801XC-0070)	50 (300 with item 801XC-0070)	50 (300 with item 801XC-0070)

### Operational limits

MODELS	801MB-0130 · 801MB-0140 · 801MB-0150 · 801MB-0160				
Max. length of leaf (m)		2	1,7	1,5	1
Max. weight of leaf (kg)		200	225	230	250
Max. leaf opening (°)				110	

### Technical characteristics

MODELS	801MB-0130	801MB-0150	801MB-0140	801MB-0160
Protection rating (IP)	44	44	44	44
Power supply (V - 50/60 Hz)	230 AC	230 AC	230 AC	230 AC
Power supply to motor (V)	24 DC	24 DC	24 DC	24 DC
Absorption (A)	4 Max.	4 Max.	4 Max.	4 Max.
Power (W)	140	140	140	140
Maneuvering time at 90° (s)	13 ÷ 30	13 ÷ 30	13 ÷ 30	13 ÷ 30
Cycles/Hour	40	40	40	40
Thrust (N)	180	180	180	180
Operating temperature (°C)	-20 ÷ +55	-20 ÷ +55	-20 ÷ +55	-20 ÷ +55

Code	Description
<b>Complete operators with 24 V DC gearmotors, tested in compliance with regulatory standards EN 12453</b>	
<b>801MB-0130</b> 	FTX20DGC - Irreversible 24 V operator, fast version, complete with control board with functions display, on-board radio decoding and hinged transmission arm for swing gates with Max. C of 150 mm with leaves up to 2 m long that weighs up to 200 kg. RAL7024-gray cover.
<b>801MB-0150</b> 	FTX20DLC - Irreversible 24 V operator, fast version, complete with control board with functions display, on-board radio decoding and hinged transmission arm for swing gates with Max. C of 250 mm with leaves up to 2 m long that weighs up to 200 kg. RAL7024-gray cover.
<b>24 V DC gearmotors, tested in compliance with regulatory standards EN 12453</b>	
<b>801MB-0140</b> 	FTX20DGS - Irreversible 24 V operator, fast version, with hinged transmission arm for swing gates with Max. C of 150 mm with leaves up to 2 m long that weighs up to 200 kg. RAL7024-gray cover.
<b>801MB-0160</b> 	FTX20DLS - Irreversible 24 V operator, fast version, with hinged transmission arm for swing gates with Max. C of 250 mm with leaves up to 2 m long that weighs up to 200 kg. RAL7024-gray cover.
<b>Control panels running on 24 V DC tested in compliance with standards EN 12453</b>	
<b>002ZL65</b> 	Control panel for one or two-leaf swing gates, with programming display, self-diagnosing safety devices and on-board radio decoding.
<b>801QA-0050</b> 	ZLX24MA - Multifunctional control panel, with 230 V AC power supply, for 24 V double-leaf gates, with programming and signaling display, self-diagnosis of safety devices, Adaptive Speed & Torque Technology, CXN BUS, 2 safety inputs and storage for up to 250 users.
<b>801QA-0060</b> 	ZLX24SA - Multifunctional control panel, with 230 V AC power supply, for 24 V double-leaf gates, with programming and graphical signaling display, self-diagnosis of safety devices, Adaptive Speed & Torque Technology, CXN BUS, 4 safety inputs and storage for up to 1000 users.



## WE CONNECT. YOU CONTROL.

Cloud connectivity changes how we experience operators. This technology revamps our lifestyles, to ensure comfort and safety. CAME CONNECT make all our products available on the web where you can manage and control them from smartphones and tablets. Download CAME AUTOMATION APP from Google play or App Store.



## EASY RELEASE!

In emergencies or during power outages, the key-activated release is quick to get to and easy to use. The handy lever releases the gearmotor for manually opening the gate.

# THE COMPLETE RANGE

## Code Description

### Accessories for complete automations: 801MB-0130 - 801MB-0150

001 <b>RGP1</b>	Green Power module to disconnect the transformer for energy saving while the operator is not in use.
002 <b>RSE</b>	Interface card for controlling two operators or for enabling the Came Remote Protocol.
001 <b>R700</b>	Control board for decoding and access-control management via transponder selector.
001 <b>R800</b>	Control board for decoding and access-control management via keypad selectors.

### 24 V accessories for complete operators: 801MB-0130 - 801MB-0150

002 <b>RLB</b>	Circuit board for emergency operation and battery charging.
----------------	---



### CXN BUS interface for: 801QA-0050 - 801QA-0060

806 <b>XG-0080</b>	BUS expansion module with 2 inputs and 2 outputs. Inputs can be configured in NO, NC or resistive mode (8K2), a warning light output and a relay output.
--------------------	--



### Accessories

001 <b>LOCK81</b>	Single cylinder electric lock.
001 <b>LOCK82</b>	Double cylinder electric lock.
001 <b>STYLO-BD</b>	Straight drive arm and track with mechanical opening limit-switch.
001 <b>H3000</b>	Case for remote release with customized key, plus pull-cord handle and control button. Cord length L = 5 m.
001 <b>RSWN001</b>	Pull-cord remote release device for operators.





# BKV

**EFFICIENT AND ROBUST FOR  
LARGE GATES**

FIND OUT MORE ON PAGE 60

**CAME** 

[CAME.COM](https://www.came.com)

# FAST 70

SWING GATE AUTOMATION



MAXIMUM LEAF LENGTH	MAXIMUM LEAF WEIGHT	USE	C MAX.
UP TO 2.3 m	UP TO 300 kg	30%	300 mm

## Solution for applying in private homes and apartment buildings, on medium and large-sized gate posts



- Control board with terminal blocks, dip switches and storage for up to 1000 users.
- Ready for operation in case of power outage.
- Self-diagnosing safety devices.
- Also available in 230 V AC version with technical specifications other those indicated above.
- Developed with CONNECT technology for remote digital control via gateway or locally via CAME KEY.

### Dimensions (mm)

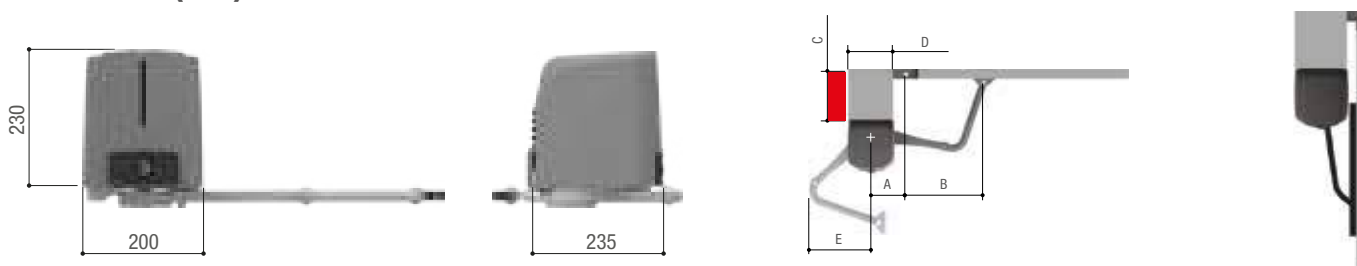

### Application dimensions (mm)

MODELS	FA70230CB · FA70230 · FA7024CB · FA7024					801MB-0090 · 801MB-0100				
	A	B	D	E	C Max.	A	B	D	E	C Max.
90	140	420 (490*)	Min. 200	260 (350*)	200 (300*)	140	490	Min. 200	410	300
90	160	380 (460*)	Min. 220	240 (320*)	200 (300*)	160	460	Min. 220	410	300
90	180	380 (460*)	Min. 240	240 (320*)	200 (300*)	180	460	Min. 240	410	300
110	220	380 (450*)	Min. 280	310 (400*)	50 (50*)	220	470	Min. 280	410	50
110	240	380 (450*)	Min. 300	310 (400*)	50 (50*)	240	470	Min. 300	410	50

\* with item 801XC-0070

### Operational limits

MODEL	FA70230CB · FA70230 · FA7024CB · FA7024 · 801MB-0090 · 801MB-0100			
Max. width of leaf (m)	2,3	2	1,5	1
Max. weight of leaf (kg)	200	215	250	300
Max. leaf opening (°)	110			

### Technical characteristics

MODELS	FA70230CB	FA70230	FA7024CB	FA7024	801MB-0090	801MB-0100
Protection rating (IP)	54	54	54	54	54	54
Power supply (V - 50/60 Hz)	230 AC	230 AC	230 AC	-	230 AC	-
Power supply to motor (V)	230 AC	230 AC	24 DC	24 DC	24 DC	24 DC
Absorption (A)	1,4	1,4	-	-	-	-
Power (W)	160	160	140	140	140	140
Maneuvering time at 90° (s)	15	15	13 ÷ 30	13 ÷ 30	13 ÷ 30	13 ÷ 30
Duty/cycle (%)	30	30	-	-	-	-
Cycles/Hour	-	-	65	65	65	65
Operating temperature (°C)	-20 ÷ +55	-20 ÷ +55	-20 ÷ +55	-20 ÷ +55	-20 ÷ +55	-20 ÷ +55
Motor's heat protection (°C)	150	150	-	-	-	-

● 230 V AC ● 24 V DC

## Code Description

### 230 V AC automated operators

001**FA70230CB** Irreversible 230 V gearmotor featuring a control board and hinged transmission arm with C Max. 200 mm for swing gates with up to 2.3 m leaves that weighs up to 200 kg.



### 230 V AC Gearmotors

001**FA70230** Irreversible 230 V gearmotor with hinged transmission arm and C Max. 200 mm for swing gates with up to 2.3 m leaves that weighs up to 200 kg.



### Automated operators running on 24 V DC with max. C-distance of 200 mm tested in compliance with standards EN 12453

001**FA7024CB** Irreversible 24 V gearmotor featuring a control board with functions display, on-board radio decoding and hinged transmission arm with C Max. 200 mm for swing gates with up to 2.3 m leaves that weighs up to 200 kg.



### Gearmotors running on 24 V DC with max. C-distance of 200 mm tested in compliance with standards EN 12453

001**FA7024** Irreversible 24 V gearmotor with hinged transmission arm and C Max. 200 mm for swing gates with up to 2.3 m leaves that weighs up to 200 kg.



### Automated operators running on 24 V DC with max. C-distance of 300 mm tested in compliance with standards EN 12453

**801MB-0090** FST23DLC - Irreversible 24 V gearmotor featuring a control board with functions display, on-board radio decoding and hinged transmission arm with C Max. 300 mm for swing gates with up to 2.3 m leaves that weighs up to 200 kg.



### Gearmotors running on 24 V DC with max. C-distance of 300 mm tested in compliance with standards EN 12453

**801MB-0100** FST23DLS - Irreversible 24 V gearmotor with hinged transmission arm and C Max. 300 mm for swing gates with up to 2.3 m leaves that weighs up to 200 kg.



### Control panels running on 24 V DC tested in compliance with standards EN 12453

002**ZL65** Control panel for one or two-leaf swing gates, with programming display, self-diagnosing safety devices and on-board radio decoding.



**801QA-0050** ZLX24MA - Multifunctional control panel, with 230 V AC power supply, for 24 V double-leaf gates, with programming and signaling display, self-diagnosis of safety devices, Adaptive Speed & Torque Technology, CXN BUS, 2 safety inputs and storage for up to 250 users.



**801QA-0060** ZLX24SA - Multifunctional control panel, with 230 V AC power supply, for 24 V double-leaf gates, with programming and graphical signaling display, self-diagnosis of safety devices, Adaptive Speed & Torque Technology, CXN BUS, 4 safety inputs and storage for up to 1000 users.



# THE COMPLETE RANGE

## Code Description

### Accessories for: 002ZL65

001 <b>RGP1</b>	Green Power module to disconnect the transformer for energy saving while the operator is not in use.
001 <b>R700</b>	Control board for decoding and access-control management via transponder selector.
001 <b>R800</b>	Control board for decoding and access-control management via keypad selectors.
002 <b>RSE</b>	Interface card for controlling two operators or for enabling the Came Remote Protocol.



### Accessori per: 002ZL65 - 801QA-0050 - 801QA-0060

002 <b>RLB</b>	Circuit board for emergency operation and battery charging.
----------------	---

24



### Accessories for: 002RLB

001 <b>LBF70</b>	Batteries brace kit.
------------------	----------------------



### CXN BUS interface for: 801QA-0050 - 801QA-0060

806 <b>XG-0080</b>	BUS expansion module with 2 inputs and 2 outputs. Inputs can be configured in NO, NC or resistive mode (8K2), a warning light output and a relay output.
--------------------	--

CXN



### Accessories

001 <b>STYLO-BD</b>	Straight drive arm and track with mechanical opening limit-switch.
---------------------	--



001 <b>LOCK81</b>	Single cylinder electric lock.
-------------------	--------------------------------



001 <b>LOCK82</b>	Double cylinder electric lock.
-------------------	--------------------------------



001 <b>H3000</b>	Case for remote release with customized key, plus pull-cord handle and control button. Cord length L = 5 m.
------------------	---



NOTES:  
002RLB - Two 12 V - 3.4 Ah batteries - not supplied - on the 001FA7024 the internal housing is included.



# ATS

**THE UNIVERSAL  
TELESCOPIC MOTOR  
FOR SWING GATES**

FIND OUT MORE ON PAGE 76

**CAME** 

[CAME.COM](https://www.came.com)

MAXIMUM LEAF LENGTH	MAXIMUM LEAF WEIGHT	USE	C MAX.
UP TO 4 m	UP TO 800 kg	INTENSIVE USE	380 mm

### Solution for applying in private homes and apartment buildings, on large-sized gate posts

- Encoder-based movement control.
- Solid anodized aluminium cover.
- Straight transmission arms for applications in limited space (item 001FERNI-BDX - 001FERNI-BSX).
- Lever release system protected by key.
- Developed with CONNECT technology for remote digital control via gateway or locally via CAME KEY.



### Dimensions (mm)

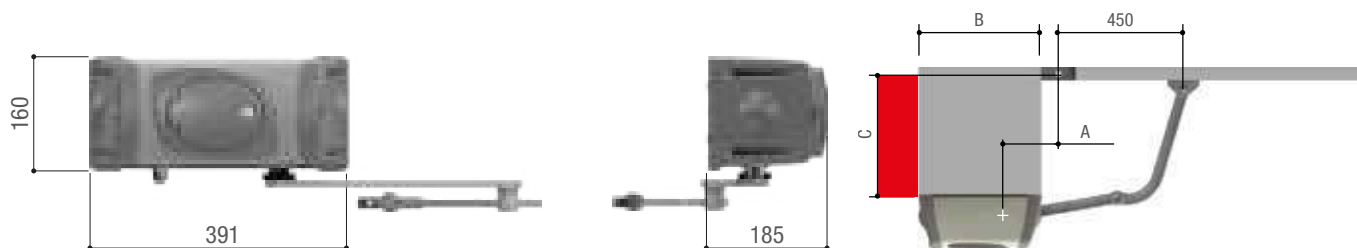

### Application dimensions (mm)

MODELS	FE40230 · FE40230V · FE4024 · FE4024V		
LEAF OPENING (°)	A	B min.	C Max.
90	150	390	380
120	200	390	0

### Operational limits

MODEL	FE40230 · FE40230V · FE4024 · FE4024V				
Max. width of leaf (m)	4	3.5	3	2.5	2
Max. weight of leaf (kg)	400	450	500	600	800
Max. leaf opening (°)	120				

MODEL	FE4024 (with the 001FERNI-BDX and 001FERNI-BSX drive arm)		
Max. width of leaf (m)	2,5	2	1,5
Max. weight of leaf (kg)	300	500	500
Max. leaf opening (°)	120		

### Technical characteristics

MODELS	FE40230	FE40230V	FE4024	FE4024V
Protection rating (IP)	44	44	44	44
Power supply (V - 50/60 Hz)	230 AC	230 AC	-	-
Power supply to motor (V)	230 AC 50/60 Hz	230 AC 50/60 Hz	24 DC	24 DC
Absorption (A)	1,2	1,3	7 Max.	5 Max.
Power (W)	140	150	130	150
Maneuvering time at 90° (s)	34	18	ADJUSTABLE	ADJUSTABLE
Duty/cycle (%)	30	30	HEAVY-DUTY SERVICE	HEAVY-DUTY SERVICE
Thrust (N)	540	320	360	360
Operating temperature (°C)	-20 ÷ +55	-20 ÷ +55	-20 ÷ +55	-20 ÷ +55
Motor's heat protection (°C)	150	150	-	-

Code	Description
<b>230 V AC Gearmotors</b>	
001 <b>FE40230V</b> 	Irreversible 230 V gearmotor, rapid version, with hinged transmission arm and C Max. 380 mm for swing gates with with up to 4 m leaves that weighs up to 400 kg.
<b>230 V AC gearmotors tested in compliance with regulatory standards EN 12453</b>	
001 <b>FE40230</b> 	Irreversible 230 V gearmotor with hinged transmission arm and C Max. 380 mm for swing gates with with up to 4 m leaves that weighs up to 400 kg.
<b>Control panels for 230 V AC gearmotors</b>	
002 <b>ZM3E</b> 	Multifunction control panel for swing gates with two leaves, graphic programming and alerts display, plus self-diagnosing safety devices and on-board radio decoding.
<b>24 V DC gearmotors, tested in compliance with regulatory standards EN 12453</b>	
001 <b>FE4024</b> 	Irreversible 24 V gearmotor, with hinged transmission arm and C Max. 380 mm for swing gates with up to 4 m leaves that weighs up to 400 kg.
001 <b>FE4024V</b> 	Irreversible 24 V gearmotor, rapid version, with hinged transmission arm and C Max. 380 mm for swing gates with up to 4 m leaves that weighs up to 400 kg.
<b>Control panels for 24 V gearmotors, tested in compliance with regulatory standards EN 12453</b>	
801 <b>QA-0050</b> 	ZLX24MA - Multifunctional control panel, with 230 V AC power supply, for 24 V double-leaf gates, with programming and signaling display, self-diagnosis of safety devices, Adaptive Speed & Torque Technology, CXN BUS, 2 safety inputs and storage for up to 250 users.
801 <b>QA-0060</b> 	ZLX24SA - Multifunctional control panel, with 230 V AC power supply, for 24 V double-leaf gates, with programming and graphical signaling display, self-diagnosis of safety devices, Adaptive Speed & Torque Technology, CXN BUS, 4 safety inputs and storage for up to 1000 users.
<b>Accessori per: 801QA-0050 - 801QA-0060</b>	
002 <b>RLB</b> 	Circuit board for emergency operation and battery charging.
<b>CXN BUS interface for: 801QA-0050 - 801QA-0060</b>	
806 <b>XG-0080</b> 	BUS expansion module with 2 inputs and 2 outputs. Inputs can be configured in NO, NC or resistive mode (8K2), a warning light output and a relay output.
<b>Accessories for: 001FE40230 - 001FE4024 - 001FE40230V - 001FE4024V</b>	
001 <b>FERNI-BDX</b>	Straight right-hand drive arm and track.
001 <b>FERNI-BSX</b>	Straight left-hand drive arm and track.
<b>Accessories</b>	
001 <b>LOCK81</b>	Single cylinder electric lock.
001 <b>LOCK82</b>	Double cylinder electric lock.
001 <b>H3000</b>	Case for remote release with customized key, plus pull-cord handle and control button. Cord length L = 5 m.



NOTES:  
WARNING: 001FE40230V + 002ZM3E are not tested in compliance with standards EN12453 - EN 12445.

MAXIMUM LEAF LENGTH	MAXIMUM LEAF WEIGHT	USE	TYPES
UP TO 3.5 m	UP TO 800 kg	INTENSIVE USE	BELOW-GROUND

### Concealed solution for applying in private homes or apartment buildings



- The invisible solution to power your gate
- Protection rating against weathering agents IP67.
- Foundation box in steel with anticorrosive treatment, or in AISI 304 stainless steel.
- System automatically resets after the gate is manually released.
- Integrated, adjustable mechanical limit switches.
- Opening up to 180° (with FL-180 accessory).
- Ready for operation in case of power outage in the 24 V DC versions.
- Developed with CONNECT technology for remote digital control via gateway or locally via CAME KEY.

### Dimensions (mm)

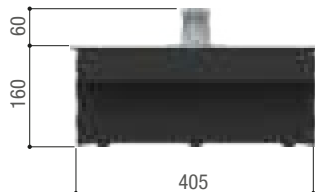
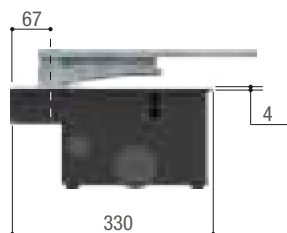

A = Min. 67

### Operational limits

MODEL	FROG-AV			
Max. width of leaf (m)	1,3			
Max. weight of leaf (kg)	300			
MODEL	FROG-A · FROG-AE			
Max. width of leaf (m)	3,5	2,5	2	-
Max. weight of leaf (kg)	400	600	800	-
MODEL	FROG-A24 · FROG-A24E			
Max. width of leaf (m)	3,5	2,5	2	-
Max. weight of leaf (kg)	400	600	800	-
Max. leaf opening (°)	110			

### Technical characteristics

MODELS	FROG-AE	FROG-A	FROG-AV	FROG-A24	FROG-A24E
Protection rating (IP)	67	67	67	67	67
Power supply (V - 50/60 Hz)	230 AC	230 AC	230 AC	-	-
Power supply to motor (V)	230 AC	230 AC	230 AC	24 DC	24 DC
Absorption (A)	1,9	1,9	2,5	15 Max.	15 Max.
Power (W)	460	460	300	180	180
Maneuvering time at 90° (s)	18	18	9	ADJUSTABLE	ADJUSTABLE
Duty/cycle (%)	30	30	30	HEAVY-DUTY SERVICE	HEAVY-DUTY SERVICE
Cycles/Hour	11	11	-	-	-
Operating temperature (°C)	-20 ÷ +55	-20 ÷ +55	-20 ÷ +55	-20 ÷ +55	-20 ÷ +55
Motor's heat protection (°C)	150	150	150	-	-

● 230 V AC ● 24 V DC

Code	Description
<b>230 V AC below-ground gearmotors</b>	
001 <b>FROG-A</b>	Irreversible underground 230 V gearmotor with adjustable leaf-closing for swing gates with up to 3.5 m leaves that weighs up to 400 kg.
001 <b>FROG-AV</b>	Irreversible underground 230 V gearmotor, rapid version, with adjustable leaf-closing for swing gates with up to 1.3 m leaves that weighs up to 300 kg.
<b>Control panels for 230 V AC gearmotors</b>	
002 <b>ZA3P</b>	Multifunction control panel for two-leaved swing gates, with limit-switch control and slow-down speed adjusting.
<b>Below-ground 230 V AC gearmotors, tested in compliance with regulatory standards EN 12453</b>	
001 <b>FROG-AE</b> 	Irreversible underground 230 V gearmotor with encoder and adjustable leaf-closing for swing gates with up to 3.5 m leaves that weighs up to 400 kg.
<b>Control panels for 230 V AC gearmotors, tested in compliance with regulatory standards EN 12453</b>	
002 <b>ZM3E</b> 	Multifunction control panel for swing gates with two leaves, graphic programming and alerts display, plus self-diagnosing safety devices and on-board radio decoding.
<b>Below-ground 24 V DC operators</b>	
001 <b>FROG-A24</b> 	Irreversible underground 24 V gearmotor with adjustable leaf-closing for swing gates with up to 3.5 m leaves that weighs up to 400 kg.
<b>Below-ground, 24 V DC operators, tested in compliance with regulatory standards EN 12453</b>	
001 <b>FROG-A24E</b> 	Irreversible underground 24 V gearmotor with adjustable leaf-closing for swing gates with up to 3.5 m leaves that weighs up to 400 kg.
<b>Control panels for 24 V gearmotors</b>	
801 <b>QA-0050</b> 	ZLX24MA - Multifunctional control panel, with 230 V AC power supply, for 24 V double-leaf gates, with programming and signaling display, self-diagnosis of safety devices, Adaptive Speed & Torque Technology, CXN BUS, 2 safety inputs and storage for up to 250 users.
801 <b>QA-0060</b> 	ZLX24SA - Multifunctional control panel, with 230 V AC power supply, for 24 V double-leaf gates, with programming and graphical signaling display, self-diagnosis of safety devices, Adaptive Speed & Torque Technology, CXN BUS, 4 safety inputs and storage for up to 1000 users.
<b>Accessori per: 801QA-0050 - 801QA-0060</b>	
002 <b>RLB</b> 	Circuit board for emergency operation and battery charging.
<b>CXN BUS interface for: 801QA-0050 - 801QA-0060</b>	
806 <b>XG-0080</b> 	BUS expansion module with 2 inputs and 2 outputs. Inputs can be configured in NO, NC or resistive mode (8K2), a warning light output and a relay output.



# THE COMPLETE RANGE

Code	Description
Accessories for: 001FROG-A - 001FROG-AV - 001FROG-AE - 001FROG-A24E	
001 <b>FL-180</b>	Drive chain lever for up to 180° openings and gate leaves of max. 2 m in length.
Accessories	
001 <b>FROG-CFNI</b>	AISI 304 steel foundation box, complete with release latching-lever, gate fastening brace, slots for fastening to post, and screw for adjusting the opening limit-switch point.
001 <b>FROG-CFN</b>	Stainless steel, cataphoresis treated foundation box, featuring release transmission, gate fastening brace, slots for fastening to post, and spring for adjusting the opening limit-switch point.
001 <b>LOCK81</b>	Single cylinder electric lock.
001 <b>LOCK82</b>	Double cylinder electric lock.
001 <b>A4364</b>	Release device with lever key.
001 <b>A4365</b>	Release device with trilobe key.
<b>801XA-0030</b>	Release device with customized key and EURO-DIN cylinder.
001 <b>A4370</b>	Transmission lever for openings up to 140°.



NOTES:  
001FL-180 - 001A4370 - Accessories for 2-m long gate leaves.



# KRX

## THE NEW FRONTIER OF FLASHING LIGHTS

FIND OUT MORE ON PAGE 226

**CAME** 

[CAME.COM](http://CAME.COM)



# FROG PLUS

SWING GATE AUTOMATION



MAXIMUM LEAF LENGTH	MAXIMUM LEAF WEIGHT	USE	TYPES
UP TO 7 m	UP TO 1000 kg	10 CYCLES/HOUR	BELOW-GROUND

## Concealed solution for applying in private homes or apartment buildings

- The invisible solution to power your gate
- Protection rating against weathering agents IP67.
- Equipped with encoder.
- Integrated, adjustable mechanical limit switches.
- System automatically resets after the gate is manually released.
- Developed with CONNECT technology for remote digital control via gateway or locally via CAME KEY.



## Dimensions (mm)

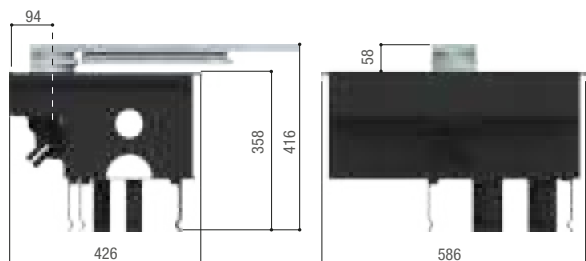

A = Min. 94

## Operational limits

MODEL	FROG-PM4				
Max. width of leaf (m)	5,5	4,5	3,5	2,5	1,5
Max. weight of leaf (kg)	700	900	1100	1400	1800
MODEL	FROG-PM6				
Max. width of leaf (m)	7	6	5	4	
Max. weight of leaf (kg)	550	650	800	1000	
Max. leaf opening (°)	110				

## Technical characteristics

MODELS	FROG-PM4	FROG-PM6
Protection rating (IP)	67	67
Power supply (V - 50/60 Hz)	230 AC	230 AC
Power supply to motor (V)	230 AC	230 AC
Absorption (A)	2,1	2,1
Power (W)	500	500
Maneuvering time at 90° (s)	30	45
Cycles/Hour	10	6
Operating temperature (°C)	-20 ÷ +55	-20 ÷ +55
Motor's heat protection (°C)	150	150

● 230 V AC

Code	Description
<b>230 V AC below-ground gearmotors</b>	
001 <b>FROG-PM4</b> 	Irreversible underground 230 V gearmotor with encoder and adjustable leaf-closing for swing gates with up to 5.5 m leaves that weighs up to 700 kg.
001 <b>FROG-PM6</b> 	Irreversible underground 230 V gearmotor with encoder and adjustable leaf-closing for swing gates with up to 7 m leaves that weighs up to 550 kg.
<b>Control panels for 230 V AC gearmotors</b>	
002 <b>ZM3EP</b> 	Multifunction control panel for swing gates with two leaves, graphic programming and alerts display, plus self-diagnosing safety devices and on-board radio decoding.
<b>Accessories</b>	
001 <b>FROG-PC</b>	Steel, cataphoresis treated foundation box, featuring release transmission, gate fastening brace and spring for adjusting the opening limit-switch point.
001 <b>A4801</b>	Micro limit-switch IP67 designed for applications in critical climatic conditions.
001 <b>A4364</b>	Release device with lever key.
001 <b>A4365</b>	Release device with trilobe key.
<b>801XA-0030</b>	Release device with customized key and EURO-DIN cylinder.
001 <b>LOCK81</b>	Single cylinder electric lock.
001 <b>LOCK82</b>	Double cylinder electric lock.



# SUPER FROG

SWING GATE AUTOMATION



MAXIMUM LEAF LENGTH	MAXIMUM LEAF WEIGHT	USE	TYPES
UP TO 8 m	UP TO 1500 kg	50%	BELOW-GROUND

## Concealed solution for special applications

- The invisible solution to power your gate
- Power supply 230 - 400 V AC triphase to offer maximum performance
- Protection rating against weathering agents IP67.
- Integrated, adjustable mechanical limit switches.
- Developed with CONNECT technology for remote digital control via gateway or locally via CAME KEY.



## Dimensions (mm)

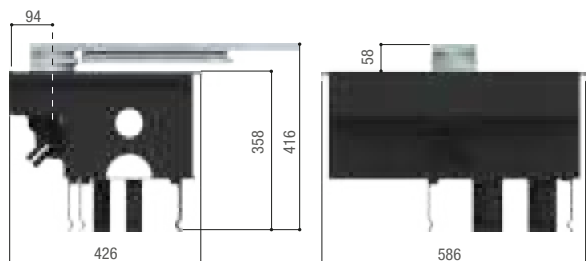

A = Min. 100

## Operational limits

MODEL	FROG-MD · FROG-MS					
Max. width of leaf (m)	8	7	6	5	4	< 4
Max. weight of leaf (kg)	600	700	800	1000	1200	1500
Max. leaf opening (°)	95					

## Technical characteristics

MODELS	FROG-MD	FROG-MS
Protection rating (IP)	67	67
Power supply (V - 50/60 Hz)	230/ 400 V AC THREE PHASE	230/ 400 V AC THREE PHASE
Power supply to motor (V)	230/ 400 V AC THREE PHASE	230/ 400 V AC THREE PHASE
Absorption (A)	2.5 max.	2.5 max.
Power (W)	600	600
Maneuvering time at 90° (s)	45	45
Duty/cycle (%)	50	50
Operating temperature (°C)	-20 ÷ +55	-20 ÷ +55

● 230 – 400 V AC THREE PHASE

Code	Description
<b>230 - 400 V AC three-phase below-ground gearmotors</b>	
001 <b>FROG-MD</b> 	Right-side irreversible underground 230 - 400 V gearmotor for swing gates with up to 8 m leaves that weighs up to 600 kg.
001 <b>FROG-MS</b> 	Left-side irreversible underground 230 - 400 V gearmotor for swing gates with up to 8 m leaves that weighs up to 600 kg.
<b>230 - 400 V AC three-phase control panels</b>	
002 <b>ZM3ES</b> 	Multifunction control panel for swing gates with two leaves, graphic programming and alerts display, and self-diagnosing safety devices.
<b>Foundation box</b>	
001 <b>FROG-CD</b>	Right-hand, steel cataphoresis-treated, foundation-casing, complete with release latching-lever, gate-fastening brace and mechanical stop.
001 <b>FROG-CS</b>	Left-hand, steel cataphoresis-treated, foundation-casing, complete with release latching-lever, gate-fastening brace and mechanical stop.



# CONTROL PANEL DIMENSIONS

## Dimensions (mm)

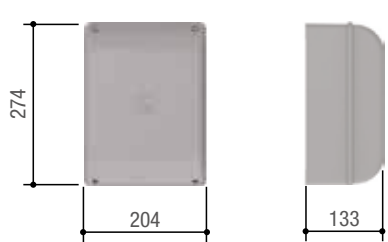

002ZA3P  
002ZL65  
002ZL60

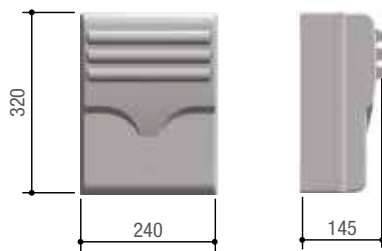

002ZM3E  
002ZM3EP  
002LB18

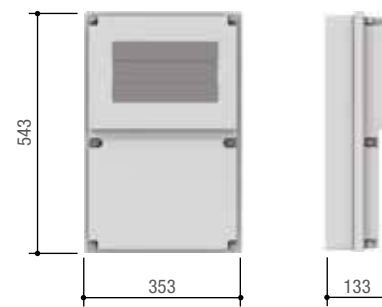

002ZM3ES

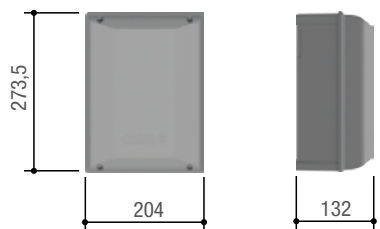

801QA-0050

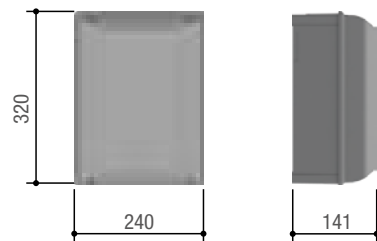

801QA-0060



The table lists all of the characteristics of swing-gate control panels. The ones in bold type are important for choosing which operator to install and should be assessed from the start.

	+24 -	+24 -					+24 -	+24 -
<b>Models / Series</b>	ATS STYLO FAST70 AXI FERNI AXO ATI FROG	ATS STYLO FAST70 AXI FERNI AXO ATI FROG	ATS ATI KRONO FROG FAST70 FERNI	ATS AXO FERNI FROG	FROG PLUS	SUPER FROG	ATS AXI FTX FAST70	AXL FTL
<b>Control board / Control panel</b>	8010A-0050	8010A-0060	ZA3P	ZM3E	ZM3EP	ZM3ES	ZL65	ZL60
<b>Safety</b>								
SELF-DIAGNOSING safety decives	●	●	●	●	●	●	●	●
PRE-FLASHING when opening and closing	●	●	●	●	●	●	●	●
REOPENING during closing	●	●	●	●	●	●	●	●
CLOSING AGAIN during opening	●	●	●	●	●	●	●	●
Obstruction WAIT	●	●	●	●	●	●	●	●
TOTAL STOP	●	●	●	●	●	●	●	●
PARTIAL STOP	●	●	●	●	●	●	●	●
REOPENING when closing and with immediate closing once the obstruction is removed	●	●						
OBSTRUCTION DETECTION in front of photocells	●	●	●	●	●	●	●	●
ENCODER	●	●		●	●		●	●
Virtual ENCODER	●	●						
AMPEROMETRIC DETECTION	●	●					●	●
<b>Command</b>								
PEDESTRIAN OPENING 1 leaf	●	●		●	●	●	●	●
PARTIAL OPENING 1 leaf	●	●	●	●	●	●	●	●
OPEN ONLY from transmitter and/or from button	●	●	●	●	●	●	●	●
ONLY OPEN or ONLY CLOSE button connection	●	●	●	●	●	●	●	●
OPEN-STOP-CLOSE-STOP from the transmitter and/or button	●	●	●	●	●	●	●	●
OPEN-CLOSE-INVERT from the transmitter and/or button	●	●	●	●	●	●	●	●
MAINTAINED ACTION	●	●	●	●	●	●	●	●
DELAYED OPENING 1st leaf	●	●	●	●	●	●	●	●
DELAYED OPENING 2nd leaf	●	●	●	●	●	●	●	●
<b>Characteristics</b>								
FLASHING LIGHT connection	●	●	●	●	●	●	●	●
CYCLE LIGHT connection	●	●	●	●	●	●	●	
COURTESY LIGHT connection	●	●	●	●	●	●	●	●
Antenna	●	●	●	●	●	●	●	●
OPEN ALERT LIGHT connection	●	●	●	●	●	●	●	●
CLOSED ALERT LIGHT connection	●	●						
Contact output for 2nd RADIO CHANNEL		●	●	●	●	●		
SELF-LEARNING of the transmitter's RADIO CODE	●	●	●	●	●	●	●	●
OPERATING TIME adjusting	●	●	●	●	●	●	●	●
Connection for the ELECTRIC LOCK and/or RAMMING	●	●	●	●	●	●	●	
SLEEP MODE				●				
Adjustable AUTOMATIC CLOSING AGAIN TIME	●	●	●	●	●	●	●	●
OPENING and/or CLOSING slow downs	●	●	●	●	●	●	●	●
EMERGENCY BATTERY operation (optional)	●	●					●	●
Adjustable TRAVEL and SLOW-DOWN speeds*	●	●	●	●	●	●	●	●
DISPLAY	●		●				●	
Graphic DISPLAY		●		●	●	●		
SELF-LEARNING opening and closing limit-switches	●	●	●	●	●	●	●	●
Compatible with CONNECT technology	●	●		●	●	●	●	
Designed to fit RIO System 2.0	●	●					●	
CRP control	●	●		●	●	●	●	
ENERGY SAVINGS control (001RGP1)	●	●		●			●	●
CXN BUS	●	●						
Adaptive Speed & Torque Technology	●	●						
Slot CAME Key	●	●						
TIMER control		●						
Possibility of managing two different motors		●						

● 230 V AC ● 24 V DC ● 230 – 400 V AC THREE PHASE

NOTES: \* 002ZA3P, 002ZM3E and 002ZM3EP only slow-down speed.

# GARAGE DOOR AUTOMATION

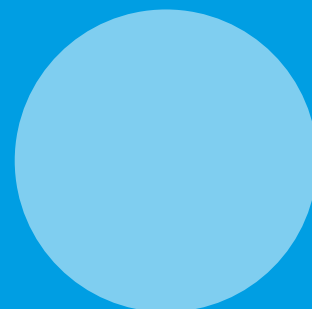

116	SELECTION GUIDE
122	VER PLUS
124	VER
126	EMEGA
129	CONTROL BOARD FUNCTIONS

# Selection guide

## Garage doors automations

The table summarizes the series and models with their maximum operational limits according to the door surface or the traction force.

Series	Model	Max. surface of the door (m <sup>2</sup> )
EMEGA	EM4024CB	9
EMEGA	EM4024CB + EM4024	14
Series	Model	Maximum traction force (N) / Maximum door surface area (m <sup>2</sup> )
VER	801MV-0050	600 / 9
VER	801MV-0060	800 / 12
VER PLUS	801MV-0010	1000 / 18
VER PLUS	801MV-0020	1300 / 21

● 24 V DC



**COUNTER-BALANCED OVERHEAD OR SPRING LOADED PARTIALLY RETRACTING DOOR**

This type of door features a counter-weighted or spring-loaded balancing system. When opening and closing the door retracts into the garage by two-thirds of its surface area.



**PROTRUDING OVERHEAD GARAGE DOOR PARTIALLY RETRACTING DOOR (WITH TWO GEARMOTORS ON THE DOOR)**

This type of door features a counter-weighted or spring-loaded balancing system. When opening and closing the door retracts into the garage by two-thirds of its surface area. The double gearmotor is fitted with insulated and/or pedestrian doors.



**COUNTER-BALANCED OVERHEAD OR SPRING LOADED**

This type of door is powered via traction system. Depending on the type of door, you will need to choose the right type of chain or belt as well as the right type of adapter arm for counter-weighted, protruding, partially-retracting overhead garage doors.



**NON-PROTRUDING, TOTALLY RETRACTING, OVERHEAD GARAGE DOOR (WITH GEARMOTOR FITTED TO DOOR)**

This type of door is balanced by counter-weights. When opening, the door fully retracts into the garage.



**SECTIONAL DOOR**

This type of door is spring-loaded for balance. It is made up of hinged, horizontal panels.

The flashing light for movement signaling.

CAME has always suggested installing the flashing light as an additional safety feature for the automation system. The KRX range, with LED technology, combines energy saving and great reliability with easy installation. KRX can be integrated with all CAME radio systems, is available in various colors, has a built-in radio antenna and each model can be powered from 24 V DC to 230 V AC.



# COUNTERBALANCED, PARTIALLY RETRACTING, OVERHEAD GARAGE DOOR



## COMPONENTS

- A** Operator (garmotor with control board)
- B** TX Photocells
- C** RX Photocells
- D** Control card for operating during power outages
- F** Flashing light
- G** Antenna
- H** Control switch  
(Key – Code – Card or transponder fob)
- K** Adapter arm
- Q** Junction box
- S** Pull-cord release device
- X** Radio frequency card

## CABLES FOR STANDARD INSTALLATIONS

LENGTH OF CABLE (m)	< 10	from 10 to 20	from 20 to 30
Power supply 230 V AC	3G x 1.5 mm <sup>2</sup>	3G x 1.5 mm <sup>2</sup>	3G x 2.5 mm <sup>2</sup>
Flashing light 24 V AC - DC	2 x 1 mm <sup>2</sup>	2 x 1 mm <sup>2</sup>	2 x 1 mm <sup>2</sup>
TX Photocells	2 x 0.5 mm <sup>2</sup>	2 x 0.5 mm <sup>2</sup>	2 x 0.5 mm <sup>2</sup>
RX Photocells	4 x 0.5 mm <sup>2</sup>	4 x 0.5 mm <sup>2</sup>	4 x 0.5 mm <sup>2</sup>
Control devices	*no. x 0.5 mm <sup>2</sup>	*no. x 0.5 mm <sup>2</sup>	*no. x 0.5 mm <sup>2</sup>
Antenna		RG58 max 10 m	

\*no. = see product mounting instructions - Attention: the cable section is merely indicative as it depends on the motor power and cable length.

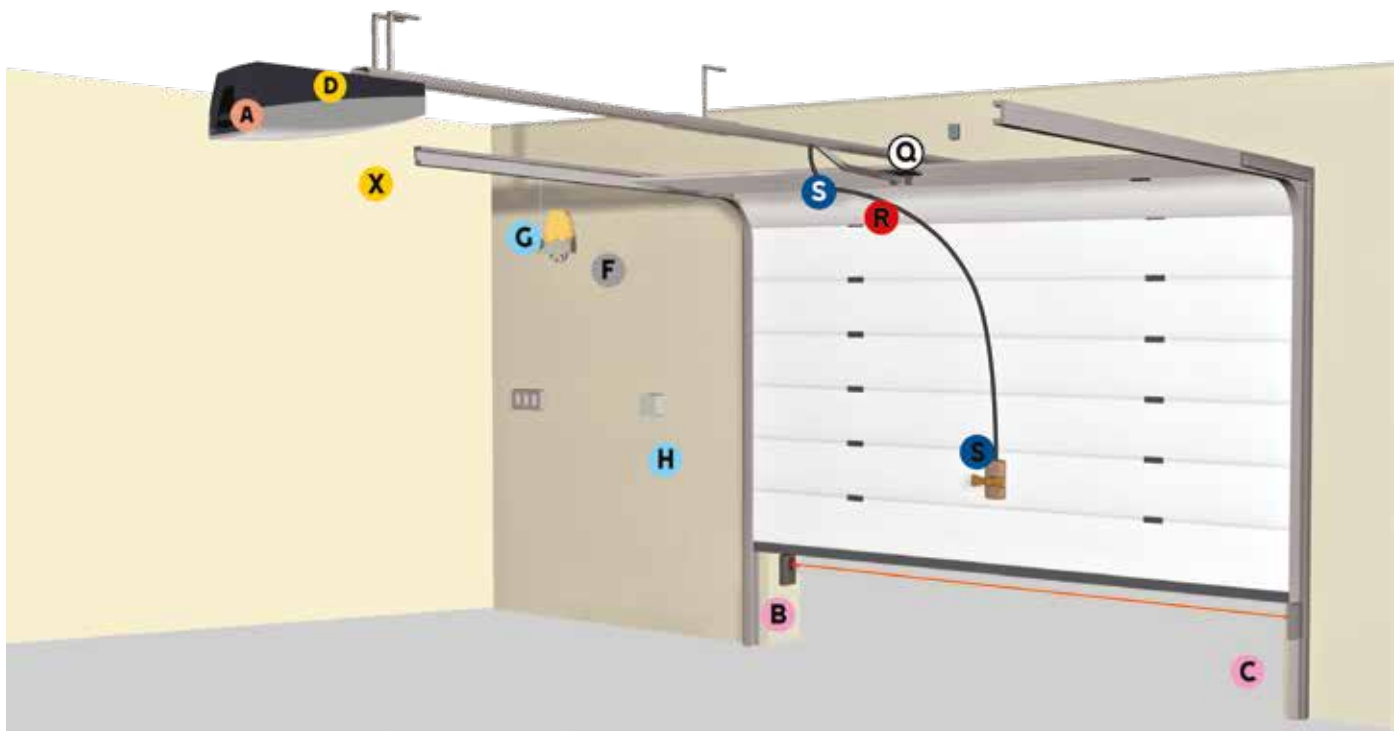

## COMPONENTS

- A** Operator (garmotor with control board)
- B** TX Photocells
- C** RX Photocells
- D** Control card for operating during power outages
- F** Flashing light
- G** Antenna
- H** Control switch  
(Key – Code – Card or transponder fob)
- Q** Junction box
- R** Drive levers
- S** Pull-cord release device
- X** Radio frequency card

## CABLES FOR STANDARD INSTALLATIONS

LENGTH OF CABLE (m)	< 10	from 10 to 20	from 20 to 30
Power supply 230 V AC	3G x 1.5 mm <sup>2</sup>	3G x 1.5 mm <sup>2</sup>	3G x 2.5 mm <sup>2</sup>
Flashing light 24 V AC - DC	2 x 1 mm <sup>2</sup>	2 x 1 mm <sup>2</sup>	2 x 1 mm <sup>2</sup>
TX Photocells	2 x 0.5 mm <sup>2</sup>	2 x 0.5 mm <sup>2</sup>	2 x 0.5 mm <sup>2</sup>
RX Photocells	4 x 0.5 mm <sup>2</sup>	4 x 0.5 mm <sup>2</sup>	4 x 0.5 mm <sup>2</sup>
Control devices	*no. x 0.5 mm <sup>2</sup>	*no. x 0.5 mm <sup>2</sup>	*no. x 0.5 mm <sup>2</sup>
Antenna		RG58 max 10 m	

\*no. = see product mounting instructions - Attention: the cable section is merely indicative as it depends on the motor power and cable length.

# COUNTERBALANCED, PARTIALLY RETRACTING, OVERHEAD GARAGE DOOR SINGLE MOTOR

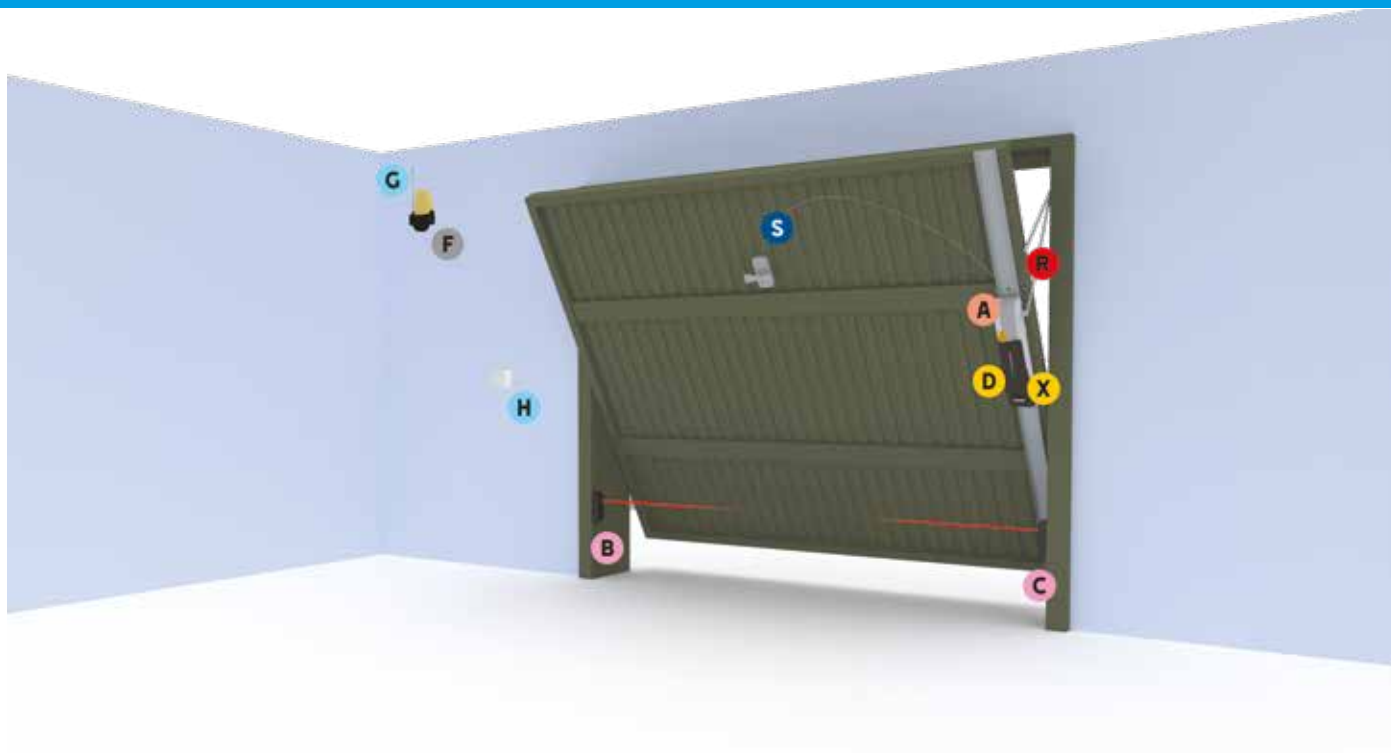

## COMPONENTS

- A** Operator (garmotor with control board)
- B** TX Photocells
- C** RX Photocells
- D** Control card for operating during power outages
- F** Flashing light
- G** Antenna
- H** Control switch  
(Key – Code – Card or transponder fob)
- R** Drive levers
- S** Pull-cord release device
- X** Radio frequency card

## CABLES FOR STANDARD INSTALLATIONS

LENGTH OF CABLE (m)	< 10	from 10 to 20	from 20 to 30
Power supply 230 V AC	3G x 1.5 mm <sup>2</sup>	3G x 1.5 mm <sup>2</sup>	3G x 2.5 mm <sup>2</sup>
Power supply to motor 24 V DC	2G x 1.5 mm <sup>2</sup>	2G x 1.5 mm <sup>2</sup>	2G x 2.5 mm <sup>2</sup>
Flashing light 24 V AC - DC	2 x 1 mm <sup>2</sup>	2 x 1 mm <sup>2</sup>	2 x 1 mm <sup>2</sup>
TX Photocells	2 x 0.5 mm <sup>2</sup>	2 x 0.5 mm <sup>2</sup>	2 x 0.5 mm <sup>2</sup>
RX Photocells	4 x 0.5 mm <sup>2</sup>	4 x 0.5 mm <sup>2</sup>	4 x 0.5 mm <sup>2</sup>
Control devices	*no. x 0.5 mm <sup>2</sup>	*no. x 0.5 mm <sup>2</sup>	*no. x 0.5 mm <sup>2</sup>
Antenna		RG58 max 10 m	

\*no. = see product mounting instructions - Attention: the cable section is merely indicative as it depends on the motor power and cable length.

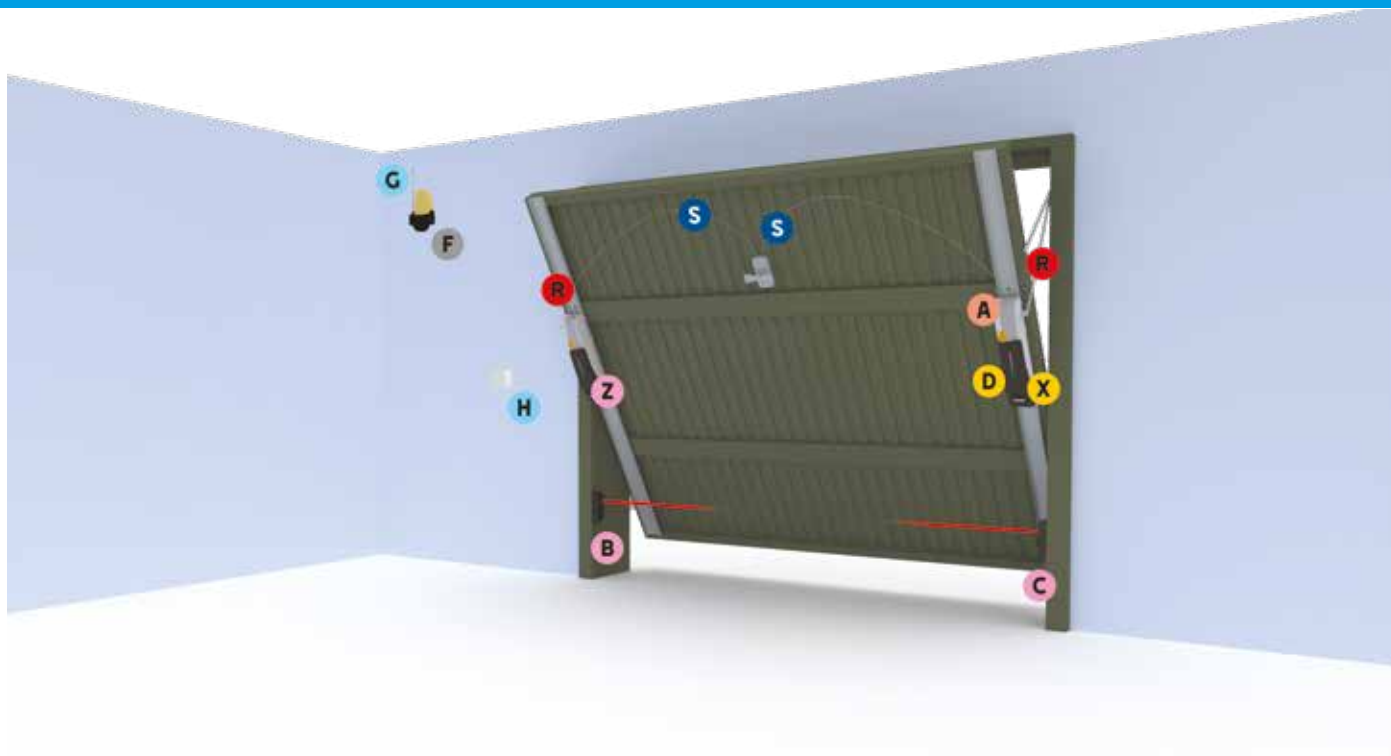

## COMPONENTS

- A** Operator (garmotor with control board)
- B** TX Photocells
- C** RX Photocells
- D** Control card for operating during power outages
- F** Flashing light
- G** Antenna
- H** Control switch  
(Key – Code – Card or transponder fob)
- R** Drive levers
- S** Pull-cord release device
- X** Radio frequency card

## CABLES FOR STANDARD INSTALLATIONS

LENGTH OF CABLE (m)	< 10	from 10 to 20	from 20 to 30
Power supply 230 V AC	3G x 1.5 mm <sup>2</sup>	3G x 1.5 mm <sup>2</sup>	3G x 2.5 mm <sup>2</sup>
Power supply to motor 24 V DC	2G x 1.5 mm <sup>2</sup>	2G x 1.5 mm <sup>2</sup>	2G x 2.5 mm <sup>2</sup>
Flashing light 24 V AC - DC	2 x 1 mm <sup>2</sup>	2 x 1 mm <sup>2</sup>	2 x 1 mm <sup>2</sup>
TX Photocells	2 x 0.5 mm <sup>2</sup>	2 x 0.5 mm <sup>2</sup>	2 x 0.5 mm <sup>2</sup>
RX Photocells	4 x 0.5 mm <sup>2</sup>	4 x 0.5 mm <sup>2</sup>	4 x 0.5 mm <sup>2</sup>
Control devices	*no. x 0.5 mm <sup>2</sup>	*no. x 0.5 mm <sup>2</sup>	*no. x 0.5 mm <sup>2</sup>
Antenna		RG58 max 10 m	

\*no. = see product mounting instructions - Attention: the cable section is merely indicative as it depends on the motor power and cable length.

# VER PLUS

OVERHEAD AND SECTIONAL DOORS



MAXIMUM DOOR SURFACE	PULL STRENGTH	USE	TYPE/APPLICATION
21 m <sup>2</sup>	1300 N	30 CYCLES/HOUR	PULLING

## Operator for sectional or up-and-over garage doors for use in private homes and industrial plants



- 24 V DC systems with encoder to guarantee greater safety and reliability.
- The operator is fastened directly onto the drive guide.
- Silent and reliable sliding guides, available with chain or belt.
- Control board with separate and removable terminal blocks.
- Save up to 250 different users.
- Display for programming and viewing features.
- Ready for operation in case of power outage.
- Integrated release lever, with the possibility of operating from the outside using the door handle.
- Developed with CONNECT technology for remote digital control via gateway or locally via GAME KEY.

### Dimensions (mm)

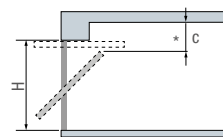
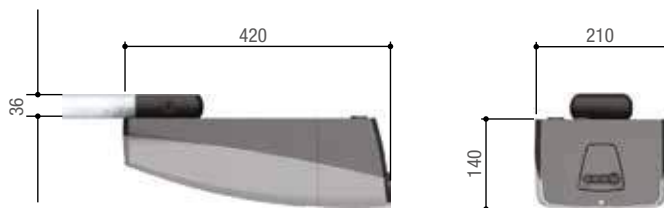

BC – Partially retracting, protruding overhead garage door.  
(con 001V201)

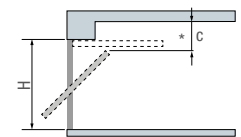

BM – Fully retracting, protruding overhead garage door.

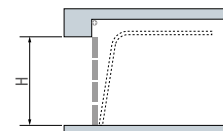

STA - SECTIONAL Type A with single guide

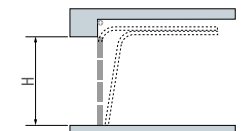

STB - SECTIONAL Type B with double-guide

C-distance = Min. 60 mm.  
H = Max. door height  
\* Maximum headroom of the door during movement  
(at about 2/3 of opening)

### Operational limits

MODELS	801MV-0010	801MV-0020
Max. surface of the door (m <sup>2</sup> )	18	21

### Technical characteristics

MODELS	801MV-0010	801MV-0020
Protection rating (IP)	40	40
Power supply (V - 50/60 Hz)	230 AC	230 AC
Power supply to motor (V)	24 DC	24 DC
Absorption (A)	10 Max.	10 Max.
Power (W)	180	280
Duty/cycle (%)	50	50
Cycles/Hour	30	30

## Code Description

### Complete operators with 24 V DC gearmotors, tested in compliance with regulatory standards EN 12453

**801MV-0010** VER10DMS - Operator with encoder, featuring a control panel for sectional and overhead garage doors.



**801MV-0020** VER13DMS - Operator with encoder, featuring a control panel for sectional and overhead garage doors.



### Accessories for: 801MV-0010 - 801MV-0020

**801XC-0010** Device for operation during power outages and for recharging the batteries (included are two 12 V - 0.8 Ah batteries).



### Accessories

**001V122** Drive arm for sectional doors with the distance between the upper edge of the door and the shaft-spring assembly between 300 and 600 mm.

**001V121** Pull-cord release and resetting device to fit on door handle. L = 3 m.

**001V201** Adapter arm for partially protruding overhead garage doors. Max. Door height: 2.4 m.

### Belt guides

**001V0685** Belt guide L = 3.02 m, for doors with max. surface of 15 m<sup>2</sup>.  
\*Max. door height:  
BC = 2.4 m BM = 2.25 m STA = 2.1 m STB = 2.2 m.

**001V0686** Belt guide L = 3.52 m, for doors with max. surface of 15 m<sup>2</sup>.  
\*Max. door height:  
BM = 2.75 m STA = 2.6 m STB = 2.7 m.

**001V0688** Belt guide L = 4.02 m, for doors with max. surface of 15 m<sup>2</sup>.  
\*Max. door height:  
BM = 3.25 m STA = 3.1 m STB = 3.2 m.

**001V0687** Belt guide L = 3.02 m in two pieces, for doors with max. surface of 15 m<sup>2</sup>.  
\*Max. door height:  
BC = 2.4 m BM = 2.25 m STA = 2.1 m STB = 2.2 m.

### Chain guide

**001V0679** Chain guide L = 3.02 m. \* Max. door height:  
BC = 2.4 m BM = 2.25 m STA = 2.1 m STB = 2.2 m.

**001V0682** Chain guide L = 3.02 m. \* Max. door height:  
BM = 2.75 m STA = 2.6 m STB = 2.7 m.

**001V0683** Chain guide L = 4.02 m. \* Max. door height:  
BM = 3.25 m STA = 3.1 m STB = 3.2 m.

**001V0684** Chain guide L = 3.02 m in two pieces. \* Max. door height:  
BC = 2.4 m BM = 2.25 m STA = 2.1 m STB = 2.2 m.

### Accessories for: chain guides

**001V005** Extension for chain-type guide:  
001V0679 - 001V0682 - 001V0683 - 001V0684 L = 1.42 m.



Note

\* BC = Counter-weighted overhead - BM = Spring-loaded overhead - STA = Sectional Type A - STB = Sectional Type B

MAXIMUM DOOR SURFACE	PULL STRENGTH	USE	TYPE/APPLICATION
12 m <sup>2</sup>	800 N	10 CYCLES/HOUR	PULLING

### Operator for sectional or up-and-over garage doors for use in private homes

- 24 V DC systems with encoder to guarantee greater safety and reliability.
- The operator is fastened directly onto the drive guide.
- Silent and reliable sliding guides, available with chain or belt.
- Control board with separate and removable terminal blocks.
- Save up to 250 different users.
- Display for programming and viewing features.
- Integrated release lever, with the possibility of operating from the outside using the door handle.



### Dimensions (mm)

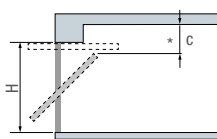
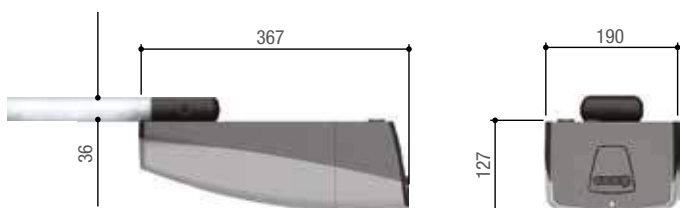

BC – Partially retracting, protruding overhead garage door. (con 001V201)

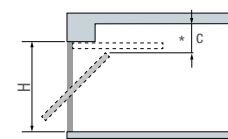

BM – Fully retracting, protruding overhead garage door.

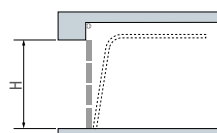

STA - Sectional Type A door with single guide

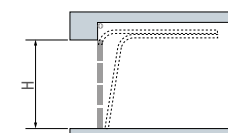

STB - Sectional Type B door with double guide.

C-distance = Min. 60 mm.  
 H = Max. door height  
 \* = Maximum overall dimensions, in height, of the door during movement (at about 2/3 of opening)

### Operational limits

MODELS	801MV-0050	801MV-0060
Max. surface of the door (m <sup>2</sup> )	9	12
Max. traction force (N)	600	800

### Technical characteristics

MODELS	801MV-0050	801MV-0060
Protection rating (IP)	20	20
Power supply (V - 50/60 Hz)	230 AC	230 AC
Power supply to motor (V)	24 DC	24 DC
Cycles/Hour	10	10
Operating temperature (°C)	-20 ÷ +55	-20 ÷ +55
Maneuvering speed (m/min)	6,6	8

Code	Description
<b>Complete operators with 24 V DC gearmotors, tested in compliance with regulatory standards EN 12453</b>	
<b>801MV-0050</b> 	VER06DES - Operator with encoder, featuring a control board with segmented graphic display, for sectional and overhead garage doors.
<b>801MV-0060</b> 	VER08DES - Operator with encoder, featuring a control board with segmented graphic display, for sectional and overhead garage doors.
<b>Accessories</b>	
001 <b>V122</b>	Drive arm for sectional doors with the distance between the upper edge of the door and the shaft-spring assembly between 300 and 600 mm.
001 <b>V121</b>	Pull-cord release and resetting device to fit on door handle. L = 3 m.
001 <b>V201</b>	Adapter arm for partially protruding overhead garage doors. Max. Door height: 2.4 m.
<b>Chain guide</b>	
001 <b>V06001</b>	Chain guide L = 3.02 m. *Max. door height: BC = 2.4 m - BM = 2.25 m - STA = 2.1 m.
001 <b>V06002</b>	Chain guide L = 3.52 m. * Max. door height: BM = 2.75 m - STA = 2.6 m STB = 2.7 m.
001 <b>V06003</b>	Chain guide L = 4.02 m. * Max. door height: BM = 3.25 m - STA = 3.1 m STB = 3.2 m.
<b>Belt guides</b>	
001 <b>V06005</b>	Belt guide L = 3.02 m. * Max. door height: BC = 2.4 m - BM = 2.25 m - STA = 2.1 m STB = 2.2 m.
001 <b>V06006</b>	Belt guide L = 3.52 m. * Max. door height: BM = 2.75 m - STA = 2.6 m STB = 2.7 m.
001 <b>V06007</b>	Belt guide L = 4.02 m. * Max. door height: BM = 3.25 m - STA = 3.1 m STB = 3.2 m.



Note

\* BC = Counter-weighted overhead - BM = Spring-loaded overhead - STA = Sectional Type A - STB = Sectional Type B

### ATTENTION

801MV-0050 - 801MV-0060 PRODUCTS AVAILABLE ONLY IN KITS. CONTACT THE SALES DEPARTMENT FOR INFORMATION.

MAXIMUM DOOR SURFACE	SPEED	USE	TYPE/APPLICATION
14 m <sup>2</sup>	ADJUSTABLE	INTENSIVE USE	ON THE DOOR



### Operator with direct fixing on the garage door

- Encoder-based movement control.
- Integrated release lever, with the possibility of operating from the outside using the door handle.
- Obstacle detection function, maneuver speed adjustment and opening and closing slow-down speed.
- Display for programming and viewing features, with LED for the operator diagnostics.

### Dimensions (mm)

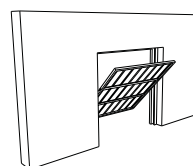
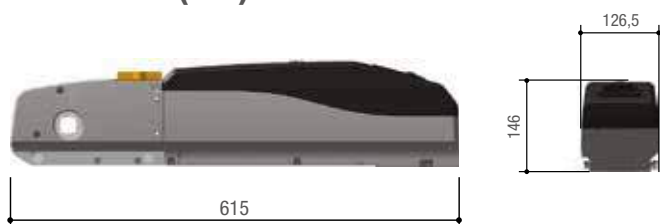

Protruding and partially retracting overhead garage door

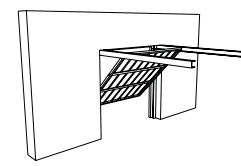

Protruding and fully retracting overhead garage door

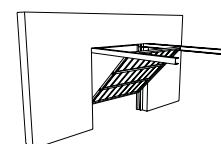

Non-protruding fully retracting overhead garage door

### Operational limits

MODELS	EM4024CB	EM4024
Max. surface of the door (m <sup>2</sup> )	9	14 (in combination with: 001EM4024CB)

NOTES: For doors larger than 9 m<sup>2</sup> and up to 14 m<sup>2</sup>, use: 1 EM4024CB gearmotor + 1 EM4024 gearmotor

### Technical characteristics

MODELS	EM4024CB	EM4024
Protection rating (IP)	40	40
Power supply (V - 50/60 Hz)	230 AC	-
Power supply to motor (V)	24 DC	24 DC
Absorption (A)	15 Max.	15 Max.
Power (W)	73	70
Maneuvering time at 90° (s)	ADJUSTABLE	ADJUSTABLE
Duty/cycle (%)	HEAVY-DUTY SERVICE	HEAVY-DUTY SERVICE
Operating temperature (°C)	-20 ÷ +55	-20 ÷ +55

## Code Description

### Complete operators with 24 V DC gearmotors, tested in compliance with regulatory standards EN 12453

**001EM4024CB** Irreversible operator with control board and segmented graphics display for doors measuring up to 9 m<sup>2</sup>.



### 24 V DC gearmotors, tested in compliance with regulatory standards EN 12453

**001EM4024** Irreversible gearmotor for pairing to the 001EM4024CB operator for extending the door's surface area up to 14 m<sup>2</sup>.



### Accessories for: 001EM4024CB

**002LBEM40** Control card for operating during power outages and for recharging the batteries, with fastening brace.



### Accessories for: 001EM4024

**001EM4001** LED control card for the courtesy light.



### Accessories

**001E001** Anchoring base L = 2 m.

**001E002** Fixing base L = 2.5 m.

**001V121** Pull-cord release and resetting device to fit on door handle. L = 3 m.

**001E781A** Accessories for fitting the lateral reset.

**001E782A** Transmission square tube 25 x 25 mm L = 2 m.

**001E783** Pair of folding drive arms.

**001E784** Long lever for hinged transmission arm for doors taller than 2.4 m.

**001E785A** Pair of straight telescopic arms with rectangular tube 40 x 10 mm.

**001E786A** Pair of curved telescopic arms with 40 x 10 mm rectangular tube.

**001E787A** Long tube for telescopic arms for doors with heights exceeding 2.4 m.



NOTES:  
002LBEM40 - Two 12 V - 1.3 Ah batteries (not supplied), on the 001EM4024CB - 001EM4024 there is a battery rack inside.



The tables shows lists all characteristics of the overhead and sectional door control-panels.  
The ones in bold type are important for choosing which operator to install and should be assessed from the start.

<b>Models / Series</b>	<b>VER PLUS</b>	<b>VER</b>	<b>EMEGA</b>
<b>Control board / Control panel</b>	ZL57	-	ZL43
<b>Safety</b>			
SELF-DIAGNOSING safety decives	●	●	●
PRE-FLASHING when opening and closing	●	●	●
REOPENING during closing	●	●	●
CLOSING AGAIN during opening	●		
Obstruction WAIT	●		●
TOTAL STOP	●	●	●
PARTIAL STOP	●		
OBSTRUCTION DETECTION in front of photocells	●	●	●
ENCODER	●	●	●
MOVEMENT CONTROLLING and OBSTRUCTION DETECTING device.		●	●
AMPEROMETRIC DETECTION	●	●	●
<b>Command</b>			
PARTIAL OPENING	●	●	●
OPEN ONLY from transmitter and/or from button	●	●	●
ONLY OPEN or ONLY CLOSE button connection	●	●	●
OPEN-STOP-CLOSE-STOP from the transmitter and/or button	●	●	●
OPEN-CLOSE-INVERT from the transmitter and/or button	●	●	●
MAINTAINED ACTION	●		●
IMMEDIATE CLOSING			●
<b>Characteristics</b>			
FLASHING LIGHT connection	●	●	●
CYCLE LIGHT connection	●	●	●
COURTESY LIGHT connection	●	●	●
Antenna	●	●	●
OPEN ALERT LIGHT connection			●
SELF-LEARNING of the transmitter's RADIO CODE	●	●	●
OPERATING TIME adjusting	●		●
Adjustable AUTOMATIC CLOSING AGAIN TIME	●	●	●
OPENING and/or CLOSING slow downs	●	●	●
EMERGENCY BATTERY operation (optional)	●		●
Adjustable TRAVEL and SLOW-DOWN speeds*	●		●
DISPLAY	●	●	●
SELF-LEARNING opening and closng limit-switches	●		●
CAME Connect	●		
Designed to fit RIO System 2.0	●		
CRP control	●		
ENERGY SAVINGS control (001RGP1)	●		

● 24 V DC

Note

\* The partial opening can be activated via button, selector and transmitter.

# AUTOMATIC BARRIERS

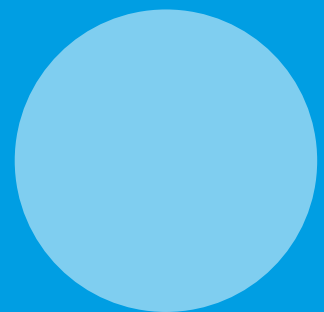
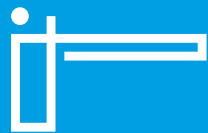

132	SELECTION GUIDE
140	GARD LT4
144	GAD LS4
150	GARD GT4
156	GARD PX
160	GARD 5000
162	GARD
168	GARD GT8
174	GARD 12
176	UNIPARK
178	CAT
180	CONTROL BOARD FUNCTIONS

# Selection guide

## Automatic barriers

The table summarizes the series and models with their corresponding operating limits according to maximum net clearance width.

Series	Model	Max. net clearance width (m)
GARD PX	803BB-0120	3,8
GARD LS4	803BB-0410	3,8
GARD LS4	803BB-0430	3,8
GARD LS4	803BB-0440	3,8
GARD LT4	803BB-0370	4
GARD LT4	803BB-0390	4
GARD LT4	803BB-0400	4
GARD GT4	803BB-0280	5
GARD GT4	803BB-0240	5
GARD GT4	803BB-0260	5
GARD 5000	G5000	5
GARD	G6000	6,5
GARD	G6001	6,5
GARD	G6500	6,5
GARD	G6501	6,5
GARD GT8	803BB-0180	7.8
GARD GT8	803BB-0290	7.8
GARD GT8	803BB-0250	7.8
GARD GT8	803BB-0270	7.8
GARD 12	G12000K	12

● 24 - 36 V DC

## Parking guard and chain barrier

The tables summarize the series and models with their respective operating limits according to the maximum width of the parking place or the maximum clearance width.

Series	Model	Max clearance width of parking space (m)
UNIPARK	UNIP + ARK1	2
UNIPARK	UNIP + ARK2	2,45

Series	Model	Max. net clearance width (m)
CAT	CAT-5	8
CAT	CAT-15	16

● 230 V AC ● 24 V DC



**BARRIERS FOR SMALL RESIDENTIAL CONTEXTS**  
CAME barriers can be used for apartment buildings and small parking lots.



**HEAVY-DUTY SINGLE OR DOUBLE BARRIERS**  
You can manage heavily trafficked parking facilities such as at company parking lots, auto dealerships or even private parking areas.



**PARKING-FACILITY BARRIERS**  
The simple, practical solution for controlling transit flows in pay-to-park areas.



**BARRIERS FOR VERY WIDE CLEARANCES**  
CAME barriers are used even for passages where special or oversized vehicles transit.



**FOR SINGLE PARKING SPACES**  
Ideal for apartment-building parking facilities or for authorized staff parking.



**FOR MULTIPLE PARKING SPACES**  
Ideal for small apartment-blocks or when a low-profile barrier is required.

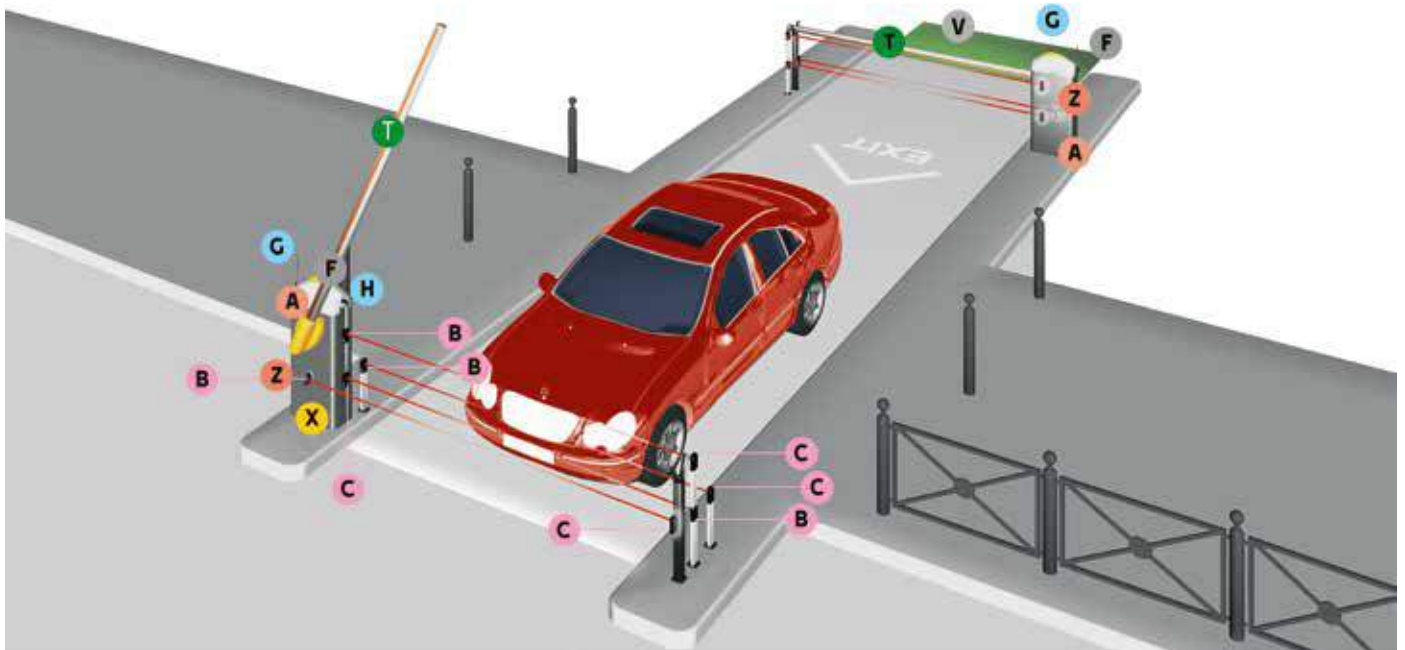

## COMPONENTS

- A** Barrier
- B** TX Photocells
- C** RX Photocells
- F** Flashing light
- G** Antenna
- H** Control switch  
(Key – Code – Card or transponder fob)
- T** Boom with luminous cord
- X** Radio frequency card
- V** Metal mass detector sensor
- Z** Release device

## CABLES FOR STANDARD INSTALLATIONS

LENGTH OF CABLE (m)	< 10	from 10 to 20	from 20 to 30
Power supply 230 V AC	3G x 1.5 mm <sup>2</sup>	3G x 1.5 mm <sup>2</sup>	3G x 2.5 mm <sup>2</sup>
Flashing light 24 V AC - DC	2 x 1 mm <sup>2</sup>	2 x 1 mm <sup>2</sup>	2 x 1 mm <sup>2</sup>
TX Photocells	2 x 0.5 mm <sup>2</sup>	2 x 0.5 mm <sup>2</sup>	2 x 0.5 mm <sup>2</sup>
RX Photocells	4 x 0.5 mm <sup>2</sup>	4 x 0.5 mm <sup>2</sup>	4 x 0.5 mm <sup>2</sup>
Control devices	*no. x 0.5 mm <sup>2</sup>	*no. x 0.5 mm <sup>2</sup>	*no. x 0.5 mm <sup>2</sup>
Antenna		RG58 max 10 m	

\*no. = see product mounting instructions - Attention: the cable section is merely indicative as it depends on the motor power and cable length.

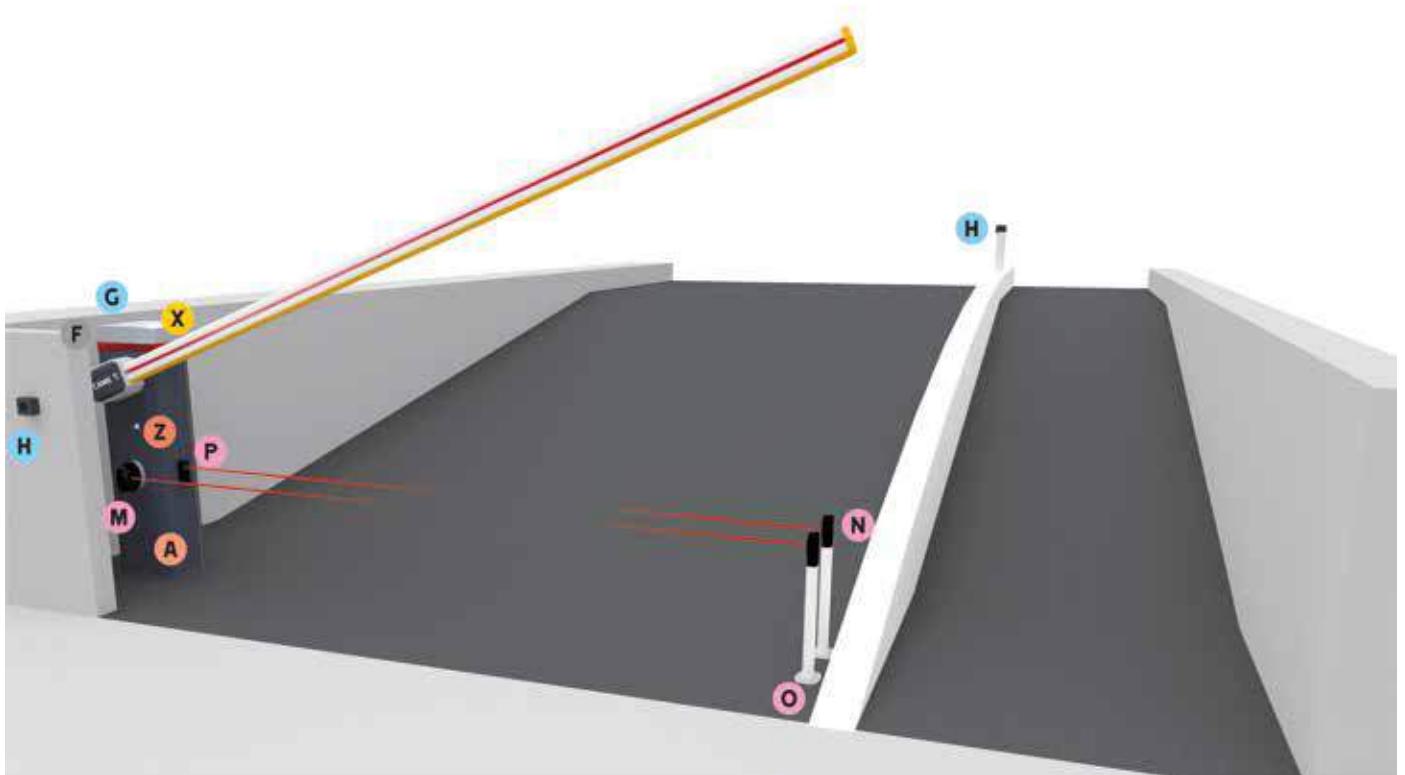

**COMPONENTS**

- A** Barrier
- F** Flashing light
- G** Antenna
- H** Control switch
- (Key – Code – Card or transponder fob)
- M** TX Photocells
- N** TX Photocells
- O** RX Photocells
- P** RX Photocells
- X** Radio frequency card
- Z** Release device

**CABLES FOR STANDARD INSTALLATIONS**

LENGTH OF CABLE (m)	< 10	from 10 to 20	from 20 to 30
Power supply 230 V AC	3G x 1.5 mm <sup>2</sup>	3G x 1.5 mm <sup>2</sup>	3G x 2.5 mm <sup>2</sup>
Power supply to motor 24 or 36 V DC	2G x 1.5 mm <sup>2</sup>	2G x 1.5 mm <sup>2</sup>	2G x 2.5 mm <sup>2</sup>
Limit switch micro-switches	*no. x 0.5 mm <sup>2</sup>	*no. x 0.5 mm <sup>2</sup>	*no. x 0.5 mm <sup>2</sup>
Flashing light 24 V AC - DC	2 x 1 mm <sup>2</sup>	2 x 1 mm <sup>2</sup>	2 x 1 mm <sup>2</sup>
TX Photocells	2 x 0.5 mm <sup>2</sup>	2 x 0.5 mm <sup>2</sup>	2 x 0.5 mm <sup>2</sup>
RX Photocells	4 x 0.5 mm <sup>2</sup>	4 x 0.5 mm <sup>2</sup>	4 x 0.5 mm <sup>2</sup>
Control devices	*no. x 0.5 mm <sup>2</sup>	*no. x 0.5 mm <sup>2</sup>	*no. x 0.5 mm <sup>2</sup>
Antenna		RG58 max 10 m	

\*no. = see product mounting instructions - Attention: the cable section is merely indicative as it depends on the motor power and cable length.

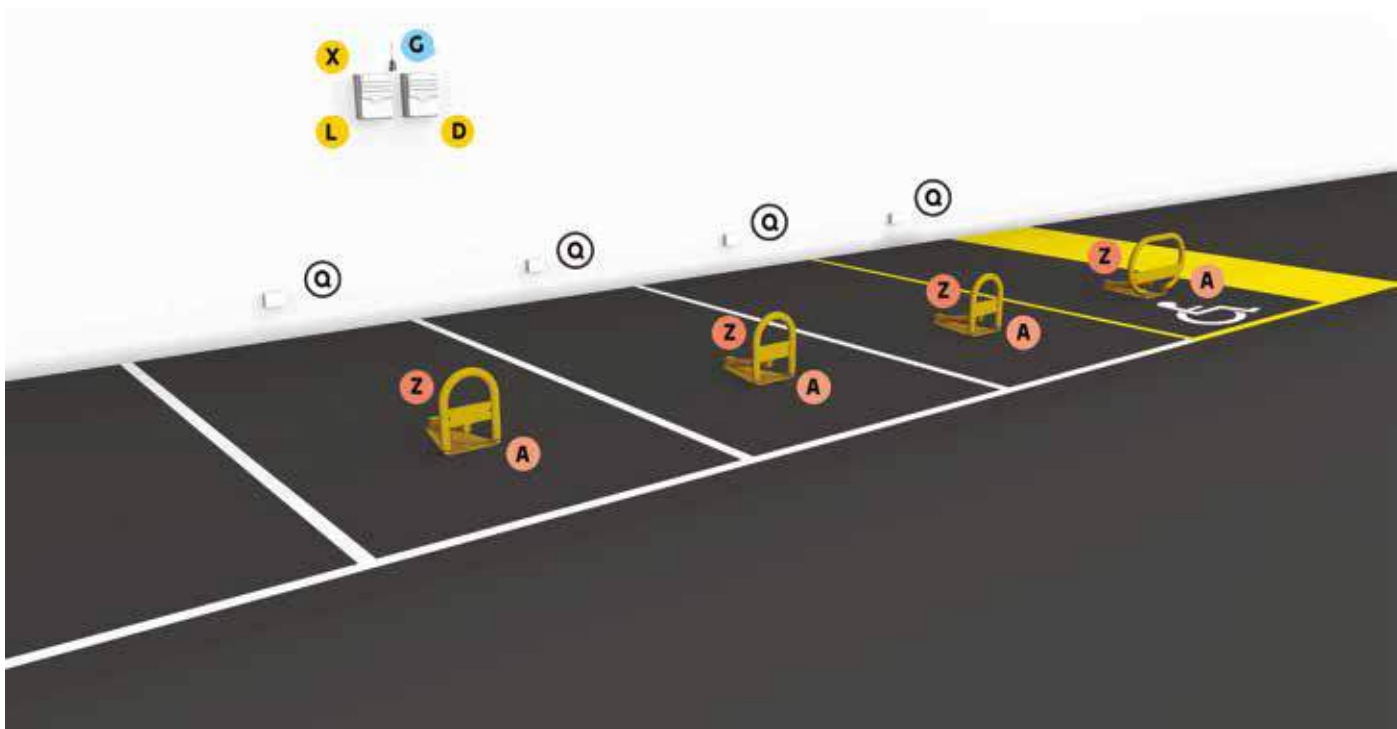

## COMPONENTS

- A Gearmotors
- D Control card for operating during power outages
- G Antenna
- L Control panel
- Q Junction box
- X Radio frequency card
- Z Release device

## CABLES FOR STANDARD INSTALLATIONS

LENGTH OF CABLE (m)	< 10	from 10 to 20	from 20 to 30
Power supply 230 V AC	3G x 1.5 mm <sup>2</sup>	3G x 1.5 mm <sup>2</sup>	3G x 2.5 mm <sup>2</sup>
Power supply to motor 24 V DC	2G x 1.5 mm <sup>2</sup>	2G x 1.5 mm <sup>2</sup>	2G x 2.5 mm <sup>2</sup>
Flashing light 24 V AC - DC	2 x 1 mm <sup>2</sup>	2 x 1 mm <sup>2</sup>	2 x 1 mm <sup>2</sup>
Control devices	*no. x 0.5 mm <sup>2</sup>	*no. x 0.5 mm <sup>2</sup>	*no. x 0.5 mm <sup>2</sup>
Antenna		RG58 max 10 m	

\*no. = see product mounting instructions - Attention: the cable section is merely indicative as it depends on the motor power and cable length.

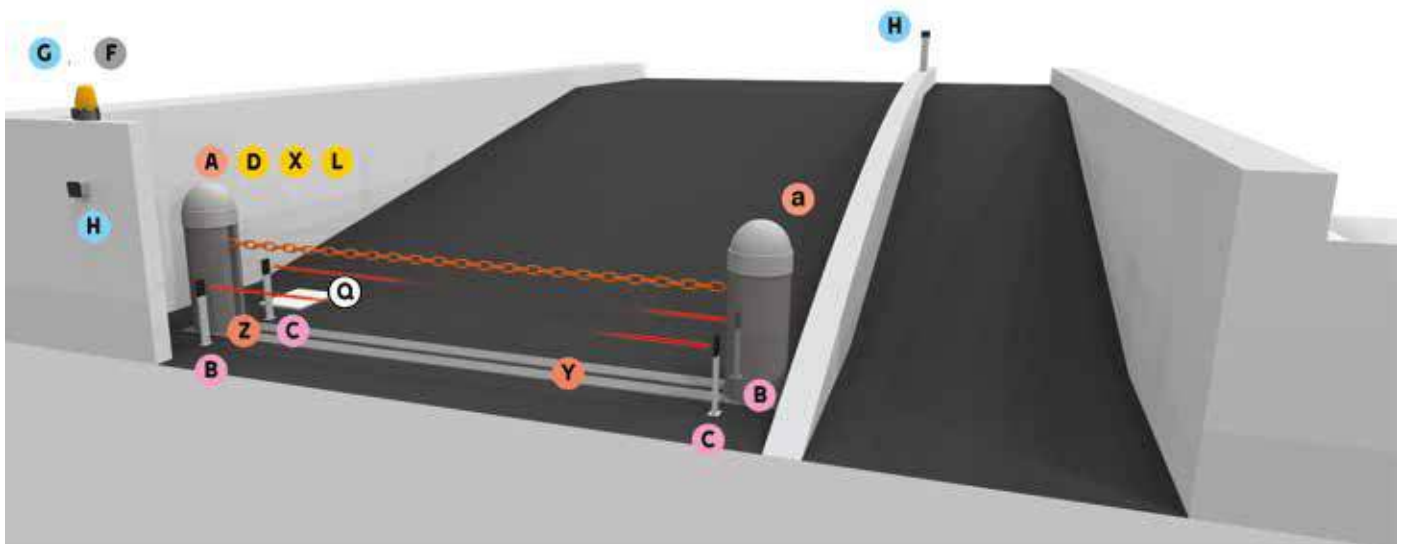

## COMPONENTS

- A** Post with gearmotor
- a** Post with counter-weight and chain latch
- B** TX Photocells
- C** RX Photocells
- D** Control card for operating during power outages
- F** Flashing light
- G** Antenna
- H** Control switch  
(Key – Code – Card or transponder fob)
- L** Control panel
- Q** Junction box
- X** Radio frequency card
- Y** Outer chain-protecting guide
- Z** Release device

## CABLES FOR STANDARD INSTALLATIONS

LENGTH OF CABLE (m)	< 10	from 10 to 20	from 20 to 30
Power supply 230 V AC	3G x 1.5 mm <sup>2</sup>	3G x 1.5 mm <sup>2</sup>	3G x 2.5 mm <sup>2</sup>
Power supply to motor 230 V AC	3G x 1.5 mm <sup>2</sup>	3G x 1.5 mm <sup>2</sup>	3G x 2.5 mm <sup>2</sup>
Power supply to motor 24 V DC	2G x 1.5 mm <sup>2</sup>	2G x 1.5 mm <sup>2</sup>	2G x 2.5 mm <sup>2</sup>
Flashing light 24 V AC - DC	2 x 1 mm <sup>2</sup>	2 x 1 mm <sup>2</sup>	2 x 1 mm <sup>2</sup>
Flashing light 230 V AC	2 x 1.5 mm <sup>2</sup>	2 x 1.5 mm <sup>2</sup>	2 x 1.5 mm <sup>2</sup>
TX Photocells	2 x 0.5 mm <sup>2</sup>	2 x 0.5 mm <sup>2</sup>	2 x 0.5 mm <sup>2</sup>
RX Photocells	4 x 0.5 mm <sup>2</sup>	4 x 0.5 mm <sup>2</sup>	4 x 0.5 mm <sup>2</sup>
Control devices	*no. x 0.5 mm <sup>2</sup>	*no. x 0.5 mm <sup>2</sup>	*no. x 0.5 mm <sup>2</sup>
Antenna		RG58 max 10 m	

\*no. = see product mounting instructions - Attention: the cable section is merely indicative as it depends on the motor power and cable length.

# CHAIN BARRIER WITH TWO-LEVEL PHOTOCELLS

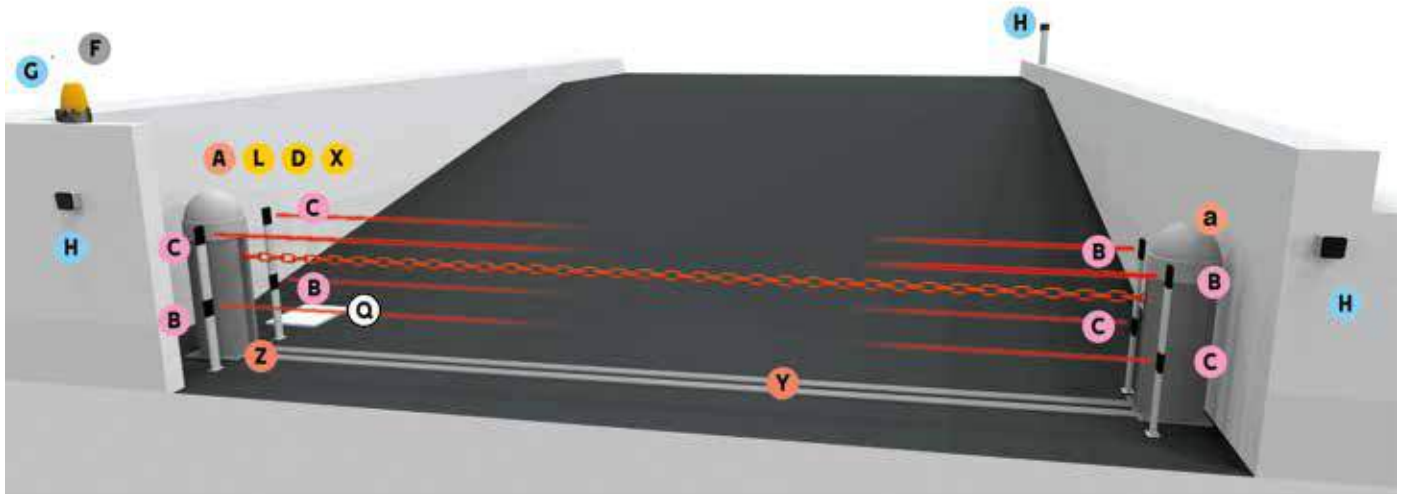

## COMPONENTS

- A** Post with gearmotor
- a** Post with counter-weight and chain latch
- B** TX Photocells
- C** RX Photocells
- D** Control card for operating during power outages
- F** Flashing light
- G** Antenna
- H** Control switch  
(Key – Code – Card or transponder fob)
- L** Control panel
- Q** Junction box
- X** Radio frequency card
- Y** Outer chain-protecting guide
- Z** Release device

## CABLES FOR STANDARD INSTALLATIONS

LENGTH OF CABLE (m)	< 10	from 10 to 20	from 20 to 30
Power supply 230 V AC	3G x 1.5 mm <sup>2</sup>	3G x 1.5 mm <sup>2</sup>	3G x 2.5 mm <sup>2</sup>
Power supply to motor 230 V AC	3G x 1.5 mm <sup>2</sup>	3G x 1.5 mm <sup>2</sup>	3G x 2.5 mm <sup>2</sup>
Power supply to motor 24 V DC	2G x 1.5 mm <sup>2</sup>	2G x 1.5 mm <sup>2</sup>	2G x 2.5 mm <sup>2</sup>
Flashing light 24 V AC - DC	2 x 1 mm <sup>2</sup>	2 x 1 mm <sup>2</sup>	2 x 1 mm <sup>2</sup>
Flashing light 230 V AC	2 x 1.5 mm <sup>2</sup>	2 x 1.5 mm <sup>2</sup>	2 x 1.5 mm <sup>2</sup>
TX Photocells	2 x 0.5 mm <sup>2</sup>	2 x 0.5 mm <sup>2</sup>	2 x 0.5 mm <sup>2</sup>
RX Photocells	4 x 0.5 mm <sup>2</sup>	4 x 0.5 mm <sup>2</sup>	4 x 0.5 mm <sup>2</sup>
Control devices	*no. x 0.5 mm <sup>2</sup>	*no. x 0.5 mm <sup>2</sup>	*no. x 0.5 mm <sup>2</sup>
Antenna		RG58 max 10 m	

\*no. = see product mounting instructions - Attention: the cable section is merely indicative as it depends on the motor power and cable length.



# DXR

ADJUSTABLE  
INFRARED  
PHOTOCELLS ALSO  
AVAILABLE FOR CXN  
BUS SYSTEMS

FIND OUT MORE ON PAGE 218

**CAME** 

[CAME.COM](http://CAME.COM)



# GARD LT4

Automatic barriers



PASSAGE WIDTH CLEARANCE	MCBF	USE	SPEED
UP TO 4 m	1,5 MILLION CYCLES	300 CYCLES/HOUR	FROM 2 TO 6 SEC



## Ideal solution for heavy-duty service on driveway

- 24 V DC operator with Advanced Speed Control.
- Tested for intensive use of 300 cycles/hour with MCBF 1,5 million cycles.
- Cabinet available in galvanized steel and painted RAL2004, AISI 304 steel, or in customized color.
- Control board with display designed to connect to the Cloud via CAME Connect.
- Accessories that can be integrated directly into the cabinet.
- High visibility white signaling LED on the boom.
- It can be integrated with third party systems through MODBUS protocol.

## Dimensions (mm)

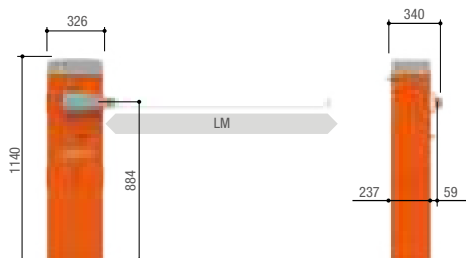

LM = Max. net clearance width

## Operational limits

MODELS	803BB-0370	803BB-0390	803BB-0400
Max. net clearance width (m)	4	4	4

## Technical characteristics

MODELS	803BB-0370	803BB-0390	803BB-0400
Protection rating (IP)	54	54	54
Power supply (V - 50/60 Hz)	220-230 AC	220-230 AC	220-230 AC
Power supply to motor (V)	24 DC	24 DC	24 DC
Power (W)	190	190	190
Opening time at 90° (s)	2 ÷ 6	2 ÷ 6	2 ÷ 6
Cycles/Hour	300	300	300
Operating temperature (°C)	-20 ÷ +55 (-40 with item 803XA-0630)	-20 ÷ +55 (-40 with item 803XA-0630)	-20 ÷ +55 (-40 with item 803XA-0630)
RAL color	2004	RAL X	-

● 24 V DC

## Code Description

### 230 V AC barriers with encoder and 24 V DC operator and built-in control panel

**803BB-0370**



GLT40AOS - Automatic barrier with irreversible gearmotor 24 V DC with encoder; painted galvanised steel cabinet; accessories available. Balance spring included.

**803BB-0390**



GLT40ACS - Automatic barrier with irreversible gearmotor 24 V DC with encoder; custom-RAL painted galvanised steel cabinet; accessories available. Balance spring included.

**803BB-0400**



GLT40AX4 - Automatic barrier with irreversible gearmotor 24 V DC with encoder; satin-finish AISI 304 steel cabinet; accessories available. Balance spring included.

### Accessories for barriers

001**G0401**

White painted aluminum boom with end cap.  
Section 60 x 40 mm, boom length: 4.2 m.

001**G0402**

Tube section barrier made of white, painted aluminum.  
Ø 60 mm, boom length: 4.2 m.

002**RSE**

Interface card for controlling two operators or for enabling the Came Remote Protocol.

001**R700**

Control board for decoding and access-control management via transponder selector.

001**R800**

Control board for decoding and access-control management via keypad selectors.

**803XA-0300**

Auxiliary contacts unit for detecting the boom position

001**G02802**

Support for fitting DIR-series photocells.

**803XC-0020**

Modbus TCP/RTU bridge for integration with third party systems.

**803XA-0630**



Cartridge heater with thermostat.



#### NOTES:

001G02802 It cannot be used with a boom equipped with a skirt or swing rest

# THE COMPLETE RANGE

## Code Description

Accessories for: 001G0401

001**G0403** Red rubber shock-proof edge with end caps.



**803XA-0580** White LED strip for 60X40 boom, length 4 m.



Accessories for: 001G0402

**803XA-0590** Attachment for tubular boom 60 mm.



Accessories for: 001G0401 - 001G0402

**803XA-0330** Swing rest.



001**G02807** Fixed rest.



**803XA-0340** Painted aluminum skirt. 1720 mm module complete with junction brackets.



**803XA-0440** Swing rest - skirt support bracket.



001**G0461** Package of 24 red, reflective, adhesive strips.



### 24 V DC accessories for barriers

**803XA-0290** Control card kit for operating during power outages and for recharging batteries, with battery housing.



**806XG-0030** Opening and safety detector with laser technology.



009**SMA** Single.-channel magnetic sensor for detecting metal masses.



009**SMA2** Two-channel magnetic sensor for detecting metal masses.



Accessories for: 806XG-0030

**818XG-0019** Remote control for opening and safety detector.



**806XG-0050** Steel support for opening detector and barrier safety.



**806XG-0040** 24 V DC power supply for opening and safety detector.



## ATTENTION

803XA-0340 - Standard skirt:  
- Max. 2 modules for 4-meter boom.

When the passage width clearance is greater than 3 m, it is compulsory to use a boom rest to support it (fixed or movable).



## FITTED FOR BALANCING SPRING

Point A, B and C are the springs' fastening points, depending on the clearance width.

The spring attachment points A, B and C refer to the table above.

### GUIDE TO POSITIONING THE BALANCING SPRING

Boom composition	LATERAL CLEARANCE WIDTH (m)					
	2,00 < 2,25	2,25 < 2,75	2,75 < 3,25	3,25 < 3,50	3,50 < 3,75	3,75 < 4,00
Boom	-	A	A	A	B	B
Boom with shock-absorbing profile and LED strip	A	A	B	B	C	C
Boom with single rack	A	B	C	C	-	-
Boom with mobile stand	B	B	B	C	C	-
Boom with anti-collision profile and swing rest	B	B	C	-	-	-



## SINGLE SPRING BALANCING

CAME's R&D department has developed a practical variable balancing system, which allows using a single spring that can be connected to the balancing lever at different predefined points. It is therefore no longer necessary to have specific springs for the different boom lengths, but it is sufficient to operate on the hooking system.



## SIMPLE CONFIGURATION

The control board is positioned directly under the cabinet cover. All the configuration and maintenance phases can therefore be carried out comfortably standing upright, with the cabinet closed, in complete safety.



## FOLDING SKIRT

Suitable for both residential and industrial use, the folding skirt is the ideal solution to prevent access by pedestrians or unauthorized vehicles.

# GARD LS4

Automatic barriers



PASSAGE WIDTH CLEARANCE	MCBF	USE	SPEED
UP TO 3.8 m	1,5 MILLION CYCLES	300 CYCLES/HOUR	FROM 2 TO 6 SEC



## Ideal solution for heavy-duty service on driveway

- 24 V DC operator with Advanced Speed Control.
- Tested for intensive use of 300 cycles/hour with MCBF 1,5 million cycles.
- Cabinet available in galvanized steel and painted RAL7024, AISI 304 steel, or in customized color.
- Control board with display designed to connect to the Cloud via CAME Connect.
- Accessories that can be integrated directly into the cabinet.
- Set up for high visibility red/green LEDs on both sides of the boom.
- It can be integrated with third party systems through MODBUS protocol.

## Dimensions (mm)

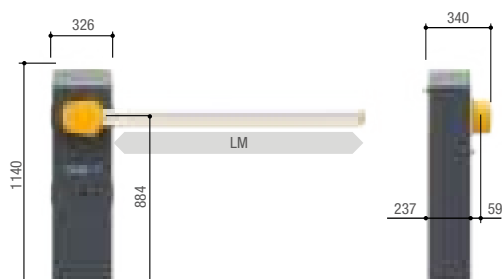

LM = Max. net clearance width

## Operational limits

MODELS	803BB-0410	803BB-0430	803BB-0440
Max. net clearance width (m)	3,8	3,8	3,8

## Technical characteristics

MODELS	803BB-0410	803BB-0430	803BB-0440
Protection rating (IP)	54	54	54
Power supply (V - 50/60 Hz)	220-230 AC	220-230 AC	220-230 AC
Power supply to motor (V)	24 DC	24 DC	24 DC
Power (W)	190	190	190
Opening time at 90° (s)	2 ÷ 6	2 ÷ 6	2 ÷ 6
Cycles/Hour	300	300	300
Operating temperature (°C)	-20 ÷ +55 (-40 with item 803XA-0630)	-20 ÷ +55 (-40 with item 803XA-0630)	-20 ÷ +55 (-40 with item 803XA-0630)
RAL color	7024	RAL X	-

● 24 V DC

Code	Description
------	-------------

230 V AC barriers with encoder and 24 V DC operator and built-in control panel	
<b>803BB-0410</b> 	GLS40AGS - Automatic barrier with irreversible gearmotor 24 V DC with encoder; painted galvanised steel cabinet; accessories available. Balance spring included.
<b>803BB-0430</b> 	GLS40ACS - Automatic barrier with irreversible gearmotor 24 V DC with encoder; custom-RAL painted galvanised steel cabinet; accessories available. Balance spring included.
<b>803BB-0440</b> 	GLS40AX4 - Automatic barrier with irreversible gearmotor 24 V DC with encoder; satin-finish AISI 304 steel cabinet; accessories available. Balance spring included.

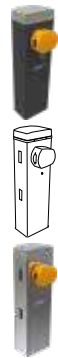

# THE COMPLETE RANGE

## Code Description

Code	Description
Accessories for barriers	
<b>803XA-0050</b>	White painted aluminum boom, 90 x 35 mm, with groove cover-strip and shock-proof rubber profile. Length: 4050 mm.
<b>803XA-0051</b>	White painted aluminum boom, 90 x 35 mm, with groove cover strip and shock-proof rubber profile. Length: 3050 mm.
001 <b>G0402</b>	Tube section barrier made of white, painted aluminum. Ø 60 mm, boom length: 4.2 m.
002 <b>RSE</b>	Interface card for controlling two operators or for enabling the Came Remote Protocol.
001 <b>R700</b>	Control board for decoding and access-control management via transponder selector.
001 <b>R800</b>	Control board for decoding and access-control management via keypad selectors.
<b>803XA-0300</b>	Auxiliary contacts unit for detecting the boom position
001 <b>G02802</b>	Support for fitting DIR-series photocells.
<b>803XC-0020</b>	Modbus TCP/RTU bridge for integration with third party systems.
<b>803XA-0630</b>	Cartridge heater with thermostat.



NOTES:  
001G02802 It cannot be used with a boom equipped with a skirt or swing rest

Code	Description
Accessories for: 803XA-0050 - 803XA-0051	
<b>803XA-0560</b>	HD (Heavy Duty) joint for 90 x 35 mm boom.
<b>803XA-0570</b>	Detachable boom attachment 90 x 35 mm. After impact, the pivot coupling releases the rod and the end rests on the ground.
<b>803XA-0020</b>	Red/green LED strips for booms up to 4-m long.
<b>803XA-0150</b>	Red/green LED strip for booms up to 3 m long.
<b>803XA-0160</b>	Red/green LED strip for jointed HD (Heavy Duty) boom up to 2 m long.
<b>803XA-0190</b>	LED strips connection kit for HD jointed booms (Heavy Duty).
001 <b>G02807</b>	Fixed rest.
<b>803XA-0330</b>	Swing rest.
<b>803XA-0440</b>	Swing rest - skirt support bracket.
<b>803XA-0340</b>	Painted aluminum skirt. 1720 mm module complete with junction brackets.
001 <b>G02809</b>	Package of 20 red, reflective, adhesive strips.



## ATTENTION

**803XA-0340 - Standard skirt:**  
- Max. 2 modules for 4-meter boom.

NOTES:  
When the passage width clearance is greater than 3 m, it is compulsory to use a boom rest to support it (fixed or movable).  
803XA-0560 and 803XA-0570 cannot be installed together.

# THE COMPLETE RANGE

## Code Description

Accessories for: 001G0402

**803XA-0590** Attachment for tubular boom 60 mm.



001**G0461** Package of 24 red, reflective, adhesive strips.



### 24 V DC accessories for barriers

**803XA-0290** Control card kit for operating during power outages and for recharging batteries, with battery housing.



**806XG-0030** Opening and safety detector with laser technology.



009**SMA** Single.-channel magnetic sensor for detecting metal masses.



009**SMA2** Two-channel magnetic sensor for detecting metal masses.



Accessories for: 806XG-0030

**818XG-0019** Remote control for opening and safety detector.



**806XG-0050** Steel support for opening detector and barrier safety.



**806XG-0040** 24 V DC power supply for opening and safety detector.





## FITTED FOR BALANCING SPRING

Point A, B and C are the springs' fastening points, depending on the clearance width.

The spring attachment points A, B and C refer to the table above.

Boom composition	LATERAL CLEARANCE WIDTH (m)				
	2,00 < 2,25	2,25 < 2,75	2,75 < 3,25	3,25 < 3,50	3,50 < 3,8
Boom with LED strip	A	A	B	B	C
Boom with LED strip and single skirt	B	B	C	-	-
Boom with LED strip and swing rest	B	B	C	C	-
Boom with single rack	B	B	C	-	-
Boom with mobile stand	B	B	C	C	C



## SINGLE SPRING BALANCING

CAME's R&D department has developed a practical variable balancing system, which allows using a single spring that can be connected to the balancing lever at different predefined points. It is therefore no longer necessary to have specific springs for the different boom lengths, but it is sufficient to operate on the hooking system.



## SIMPLE CONFIGURATION

The control board is positioned directly under the cabinet cover. All the configuration and maintenance phases can therefore be carried out comfortably standing upright, with the cabinet closed, in complete safety.

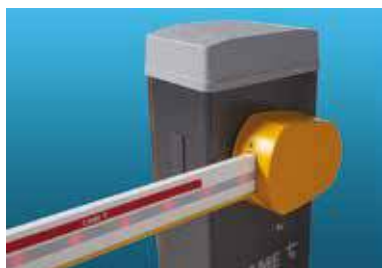

## RG LED

The LED strip system can be installed on both sides of the boom and regulates access through the traffic light function.

# GARD GT4

Automatic barriers



PASSAGE WIDTH CLEARANCE	MCBF	USE	SPEED
UP TO 5 m	3 MILLION CYCLES	350 CYCLES/HOUR	FROM 2 TO 6 SEC



## Ideal solution for heavy-duty service on driveway

- 24 V DC operator with Advanced Speed Control.
- Tested for intensive use of 350 cycles/hour with MCBF 3 million cycles.
- Cabinet available in galvanized steel and painted RAL7024, AISI 304 and AISI 316 steel, or in customized color.
- Control board with display, CONNECT technology and inputs for CXN BUS accessories.
- Accessories that can be integrated directly into the cabinet.
- High visibility red/green LEDs on the crown and on both sides of the boom.
- It can be integrated with third party systems through MODBUS protocol.

## Dimensions (mm)

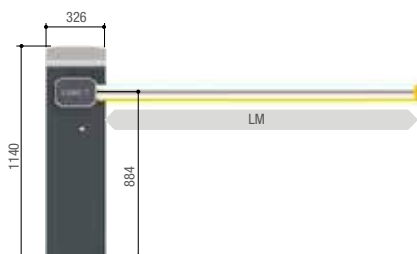

LM = Max. net clearance width

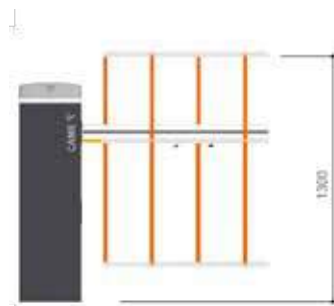

803XA-0350

## Operational limits

MODELS	803BB-0160	803BB-0280	803BB-0240	803BB-0260
Max. net clearance width (m)	5	5	5	5

## Technical characteristics

MODELS	803BB-0160	803BB-0280	803BB-0240	803BB-0260
Protection rating (IP)	54	54	54	54
Power supply (V - 50/60 Hz)	230 AC	230 AC	230 AC	230 AC
Power supply to motor (V)	24 DC	24 DC	24 DC	24 DC
Power (W)	240	240	240	240
Opening time at 90° (s)	2 ÷ 6	2 ÷ 6	2 ÷ 6	2 ÷ 6
Cycles/Hour	350	350	350	350
Operating temperature (°C)	-20 ÷ +55 (-40 with item 001PSRT01)	-20 ÷ +55 (-40 with item 001PSRT01)	-20 ÷ +55 (-40 with item 001PSRT01)	-20 ÷ +55 (-40 with item 001PSRT01)
RAL color	7024	RAL X	-	-

● 24 V DC

Code	Description
------	-------------

230 V AC barriers with encoder and 24 V DC operator and built-in control panel	
<b>803BB-0160</b> 	GGT40AGS - Automatic barrier with irreversible 24 V DC operator with encoder; galvanized steel and painted cabinet with set up for fitting accessories. Balancing spring included.
<b>803BB-0280</b> 	GGT40ACS - Automatic barrier with irreversible 24 V DC operator with encoder; galvanized steel cabinet with customized RAL painting and set up for fitting accessories. Balancing spring included.
<b>803BB-0240</b> 	GGT40AX4 - Automatic barrier with irreversible 24 V DC operator with encoder; AISI 304 satin-finish steel cabinet with set up for fitting accessories. Balancing spring included.
<b>803BB-0260</b> 	GGT40AX6 - Automatic barrier with 24 V DC irreversible operator with encoder; AISI 316 satin-finish steel cabinet with set up for fitting accessories. Balancing spring included.



# THE COMPLETE RANGE

## Code Description

Code	Description
Accessories for barriers	
<b>803XA-0270</b>	White painted aluminum boom, 90 x 60 mm, with internal reinforcement, groove cover-strip and shock-proof rubber profile. Length: 4220 mm.
<b>803XA-0640</b>	Modular aluminium rod, painted white, comprising: no. 2 rods 90 x 60 L = 2610 mm, joint, internal reinforcement, hollow cover profile and shock-proof rubber profile.
002 <b>RSE</b>	Interface card for controlling two operators or for enabling the Came Remote Protocol.
001 <b>R700</b>	Control board for decoding and access-control management via transponder selector.
001 <b>R800</b>	Control board for decoding and access-control management via keypad selectors.
<b>803XA-0300</b>	Auxiliary contacts unit for detecting the boom position
<b>803XA-0280</b>	Luminous red/green LED crown.
001 <b>G02802</b>	Support for fitting DIR-series photocells.
<b>803XC-0020</b>	Modbus TCP/RTU bridge for integration with third party systems.
001 <b>PSRT01</b>	Heater kit with thermostat.
<b>806XG-0080</b> 	BUS expansion module with 2 inputs and 2 outputs. Inputs can be configured in NO, NC or resistive mode (8K2), a warning light output and a relay output.



NOTES:  
001G02802 It cannot be used with a boom equipped with a skirt or swing rest  
803XA-0640 cannot be used with 803XA\_0350, 803XA-0340 e 803XA-0330.

Code	Description
Accessories for: 803XA-0270	
<b>803XA-0320</b>	Detachable boom attachment. After impact, the pivot coupling releases the rod and the end rests on the ground.
<b>803XA-0310</b>	HD (Heavy Duty) joint for 90 x 60 mm boom.
001 <b>G02807</b>	Fixed rest.
<b>803XA-0360</b>	Magnetic lock for boom and fixed support.
<b>803XA-0330</b>	Swing rest.
<b>803XA-0340</b>	Painted aluminum skirt. 1720 mm module complete with junction brackets.
<b>803XA-0350</b>	Full height skirt in painted aluminum. 1720 mm module, H =1300 mm, complete with junction brackets.
<b>803XA-0440</b>	Swing rest - skirt support bracket.
001 <b>G02809</b>	Package of 20 red, reflective, adhesive strips.
<b>803XA-0020</b>	Red/green LED strips for booms up to 4-m long.
<b>803XA-0150</b>	Red/green LED strip for booms up to 3 m long.
<b>803XA-0230</b>	Red/green LED strip for booms up to 5 m long.
<b>803XA-0160</b>	Red/green LED strip for jointed HD (Heavy Duty) boom up to 2 m long.
<b>803XA-0190</b>	LED strips connection kit for HD jointed booms (Heavy Duty).
<b>803XA-0450</b>	Steel support for road signs.



## ATTENTION

- 803XA-0340 - Standard skirt:**  
 - Max. 2 modules for 4-meter boom.  
**803XA-0350 - Full height skirt:**  
 - Max. 2 modules for 4-meter boom.

When the passage width clearance is greater than 3 m, it is compulsory to use a boom rest to support it (fixed or movable).  
 With boom over 3.5 meters, LED strip and single skirt it is mandatory to use the fixed support.  
 With boom over 3.25 meters, LED strip and full-height skirt it is mandatory to use the fixed support.  
 803XA-0310 and 803XA-0320 cannot be installed together.

# THE COMPLETE RANGE

Code	Description
------	-------------

<b>24 V DC accessories for barriers</b>	
---	--

<b>803XA-0290</b>	Control card kit for operating during power outages and for recharging batteries, with battery housing.
-------------------	---

24  
+

<b>806XG-0030</b>	Opening and safety detector with laser technology.
-------------------	--

24  
+

<b>009SMA</b>	Single.-channel magnetic sensor for detecting metal masses.
---------------	---

24  
+

<b>009SMA2</b>	Two-channel magnetic sensor for detecting metal masses.
----------------	---

24  
+

<b>Accessories for: 806XG-0030</b>	
------------------------------------	--

<b>818XG-0019</b>	Remote control for opening and safety detector.
-------------------	---

<b>806XG-0050</b>	Steel support for opening detector and barrier safety.
-------------------	--

<b>806XG-0040</b>	24 V DC power supply for opening and safety detector.
-------------------	---



NOTES:  
803XA-0290 - No. 2 12 V – 7 Ah batteries, not supplied.



## FITTED FOR BALANCING SPRING

Point A, B and C are the springs' fastening points, depending on the clearance width.

The spring attachment points A, B and C refer to the table above.

BOOM COMPOSITION	LATERAL CLEARANCE WIDTH (m)					
	2,25 < 2,75	2,75 < 3,25	3,25 < 3,50	3,50 < 3,75	3,75 < 4,00	4,00 < 5,00
Boom with LED strip	A	A	A	B	B	C
Boom with LED strip and single skirt	A	B	B	C	C	-
Boom with LED strip and full-height skirt	A	B	C	C	C*	-
Boom with LED strip and swing rest	-	-	B	B	C	-
Boom with LED strip, single skirt and swing rest	B	B	C	C*	-	-
Boom with LED strip, full-height skirt and swing rest	B	C	C*	-	-	-

\* The boom must be stabilized at 60° opening during the balancing procedure.



## SINGLE SPRING BALANCING

CAME's R&D department has developed a practical variable balancing system, which allows using a single spring that can be connected to the balancing lever at different predefined points. It is therefore no longer necessary to have specific springs for the different boom lengths, but it is sufficient to operate on the hooking system.



## SIMPLE CONFIGURATION

The control board is positioned directly under the cabinet cover. All the configuration and maintenance phases can therefore be carried out comfortably standing upright, with the cabinet closed, in complete safety.



## FULL-HEIGHT FOLDING SKIRT

Suitable for both residential and industrial use, the folding skirt is the ideal solution to prevent access by pedestrians or unauthorized vehicles. GARD GT4 can be equipped not only with a lower skirt, but also with a special full-height solution that can be fully folded to close the gate to a height of 130 cm. This accessory is made of aluminum with white/red painted strips.

# GARD PX

Automatic barriers



PASSAGE WIDTH CLEARANCE	MCBF	USE	SPEED
UP TO 3.8 m	10 MILLION CYCLES	CONTINUOUS OPERATION	FROM 1 TO 2 SEC



## Specific solution for parking facilities and intensive duty cycles

- Brushless motor for high performance and silent operation.
- Continuous use tested for 10 million cycles (MCBF - mean cycle between failures).
- Modern design with galvanized steel cabinet with rough finish.
- Extended range power supply 120 - 230 V AC for energy saving in stand-by mode.
- Boom casing for protection against shearing in opening and closing.
- Available with high visibility red/green LEDs on the crown and on both sides of the boom.
- Available accessory for boom safety release in case of impact for high traffic applications.
- Control board with display.
- Developed with CONNECT technology for remote digital control via gateway or locally via CAME KEY.

## Dimensions (mm)

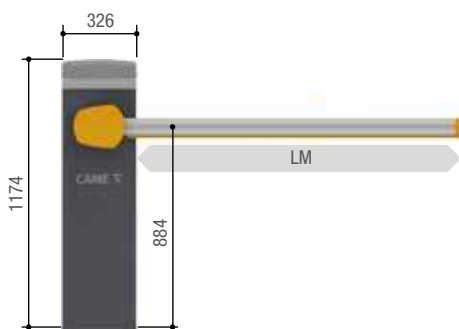

LM = Max. net clearance width

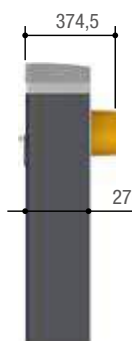

803XA-0180

## Operational limits

MODELS	803BB-0120
Max. net clearance width (m)	3,8

## Technical characteristics

MODELS	803BB-0120
Protection rating (IP)	54
Power supply (V - 50/60 Hz)	100 AC ÷ 240 AC
Power supply to motor (V)	36 DC
Power (W)	270
Opening time at 90° (s)	1 ÷ 2
Duty/cycle (%)	CONTINUOUS SERVICE
Operating temperature (°C)	-20 ÷ +55 (-40 with item 803XA-0260)
RAL color	7043

● 36 V DC

## Code Description

### Barriers with Brushless motor and built-in control panel

**803BB-0120** GPX40MGS - Automatic barrier with irreversible brushless operator; painted galvanized steel cabinet.



### Accessories for: 803BB-0120

**803XA-0050** White painted aluminum boom, 90 x 35 mm, with groove cover-strip and shock-proof rubber profile. Length: 4050 mm.



**803XA-0051** White painted aluminum boom, 90 x 35 mm, with groove cover strip and shock-proof rubber profile. Length: 3050 mm.



**002RSE** Interface card for controlling two operators or for enabling the Came Remote Protocol.



**001R700** Control board for decoding and access-control management via transponder selector.



**001R800** Control board for decoding and access-control management via keypad selectors.



**803XA-0140** Luminous red/green LED crown.



**803XA-0200** Auxiliary contacts assembly.



**803XA-0260** Heating system for GARD PX.



**803XC-0020** Modbus TCP/RTU bridge for integration with third party systems.



### Balancing springs

**001G02040** Balancing spring Ø 40 mm.

**001G04060** Balancing spring Ø 50 mm.

**001G06080** Balancing spring Ø 55 mm.



# THE COMPLETE RANGE

Code	Description
Accessories for: 803XA-0050 - 803XA-0051	
<b>803XA-0020</b>	Red/green LED strips for booms up to 4-m long.
<b>803XA-0150</b>	Red/green LED strip for booms up to 3 m long.
<b>803XA-0160</b>	Red/green LED strip for jointed HD (Heavy Duty) boom up to 2 m long.
<b>803XA-0190</b>	LED strips connection kit for HD jointed booms (Heavy Duty).
<b>803XA-0180</b>	HD (Heavy Duty) joint for 90 x 35 mm boom.
<b>803XA-0620</b>	Detachable boom attachment 90 x 35 mm. After impact, the pivot coupling releases the rod and the end rests on the ground.
001 <b>G02807</b>	Fixed rest.
001 <b>G02809</b>	Package of 20 red, reflective, adhesive strips.
24 V accessories for: 803BB-0120	
<b>806SA-0100</b> 24	Control card kit for operating during power outages and for recharging batteries, with battery housing.
009 <b>SMA</b> 24	Single.-channel magnetic sensor for detecting metal masses.
009 <b>SMA2</b> 24	Two-channel magnetic sensor for detecting metal masses.





## FITTED FOR BALANCING SPRINGS

Point A and B are the springs' fastening points, depending on the clearance width.

The spring attachment points A and B refer to the table above.

### IMPORTANT:

In case of installation of the 803XA-0180 joint, consult the technical manual for selecting the spring.

### SPRING SELECTION GUIDE FOR 803XA-0050 – 803XA-0051 BOOM

MODELS	LATERAL CLEARANCE WIDTH (m)			
	1,5 ÷ 1,75	1,75 ÷ 2,25	2,25 ÷ 2,75	2,75 ÷ 3,75
SPRING FASTENING HOLE	● A	● B	● A	● B
Boom with shock-resistant fender	●	●	●	●
Boom with shock-proof profile and LED strip	●	●	●	●

### ATTENTION

\* For maximum clearances greater than 3 m, you must use the G02807 fixed rest.



## LUMINOUS BOOM, MAXIMUM SAFETY

The new GARD PX Brushless barriers let you install, as an accessory, the special luminous crown that uses red and green light to signal the boom's position.

# GARD 5000

Automatic barriers



PASSAGE WIDTH CLEARANCE	MCBF	USE	SPEED
UP TO 5 m	1.2 MILLION CYCLES	INTENSIVE USE	FROM 4 TO 8 SEC



## Specific solution for access points with heavy traffic

- 24 V DC gearmotor with encoder is the ideal solution to ensure heavy-duty service levels.
- Linear design with galvanized steel cabinet with rough finish.
- Flashing light and photocells that can be installed directly on the cabinet.
- Control board with display.
- Developed with CONNECT technology for remote digital control via gateway or locally via GAME KEY.

## Dimensions (mm)

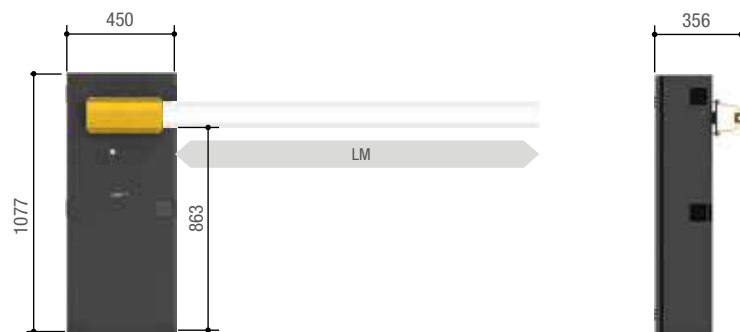

LM = Max. net clearance width

## Operational limits

MODELS	G5000
Max. net clearance width (m)	5

## Technical characteristics

MODELS	G5000
Protection rating (IP)	54
Power supply (V - 50/60 Hz)	230 AC
Power supply to motor (V)	24 DC
Power (W)	300
Opening time at 90° (s)	4 ÷ 8
Duty/cycle (%)	HEAVY-DUTY SERVICE
Operating temperature (°C)	-20 ÷ +55
RAL color	7043

## Code Description

### Barriers with 24 V DC gearmotor and built-in control panel

**001G5000** Barrier with encoder made of galvanized painted steel ready to fit accessories. The barrier includes balancing springs (two item 001G04060).



### Accessories for: 001G5000

**001G0502** White painted aluminum tube-section boom. Ø 100 mm, boom length: 5.35 m.



**001G05350** White painted aluminum tube-section boom with rubber groove-covering profile. Ø 100 mm, boom length: 5.35 m.



**002RSE** Interface card for controlling two operators or for enabling the Came Remote Protocol.



**001R800** Control board for decoding and access-control management via keypad selectors.



**001R700** Control board for decoding and access-control management via transponder selector.



**001PSRT01** Heater kit with thermostat.



**001G0468** Brace for fitting DLX photocells onto the cabinet.



**001G04601** Adapter for fitting the KIARO-series flashing light; requires the KIAROS base).



### Accessories for: 001G05350

**803XC-0010** Interface for STRIP LED.



**803XA-0230** Red/green LED strip for booms up to 5 m long.



### Accessories for: 001G0502 - 001G05350

**001G0465** Painted aluminum skirt (modules L = 2 m).



**803XA-0330** Swing rest.



**001G02807** Fixed rest.



**001G02809** Package of 20 red, reflective, adhesive strips.



### 24 V accessories for: 001G5000

**002LB39** Circuit board for emergency operation and battery charging.



**009SMA** Single.-channel magnetic sensor for detecting metal masses.



**009SMA2** Two-channel magnetic sensor for detecting metal masses.



PASSAGE WIDTH CLEARANCE	MCBF	USE	SPEED
UP TO 6.5 m	1 MILLION CYCLES	INTENSIVE USE	FROM 4 TO 8 SEC



### Ideal solution for use in apartment buildings and industrial plants

- 24 V DC gearmotor ideal to ensure heavy-duty service levels.
- Linear design with galvanized steel cabinet with RAL 2004 rough finish.
- Also available made of AISI 304 steel (item G6501).

### Dimensions (mm)

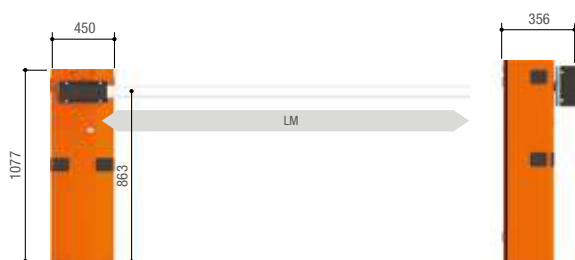

001G6500  
001G6501  
001G6000

LM = Max. net clearance width

### Operational limits

MODELS	G6500	G6501	G6000	G6001
Max. net clearance width (m)	6,5	6,5	6,5	6,5

### Technical characteristics

MODELS	G6500	G6501	G6000	G6001
Protection rating (IP)	54	54	54	54
Power supply (V - 50/60 Hz)	230 AC	230 AC	230 AC	230 AC
Power supply to motor (V)	24 DC	24 DC	24 DC	24 DC
Absorption (A)	15 Max.	15 Max.	15 Max.	15 Max.
Power (W)	300	300	300	300
Opening time at 90° (s)	4 ÷ 8	4 ÷ 8	4 ÷ 8	4 ÷ 8
Duty/cycle (%)	HEAVY-DUTY SERVICE	HEAVY-DUTY SERVICE	HEAVY-DUTY SERVICE	HEAVY-DUTY SERVICE
Torque (Nm)	600	600	600	600
Operating temperature (°C)	-20 ÷ +55	-20 ÷ +55	-20 ÷ +55	-20 ÷ +55
Motor's heat protection (°C)	-	-	-	-
RAL color	2004	-	2004	-

● 230 V AC ● 24 V DC

Code	Description
<b>Barriers with 24 V DC gearmotor and built-in control panel</b>	
001 <b>G6500</b> 	Galvanized, painted steel and set up for fitting accessories.
001 <b>G6501</b> 	Barrier made of satin-coated AISI 304 stainless steel, set up for fitting accessories.
<b>Accessories for: 001G6500 - 001G6501</b>	
001 <b>G0602</b>	White, painted aluminum, tube-section boom. Ø 100 mm, boom length: 6.85 m.
001 <b>G06850</b>	White, painted aluminum, tube-section boom, with rubber groove covering profile and internal reinforcement. Ø 100 mm, boom length: 6.85 m.
001 <b>G0468</b>	Brace for fitting DLX photocells onto the cabinet.
001 <b>G04601</b>	Adapter for fitting the KIARO-series flashing light; requires the KIAROS base).
001 <b>PSRT01</b>	Heater kit with thermostat.
<b>Balancing springs</b>	
001 <b>G02040</b>	Balancing spring Ø 40 mm.
001 <b>G04060</b>	Balancing spring Ø 50 mm.
001 <b>G06080</b>	Balancing spring Ø 55 mm.
<b>Accessories for: 001G0602 - 001G06850</b>	
001 <b>G0465</b>	Painted aluminum skirt (modules L = 2 m).
001 <b>G02807</b>	Fixed rest.
<b>803XA-0330</b>	Swing rest.



# THE COMPLETE RANGE

Code	Description
------	-------------

Accessories for: 001G06850

<b>803XC-0010</b>	Interface for STRIP LED.
-------------------	--------------------------

<b>803XA-0240</b>	Red/green LED strip for booms up to 6.5 m long.
-------------------	---

001 <b>G02809</b>	Package of 20 red, reflective, adhesive strips.
-------------------	---



24 V accessories for: 001G6500 - 001G6501

002 <b>LB39</b>	Circuit board for emergency operation and battery charging.
-----------------	---



009 <b>SMA</b>	Single.-channel magnetic sensor for detecting metal masses.
----------------	---



009 <b>SMA2</b>	Two-channel magnetic sensor for detecting metal masses.
-----------------	---



NOTES:  
002LB39 - No. 2 12 V – 7 Ah batteries, not supplied.

Code	Description
<b>Barriers with 24 V DC gearmotor and built-in control panel</b>	
001 <b>G6000</b> 	Galvanized, painted steel and set up for fitting accessories.
001 <b>G6001</b> 	Barrier made of satin-coated AISI 304 stainless steel, set up for fitting accessories.
<b>Accessories for: 001G6000 - 001G6001</b>	
001 <b>G0601</b>	White painted aluminum boom with end cap. Section 40 x 100 mm, boom length: 6.85 m.
001 <b>G0602</b>	White, painted aluminum, tube-section boom. Ø 100 mm, boom length: 6.85 m.
001 <b>G0468</b>	Brace for fitting DLX photocells onto the cabinet.
001 <b>G04601</b>	Adapter for fitting the KIARO-series flashing light; requires the KIAROS base).
<b>Accessories for: 001G0601 - 001G0602</b>	
001 <b>G0465</b>	Painted aluminum skirt (modules L = 2 m).
001 <b>G0461</b>	Package of 24 red, reflective, adhesive strips.
<b>Accessories for: 001G0601</b>	
001 <b>G0603</b>	Red rubber shock-proof edge with end caps.
001 <b>G0460</b>	Pack of six 24 V light bulbs.
<b>Accessories for: 001G0602</b>	
001 <b>G0605</b>	Fastening flange.
<b>24 V accessories for: 001G6000 - 001G6001</b>	
002 <b>LB39</b> 	Circuit board for emergency operation and battery charging.
009 <b>SMA</b> 	Single.-channel magnetic sensor for detecting metal masses.
009 <b>SMA2</b> 	Two-channel magnetic sensor for detecting metal masses.



NOTES:  
002LB39 - No. 2 12 V – 7 Ah batteries, not supplied.

## 001G6500 - 001G6501

### Spring Selection Guide for 001G06850 boom

MODELS	<span style="color: yellow;">●</span> Springs 001G02040 Ø 40 mm <span style="color: green;">●</span> Springs 001G04060 Ø 50 mm <span style="color: red;">●</span> Springs 001G06080 Ø 55 mm								
	LATERAL CLEARANCE WIDTH (m)								
BOOM COMPOSITION	2 ÷ 2,5	2,5 ÷ 3	3 ÷ 3,5	3,5 ÷ 4	4 ÷ 4,5	4,5 ÷ 5	5 ÷ 5,5	5,5 ÷ 6	6 ÷ 6,5
Boom	●	●	●	●●	●	●●	●●	●●	●●
Boom with swing-leg 803XA-0330	●	●	●●	●●	●●	●●	●●	●●	●●
Boom with 001G028401 luminous cord	●	●	●●	●●	●●	●●	●●	●●	●●
Boom with 803XA-0330 swing rest and 001G028401 luminous cord	●	●●	●●	●	●●	●●	●●	●●	●●
Boom with 001G0465 skirt	●	●	●●	●	●●	●●	●●	●●	●●
Boom with 001G0465 skirt and 001G028401 luminous cord	●	●●	●●	●●	●●	●●	●●	●●	●●

### ATTENTION

001G0468 Cannot be used on barriers with the 001G0465 skirt or 803XA-0330 swing rest.



# GARD GT8

Automatic barriers



PASSAGE WIDTH CLEARANCE	MCBF	USE	SPEED
UP TO 7.8 m	3 MILLION CYCLES	160 CYCLES/HOUR	FROM 4 TO 8 SEC



## Ideal solution for applying in private homes and industrial plants

- 24 V DC operator with Advanced Speed Control.
- Tested for intensive use of 160 cycles/hour with MCBF 3 million cycles.
- Cabinet available in galvanized steel and painted RAL7024, AISI 304 and AISI 316 steel, or in customized color.
- Control board with display, CONNECT technology and inputs for CXN BUS accessories.
- Accessories that can be integrated directly into the cabinet.
- High visibility red/green LEDs on the crown and on both sides of the boom.
- It can be integrated with third party systems through MODBUS protocol.

## Dimensions (mm)

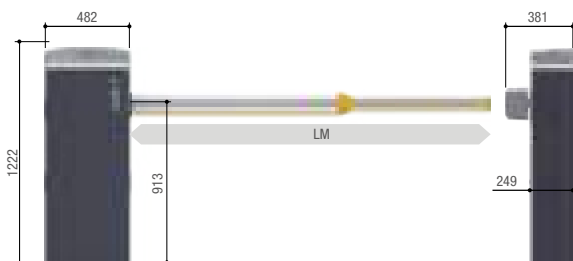

LM = Max. net clearance width

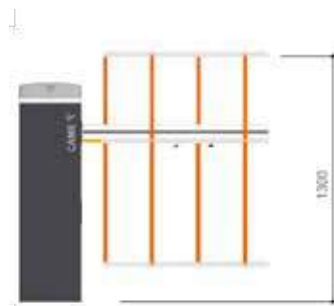

803XA-0350

## Operational limits

MODELS	803BB-0180	803BB-0290	803BB-0250	803BB-0270
Max. net clearance width (m)	7,8	7,8	7,8	7,8

## Technical characteristics

MODELS	803BB-0180	803BB-0290	803BB-0250	803BB-0270
Protection rating (IP)	54	54	54	54
Power supply (V - 50/60 Hz)	230 AC	230 AC	230 AC	230 AC
Power supply to motor (V)	24 DC	24 DC	24 DC	24 DC
Power (W)	300	300	300	300
Opening time at 90° (s)	4 ÷ 8	4 ÷ 8	4 ÷ 8	4 ÷ 8
Cycles/Hour	160	160	160	160
Operating temperature (°C)	-20 ÷ +55 (-40 with item 001PSRT01)	-20 ÷ +55 (-40 with item 001PSRT01)	-20 ÷ +55 (-40 with item 001PSRT01)	-20 ÷ +55 (-40 with item 001PSRT01)
RAL color	7024	RAL X	-	-

● 24 V DC















Code	Description
------	-------------

230 V AC barriers with encoder and 24 V DC operator and built-in control panel	
<b>803BB-0180</b> 	GGT80AGS - Automatic barrier with irreversible 24 V DC operator with encoder; galvanized steel and painted cabinet with set up for fitting accessories. Balancing springs included.
<b>803BB-0290</b> 	GGT80ACS - Automatic barrier with irreversible 24 V DC operator with encoder; galvanized steel cabinet with customized RAL painting and set up for fitting accessories. Balancing springs included.
<b>803BB-0250</b> 	GGT80AX4 - Automatic barrier with irreversible 24 V DC operator with encoder; AISI 304 satin-finish steel cabinet with set up for fitting accessories. Balancing springs included.
<b>803BB-0270</b> 	GGT80AX6 - Automatic barrier with irreversible 24 V DC operator with encoder; AISI 316 satin-finish steel cabinet with set up for fitting accessories. Balancing springs included.



# THE COMPLETE RANGE

## Code Description

Code	Description	
<b>Accessories for barriers</b>		
<b>803XA-0400</b>	White painted aluminum boom, 130 x 85 mm, with internal reinforcement, groove cover-strip and shock-proof rubber profile. Length: 4340 mm.	
<b>803XA-0410</b>	White painted aluminum boom, 130 x 85 mm, with internal reinforcement, groove cover-strip and shock-proof rubber profile. Length: 6350 mm.	
<b>803XA-0420</b>	White painted aluminum modular boom, complete with cap, composed by: no. 1 boom 90 x 60 L = 4220 mm, no. 1 boom 130 x 85 L = 4340 mm, hollow cover profiles and shockproof rubber profile.	
002 <b>RSE</b>	Interface card for controlling two operators or for enabling the Came Remote Protocol.	
001 <b>R700</b>	Control board for decoding and access-control management via transponder selector.	
001 <b>R800</b>	Control board for decoding and access-control management via keypad selectors.	
<b>803XA-0380</b>	Auxiliary contacts unit for detecting the boom position	
<b>803XA-0430</b>	Luminous red/green LED crown.	
<b>803XA-0240</b>	Red/green LED strip for booms up to 6.5 m long.	
<b>803XA-0250</b>	Red/green LED strip for booms up to 8 m long.	
001 <b>G02802</b>	Support for fitting DIR-series photocells.	
<b>803XC-0020</b>	Modbus TCP/RTU bridge for integration with third party systems.	
001 <b>PSRT01</b>	Heater kit with thermostat.	
<b>806XG-0080</b>	BUS expansion module with 2 inputs and 2 outputs. Inputs can be configured in NO, NC or resistive mode (8K2), a warning light output and a relay output.	

NOTES:  
001G02802 It cannot be used with a boom equipped with a skirt or swing rest

Code	Description
Accessories for: 803XA-0400 - 803XA-410	
<b>803XA-0350</b>	Full height skirt in painted aluminum. 1720 mm module, H =1300 mm, complete with junction brackets.
Accessories for: 803XA-0400 - 803XA-0410 - 803XA-0420	
001 <b>G02807</b>	Fixed rest.
<b>803XA-0360</b>	Magnetic lock for boom and fixed support.
<b>803XA-0330</b>	Swing rest.
<b>803XA-0340</b>	Painted aluminum skirt. 1720 mm module complete with junction brackets.
<b>803XA-0390</b>	Detachable attachment for 130 x 85 mm boom. After impact, the pivot coupling releases the rod and the end rests on the ground.
001 <b>G02809</b>	Package of 20 red, reflective, adhesive strips.
<b>803XA-0440</b>	Swing rest - skirt support bracket.
<b>803XA-0450</b>	Steel support for road signs.



NOTES:  
 The fixed rest for boom 001G02807 must OBLIGATORILY be used for clearance widths greater than 7 m.  
 The swing rest 803XA-0330 is for a clearance width up to 7 m.

## ATTENTION

803XA-0340 - Standard rack: Max. 2 modules for 4 metres of boom; Max. 3 modules for 6 metres of boom; 4 modules up to max. 7 metres of boom.  
 803XA-0350 - Full Height Rack: Max. 2 modules per 4 metres of boom; Max. 3 modules per 6 metres of boom; Not compatible with modular boom 803XA-0420.  
 When the passage width clearance is greater than 4 m, it is compulsory to use a boom rest to support it (fixed or movable).  
 803XA-0390: Not compatible with skirts 803XA-0350 - 803XA-0340. Maximum boom length: 6 m.

# THE COMPLETE RANGE

Code	Description
<b>24 V DC accessories for barriers</b>	
<b>803XA-0370</b> +24 -	Control card kit for operating during power outages and for recharging batteries, with battery housing.
<b>806XG-0030</b> +24 -	Opening and safety detector with laser technology.
009SMA +24 -	Single.-channel magnetic sensor for detecting metal masses.
009SMA2 +24 -	Two-channel magnetic sensor for detecting metal masses.
<b>Accessories for: 806XG-0030</b>	
<b>818XG-0019</b>	Remote control for opening and safety detector.
<b>806XG-0050</b>	Steel support for opening detector and barrier safety.
<b>806XG-0040</b>	24 V DC power supply for opening and safety detector.



NOTES:  
803XA-0370 - No. 2 12 V - 7 Ah batteries not supplied.

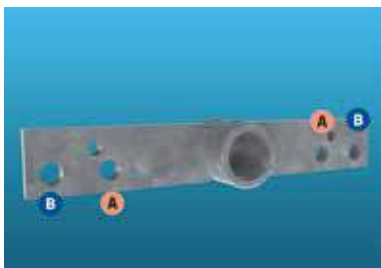

## FITTED FOR BALANCING SPRINGS

Point A and B are the springs' fastening points, depending on the clearance width.

The spring attachment points A and B refer to the table above.

BOOM COMPOSITION	LATERAL CLEARANCE WIDTH (m)						
	4,00 < 4,50	4,50 < 5,00	5,00 < 5,50	5,50 < 6,00	6,00 < 6,50	6,50 < 7,00	7,00 < 7,80
Boom with LED strip	A	A	B	A A	A A	A A	B B
Boom with LED strip and single skirt	B	A A	A A	B B	B B	B B	-
Boom with LED strip and full-height skirt	A A	A A	B B	B B	-	-	-
Boom with LED strip and swing rest	A	B	A A	A A	A A	A A	-
Boom with LED strip, single skirt and swing rest	A A	A A	A A	B B	-	-	-
Boom with LED strip, full-height skirt and swing rest	A A	B B	B B	-	-	-	-

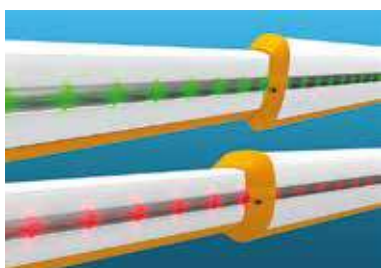

## LUMINOUS BOOM, MAXIMUM SAFETY

The new GARD GT8 barriers incorporate as an accessory, the luminous warning device with green or red light, depending on the position of the boom.



## SIMPLE CONFIGURATION

The control board is positioned directly under the cabinet cover. All the configuration and maintenance phases can therefore be carried out comfortably standing upright, with the cabinet closed, in complete safety.



## FULL-HEIGHT FOLDING SKIRT

Suitable for both residential and industrial use, the folding skirt is the ideal solution to prevent access by pedestrians or unauthorized vehicles. GARD GT8 can be equipped not only with a lower skirt, but also with a special full-height solution that can be fully folded to close the gate to a height of 130 cm. This accessory is made of aluminum with white/red painted strips.

# GARD 12

+  
24  
-  
24 V

## Automatic barriers

PASSAGE WIDTH CLEARANCE	MCBF	USE	SPEED
UP TO 12 m	600,000 CYCLES	50 %	10 S



## Specific solution for special applications

- Two 24 V DC gearmotors installed on the same axis to offer greater drive torque.
- Balancing with modular counterweights, it guarantees a safe and reliable movement of the boom.
- Sturdy structure with galvanized steel cabinet with rough finish.

## Dimensions (mm)

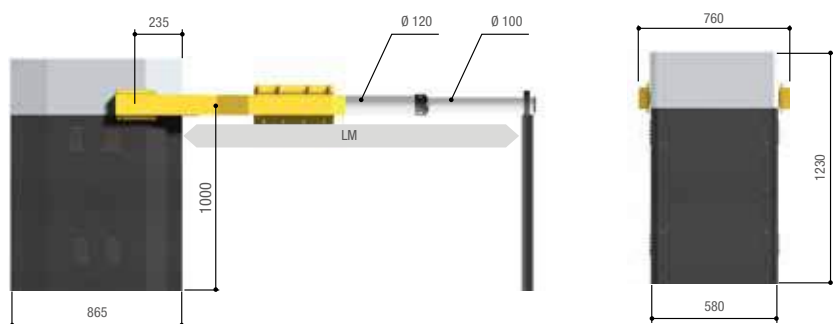

LM = Max. net clearance width

## Operational limits

MODELS	G12000K
Max. net clearance width (m)	12

## Technical characteristics

MODELS	G12000K
Protection rating (IP)	54
Power supply (V - 50/60 Hz)	230 AC
Power supply to motor (V)	24 DC
Absorption (A)	15 Max.
Power (W)	300
Opening time at 90° (s)	10
Duty/cycle (%)	50
Torque (Nm)	600
Operating temperature (°C)	-20 ÷ +55
RAL color	7043

● 24 V DC

Code	Description
------	-------------

<b>Barriers with 24 V DC gearmotor and built-in control panel</b>	
---	--

001 <b>G12000K</b>	Barrier made of painted, galvanized steel.
--------------------	--



<b>Accessories for: 001G12000K</b>	
------------------------------------	--

001 <b>G0121</b>	White painted aluminum tube boom, with end cap, made up of: L one fixed rest, one tube boom L = 6,200 mm Ø 120 mm, one tube boom L = 6,000 mm Ø 100 mm, one boom extender accessory.
------------------	--

001 <b>G1325</b>	Package of 20 counter-weights.
------------------	--------------------------------



<b>Accessories for: 001G0121</b>	
----------------------------------	--

001 <b>G0461</b>	Package of 24 red, reflective, adhesive strips.
------------------	---



<b>24 V accessories for: 001G12000K</b>	
---	--

002 <b>LB38</b>	Circuit board for emergency operation and battery charging.
-----------------	---



009 <b>SMA</b>	Single.-channel magnetic sensor for detecting metal masses.
----------------	---



009 <b>SMA2</b>	Two-channel magnetic sensor for detecting metal masses.
-----------------	---



NOTES:

002LB38 - Three 12 V - 7 Ah batteries (not supplied), set up a suitable external battery housing that can fit in the barrier cabinet on: 001G12000K

PARKING SPACE MAXIMUM WIDTH	SPACES EXTENSION	USE
UP TO 2.45 m	MAX 4	INTENSIVE

## Parking saver for residential settings and public spaces



- Solution controllable via radio, to reserve the parking space.
- Simple and functional fixing base.
- It works in emergency mode during power outages.
- Safety is ensured by the amperometric obstruction-detecting and limit-switch controlling device.
- Available in 2 models: small and large.
- Built in galvanized steel and painted RAL 1028 with textured finish.

### Dimensions (mm)

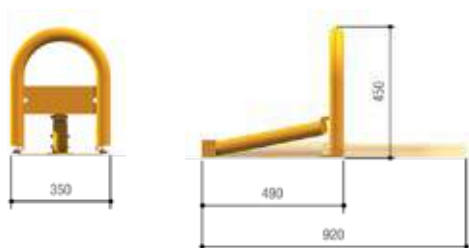

001UNIP  
001ARK1

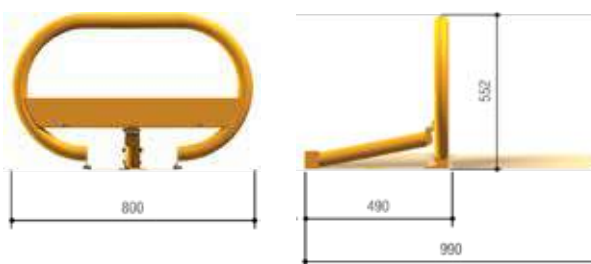

001UNIP  
001ARK2





### Operational limits

MODEL	UNIP + ARK1	UNIP + ARK2
Max clearance width of parking space (m)	2	2,45

NOTE: Colore RAL 1028

### Technical characteristics

MODELS	UNIP
Protection rating (IP)	54
Power supply (V - 50/60 Hz)	230 AC
Power supply to motor (V)	24 AC
Absorption (A)	1,7 Max.
Power (W)	20
Duty/cycle (%)	HEAVY-DUTY SERVICE
Resistance to crushing (kg/cm <sup>2</sup> )	2,5
Operating temperature (°C)	-20 ÷ +55

Code	Description
<b>Parking guard barriers with 24 V DC gearmotor</b>	
001 <b>UNIP</b> 	Irreversible gearmotor with fastening plate.
<b>Extra accessories</b>	
001 <b>ARK1</b>	SMALL barrier.
001 <b>ARK2</b>	LARGE barrier.
<b>Control panels for 24 V DC gearmotors</b>	
801 <b>QA-0030</b> 	ZL22N - Control panel for one parking saver barrier, extensible up to 4 barriers with no. 3 LM22N boards.
<b>Accessories for: 801QA-0030</b>	
801 <b>XC-0110</b> 	LM22N - Extension board for one motor.
002 <b>LB22</b> 	Circuit board for emergency operation and battery charging.



NOTES:  
002LB22 - No. 2 12 V - 1.2 Ah batteries, not supplied.

PASSAGE WIDTH CLEARANCE	CHAIN TYPE	USE
UP TO 16 m	5 OR 9 mm	INTENSIVE



## Solution for access management in private and public settings

- CAME patented device for the management of reserved areas and private accesses.
- Sturdy and impact-resistant steel structure.
- Quick and simple installation.
- Guides to guarantee the chain protection with open passage.
- Available version with 24 V DC motor and CAME CONNECT technology.

### Dimensions (mm)

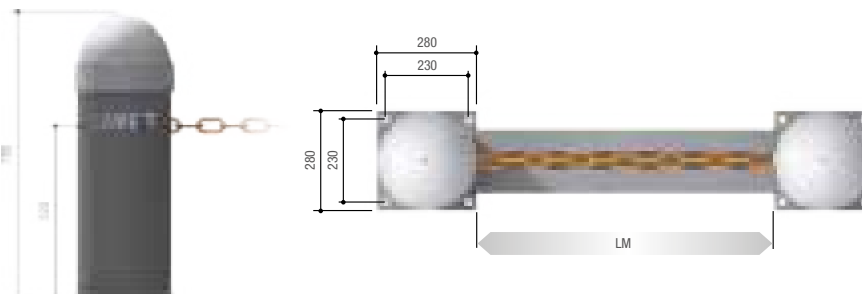

LM = Max. net clearance width

### Operational limits

MODEL	CAT-15 (5 mm chain)	CAT-5 (9 mm chain)
Max. net clearance width (m)	16	8

NOTE: Cover color RAL 7040 - Cabinet color RAL 7024

### Technical characteristics

MODELS	803BC-0010	803BC-0040	803BC-0020	803BC-0050
Protection rating (IP)	24	24	24	24
Power supply (V - 50/60 Hz)	220-230 AC	220-230 AC	220-230 AC	220-230 AC
Power supply to motor (V)	230 AC	230 AC	24 DC	24 DC
Absorption (A)	3,8	3,8	2,7	2,7
Power (W)	880	880	540	540
Operating temperature (°C)	-20 ÷ +55	-20 ÷ +55	-20 ÷ +55	-20 ÷ +55

● 230 V AC ● 24 V DC

## Code Description

Chain barriers with 230 V AC motor	
<b>803BC-0010</b> 	Pillar with 230 V gear motor and built-in control panel.
<b>803BC-0040</b> 	Pillar with 230 V gear motor and built-in control panel; galvanised steel column, customised RAL painted.
Chain barriers with 24 V DC motor	
<b>803BC-0020</b> 	Column with 24 V gearmotor and built-in control panel.
<b>803BC-0050</b> 	Column with 24 V geared motor and built-in control panel; customised RAL painted galvanised steel column.
Column for chain barriers	
<b>803BC-0030</b> 	Post with counter-weight and chain latch.
<b>803BC-0060</b> 	Column with counterweight and chain coupling; galvanised steel column, customised RAL painted.
Accessories	
001 <b>CAT-5</b>	Genovese-type, 9 mm chain for clearances of up to 8 m.
001 <b>CAT-15</b>	Genovese-type, 5 mm chain for clearances of up to 16 m.
001 <b>CAR-2</b>	Above-round, chain protection guide L = 2 m.
001 <b>CAR-4</b>	Below-ground, chain protection guide L = 2 m.
Accessories for 24 V versions	
002 <b>RLB</b> 	Circuit board for emergency operation and battery charging.

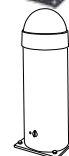
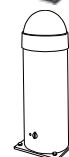
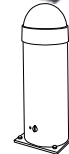

NOTES:  
002RLB No. 2 batteries 12 V - 1.2 Ah not supplied.



## ELEGANT AND CUSTOMISABLE FINISH

CAT columns are made of galvanised steel, painted in grey RAL 7024, elegant and refined for any environment, even for historical and exclusive contexts. The upper cap in light grey RAL 7040 and the steel chain orange, ensure maximum visibility and safety. CAT is available on request in a customised finish based on any RAL colour.

# CONTROL BOARD FUNCTIONS

The table shows all of the characteristics of the street barrier control-panels.  
The ones in bold type are important for choosing which operator to install and should be assessed from the start.

Models / Series	G6500 G6501 G6000 G6001	G5000	803BB-0120	803BB-0160 803BB-0280 803BB-0240 803BB-0260 803BB-0180 803BB-0290 803BB-0250 803BB-0270	803BB-0410 803BB-0430 803BB-0440 803BB-0370 803BB-0390 803BB-0400
<b>Control board / Control panel</b>	ZL39B	ZL39EX	ZL30B	ZL392B	ZL392C
<b>Safety</b>					
SELF-DIAGNOSING safety decives	●	●	●	●	●
PRE-FLASHING when opening and closing	●	●	●	●	●
REOPENING during closing	●	●	●	●	●
CLOSING AGAIN during opening				●	●
Obstruction WAIT	●	●		●	●
TOTAL STOP	●	●	●	●	●
PARTIAL STOP			●	●	●
OBSTRUCTION DETECTION in front of photocells	●	●	●	●	●
ENCODER		●	●	●	●
MOVEMENT CONTROLLING and OBSTRUCTION DETECTING device.		●	●	●	●
AMPEROMETRIC DETECTION	●	●	●	●	●
<b>Command</b>					
PEDESTRIAN OPENING 1 leaf		*			
PARTIAL OPENING 1 leaf	●	●*		●	●
OPEN ONLY from transmitter and/or from button	●	●	●	●	●
ONLY OPEN or ONLY CLOSE button connection	●	●	●	●	●
OPEN-STOP-CLOSE-STOP from the transmitter and/or button			●	●	●
OPEN-CLOSE-INVERT from the transmitter and/or button	●	●	●	●	●
MAINTAINED ACTION	●	●	●	●	●
DELAYED OPENING 1st leaf					
DELAYED OPENING 2nd leaf					
IMMEDIATE CLOSING	●	●	●	●	●
EMERGENCY RELEASE from the transmitter					
<b>Characteristics</b>					
FLASHING LIGHT connection	●	●	●	●	●
CYCLE LIGHT connection	●	●	●	●	●
COURTESY LIGHT connection	●	●	●	●	●
Antenna	●	●	●	●	●
OPEN ALERT LIGHT connection	●	●	●	●	●
CLOSED ALERT LIGHT connection				●	●
Contact output for 2nd RADIO CHANNEL					
SELF-LEARNING of the transmitter's RADIO CODE	●	●	●	●	●
OPERATING TIME adjusting		●			
ELECTROLOCK/ELECTROBLOCK connection			●	●	●
SLEEP MODE		●			
Adjustable AUTOMATIC CLOSING AGAIN TIME	●	●	●	●	●
OPENING and/or CLOSING slow downs	●	●	●	●	●
EMERGENCY BATTERY operation (optional)	●	●	●	●	●
MASTER-SLAVE	●	●	●	●	●
Adjustable TRAVEL and SLOW-DOWN speeds*	●	●	●	●	●
DISPLAY	●	●	●	●	●
Electronic brake	●				
SELF-LEARNING opening and closing limit-switches		●	●	●	●
Connection to the solar panel		●			
Compatible with CONNECT technology	●	●	●	●	●
Designed to fit RIO System 2.0					
CRP control		●	●		
ENERGY SAVINGS control (001RGP1)					
Firmware update from USB			●		
PASSWORD protecting access to functions			●	●	●
MANEUVER COUNTER	●	●	●	●	●
Number of operations setting for MAINTENANCE			●	●	●

\* Only available in paired mode

The table shows the characteristics of the parking system and chain barrier, operator-specific, control panels. The ones in bold type are important for choosing which operator to install and should be assessed from the start.

<b>Models / Series</b>	CAT 230 V	CAT 24 V	UNIPARK
<b>Control board / Control panel</b>	<b>002ZA3P-C</b>	<b>002ZN7-D</b>	<b>ZL22N</b>
<b>Safety</b>			
SELF-DIAGNOSING safety decives	●	●	
PRE-FLASHING when opening and closing	●	●	
REOPENING during closing	●	●	●
CLOSING AGAIN during opening			
Obstruction WAIT	●		
TOTAL STOP	●	●	●
PARTIAL STOP			
OBSTRUCTION DETECTION in front of photocells	●	●	
ENCODER			
MOVEMENT CONTROLLING and OBSTRUCTION DETECTING device.			
AMPEROMETRIC DETECTION		●	●
<b>Command</b>			
PEDESTRIAN OPENING 1 leaf			
PARTIAL OPENING 1 leaf			
OPEN ONLY from transmitter and/or from button	●	●	
ONLY OPEN or ONLY CLOSE button connection	●	●	
OPEN-STOP-CLOSE-STOP from the transmitter and/or button	●	●	
OPEN-CLOSE-INVERT from the transmitter and/or button	●	●	●
MAINTAINED ACTION	●	●	
DELAYED OPENING 1st leaf			
DELAYED OPENING 2nd leaf			
IMMEDIATE CLOSING			
EMERGENCY RELEASE from the transmitter			
<b>Characteristics</b>			
FLASHING LIGHT connection	●	●	
CYCLE LIGHT connection			
COURTESY LIGHT connection	●	●	
Antenna	●	●	●
OPEN ALERT LIGHT connection	●	●	
CLOSED ALERT LIGHT connection	●	●	
Contact output for 2nd RADIO CHANNEL	●		
SELF-LEARNING of the transmitter's RADIO CODE	●	●	●
OPERATING TIME adjusting	●	●	
Connection for the ELECTRIC LOCK and/or RAMMING			
SLEEP MODE			
Adjustable AUTOMATIC CLOSING AGAIN TIME	●	●	
OPENING and/or CLOSING slow downs			
EMERGENCY BATTERY operation (optional)		●	●
MASTER-SLAVE			
Adjustable TRAVEL and SLOW-DOWN speeds*		●	
DISPLAY		●	
Electronic brake			
SELF-LEARNING opening and closing limit-switches			
Connection to the solar panel			
CAME Connect		●	
Designed to fit RIO System 2.0			
CRP control			
ENERGY SAVINGS control (001RGP1)			
Firmware update from USB			

# INDUSTRIAL DOOR AUTOMATION

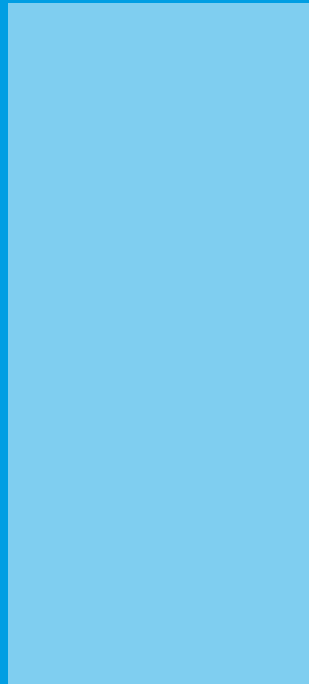

184	SELECTION GUIDE
190	F4000
192	CBX
196	H4
199	CONTROL BOARD FUNCTIONS

# Selection guide

## Industrial door automation

The table shows the series and models and their operating limits according to the max. length of the leaf or its max. height, depending on the type of application.

Series		Model	Max. width of leaf (m) / Max. weight of leaf (kg)
<b>SWING LEAF DOORS</b>			
F4000	F4024E		1,5 / 200
F4000	F40230E		2 / 300
F4000	F4024EP		2 / 300
<b>SINGLE-LEAF FOLDING DOORS</b>			
F4000	F4024E		1,2 / 150
F4000	F40230E		1,2 / 200
F4000	F4024EP		1,2 / 200
<b>SLIDING AND FOLDING SLIDING DOORS</b>			
CBX	C-BX		11
CBX	C-BXK		11
CBX	C-BXT		11
<b>SECTIONAL DOORS WITH DIRECT TRANSMISSION</b>			
CBX	C-BX		5.5
CBX	C-BXK		5.5
CBX	C-BXT		5.5
<b>CHAIN-DRIVEN SECTIONAL DOORS</b>			
CBX	C-BX		8,5
CBX	C-BXK		8,5
CBX	C-BXT		8,5

● 230 V AC ● 24 V DC ● 230 – 400 V AC THREE PHASE

## Winding shutters

The tables summarize the series and models with their maximum operating limits only according to the hoisting strength of the gearmotors for roller shutters.

Series	Model	Max. hoisting strength (kg)
H4	H40230120	120
H4	H41230120	120
H4	H40230180	180
H4	H41230180	180

● 230 V AC



## SECTIONAL DOOR

This operator is generally fitted in automated loading/unloading bays, but is often used as the main closure.



## SLIDING DOOR

This operator is widely used in industrial facilities.



## FOLDING DOOR

This operator is used to close very wide entrances while limiting, as much as possible, the space taken up laterally when the door is open.

## The flashing light for movement signaling.

CAME has always suggested installing the flashing light as an additional safety feature for the automation system. The KRX range, with LED technology, combines energy saving and great reliability with easy installation. KRX can be integrated with all CAME radio systems, is available in various colors, has a built-in radio antenna and each model can be powered from 24 V DC to 230 V AC.



# CHAIN-DRAWN SLIDING DOOR

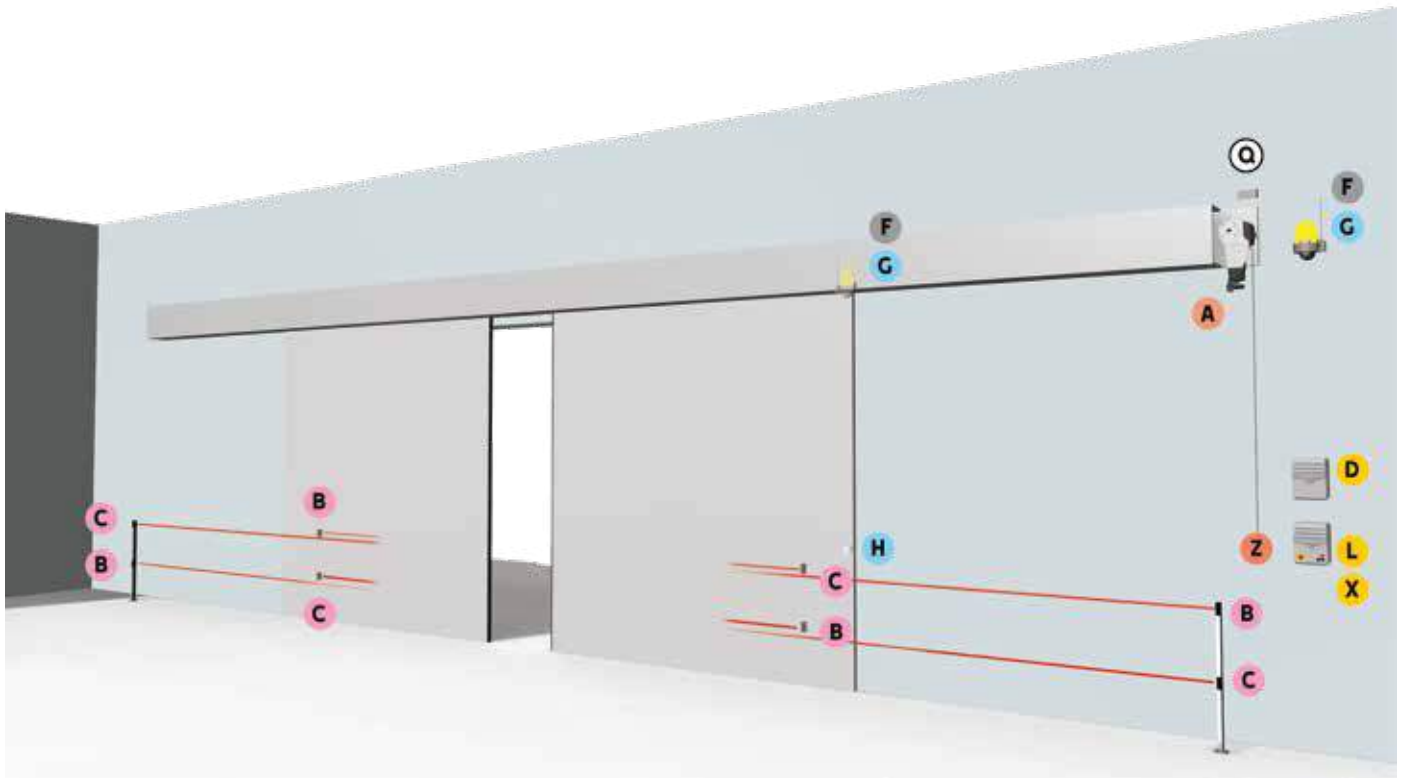

## COMPONENTS

- A** Gearmotor
- B** TX Photocells
- C** RX Photocells
- D** Control card for operating during power outages
- F** Flashing light
- G** Antenna
- H** Control switch  
(Key – Code – Card or transponder fob)
- L** Control panel
- Q** Junction box
- X** Radio frequency card
- Z** Release device

## CABLES FOR STANDARD INSTALLATIONS

LENGTH OF CABLE (m)	< 10	from 10 to 20	from 20 to 30
Power supply 230 V AC	3G x 1.5 mm <sup>2</sup>	3G x 1.5 mm <sup>2</sup>	3G x 2.5 mm <sup>2</sup>
Power supply 230 - 400 V AC three phase	4G x 1.5 mm <sup>2</sup>	4G x 1.5 mm <sup>2</sup>	4G x 2.5 mm <sup>2</sup>
Power supply to motor 230 V AC	3G x 1.5 mm <sup>2</sup>	3G x 1.5 mm <sup>2</sup>	3G x 2.5 mm <sup>2</sup>
Power supply to motor 230 - 400 V AC three phase	4G x 1.5 mm <sup>2</sup>	4G x 1.5 mm <sup>2</sup>	4G x 2.5 mm <sup>2</sup>
Power supply to motor 24 or 36 V DC	2G x 1.5 mm <sup>2</sup>	2G x 1.5 mm <sup>2</sup>	2G x 2.5 mm <sup>2</sup>
Limit switch micro-switches	*no. x 0.5 mm <sup>2</sup>	*no. x 0.5 mm <sup>2</sup>	*no. x 0.5 mm <sup>2</sup>
Flashing light 24 V AC - DC	2 x 1 mm <sup>2</sup>	2 x 1 mm <sup>2</sup>	2 x 1 mm <sup>2</sup>
Flashing light 230 V AC	2 x 1.5 mm <sup>2</sup>	2 x 1.5 mm <sup>2</sup>	2 x 1.5 mm <sup>2</sup>
TX Photocells	2 x 0.5 mm <sup>2</sup>	2 x 0.5 mm <sup>2</sup>	2 x 0.5 mm <sup>2</sup>
RX Photocells	4 x 0.5 mm <sup>2</sup>	4 x 0.5 mm <sup>2</sup>	4 x 0.5 mm <sup>2</sup>
Control devices	*no. x 0.5 mm <sup>2</sup>	*no. x 0.5 mm <sup>2</sup>	*no. x 0.5 mm <sup>2</sup>
Antenna		RG58 max 10 m	

\*no. = see product mounting instructions - Attention: the cable section is merely indicative as it depends on the motor power and cable length.



**COMPONENTS**

- A** Gearmotors
- B** TX Photocells
- C** RX Photocells
- D** Control card for operating during power outages
- F** Flashing light
- G** Antenna
- H** Control switch  
(Key – Code – Card or transponder fob)
- L** Control panel
- Q** Junction box
- X** Radio frequency card
- Z** Release device

**CABLES FOR STANDARD INSTALLATIONS**

LENGTH OF CABLE (m)	< 10	from 10 to 20	from 20 to 30
Power supply 230 V AC	3G x 1.5 mm <sup>2</sup>	3G x 1.5 mm <sup>2</sup>	3G x 2.5 mm <sup>2</sup>
Power supply 230 - 400 V AC three phase	4G x 1.5 mm <sup>2</sup>	4G x 1.5 mm <sup>2</sup>	4G x 2.5 mm <sup>2</sup>
Power supply to motor 230 V AC	3G x 1.5 mm <sup>2</sup>	3G x 1.5 mm <sup>2</sup>	3G x 2.5 mm <sup>2</sup>
Power supply to motor 230 - 400 V AC three phase	4G x 1.5 mm <sup>2</sup>	4G x 1.5 mm <sup>2</sup>	4G x 2.5 mm <sup>2</sup>
Power supply to motor 24 or 36 V DC	2G x 1.5 mm <sup>2</sup>	2G x 1.5 mm <sup>2</sup>	2G x 2.5 mm <sup>2</sup>
Limit switch micro-switches	*no. x 0.5 mm <sup>2</sup>	*no. x 0.5 mm <sup>2</sup>	*no. x 0.5 mm <sup>2</sup>
Flashing light 24 V AC - DC	2 x 1 mm <sup>2</sup>	2 x 1 mm <sup>2</sup>	2 x 1 mm <sup>2</sup>
Flashing light 230 V AC	2 x 1.5 mm <sup>2</sup>	2 x 1.5 mm <sup>2</sup>	2 x 1.5 mm <sup>2</sup>
TX Photocells	2 x 0.5 mm <sup>2</sup>	2 x 0.5 mm <sup>2</sup>	2 x 0.5 mm <sup>2</sup>
RX Photocells	4 x 0.5 mm <sup>2</sup>	4 x 0.5 mm <sup>2</sup>	4 x 0.5 mm <sup>2</sup>
Control devices	*no. x 0.5 mm <sup>2</sup>	*no. x 0.5 mm <sup>2</sup>	*no. x 0.5 mm <sup>2</sup>
Antenna		RG58 max 10 m	

\*no. = see product mounting instructions - Attention: the cable section is merely indicative as it depends on the motor power and cable length.

# SECTIONAL WITH DIRECT DRIVE



## COMPONENTS

- A** Gearmotor
- B** TX Photocells
- C** RX Photocells
- D** Control card for operating during power outages
- F** Flashing light
- G** Antenna
- H** Control switch  
(Key – Code – Card or transponder fob)
- L** Control panel
- Q** Junction box
- X** Radio frequency card
- Z** Release device

## CABLES FOR STANDARD INSTALLATIONS

LENGTH OF CABLE (m)	< 10	from 10 to 20	from 20 to 30
Power supply 230 V AC	3G x 1.5 mm <sup>2</sup>	3G x 1.5 mm <sup>2</sup>	3G x 2.5 mm <sup>2</sup>
Power supply 230 - 400 V AC three phase	4G x 1.5 mm <sup>2</sup>	4G x 1.5 mm <sup>2</sup>	4G x 2.5 mm <sup>2</sup>
Power supply to motor 230 V AC	3G x 1.5 mm <sup>2</sup>	3G x 1.5 mm <sup>2</sup>	3G x 2.5 mm <sup>2</sup>
Power supply to motor 230 - 400 V AC three phase	4G x 1.5 mm <sup>2</sup>	4G x 1.5 mm <sup>2</sup>	4G x 2.5 mm <sup>2</sup>
Power supply to motor 24 or 36 V DC	2G x 1.5 mm <sup>2</sup>	2G x 1.5 mm <sup>2</sup>	2G x 2.5 mm <sup>2</sup>
Limit switch micro-switches	*no. x 0.5 mm <sup>2</sup>	*no. x 0.5 mm <sup>2</sup>	*no. x 0.5 mm <sup>2</sup>
Flashing light 24 V AC - DC	2 x 1 mm <sup>2</sup>	2 x 1 mm <sup>2</sup>	2 x 1 mm <sup>2</sup>
Flashing light 230 V AC	2 x 1.5 mm <sup>2</sup>	2 x 1.5 mm <sup>2</sup>	2 x 1.5 mm <sup>2</sup>
TX Photocells	2 x 0.5 mm <sup>2</sup>	2 x 0.5 mm <sup>2</sup>	2 x 0.5 mm <sup>2</sup>
RX Photocells	4 x 0.5 mm <sup>2</sup>	4 x 0.5 mm <sup>2</sup>	4 x 0.5 mm <sup>2</sup>
Control devices	*no. x 0.5 mm <sup>2</sup>	*no. x 0.5 mm <sup>2</sup>	*no. x 0.5 mm <sup>2</sup>
Antenna		RG58 max 10 m	

\*no. = see product mounting instructions - Attention: the cable section is merely indicative as it depends on the motor power and cable length.

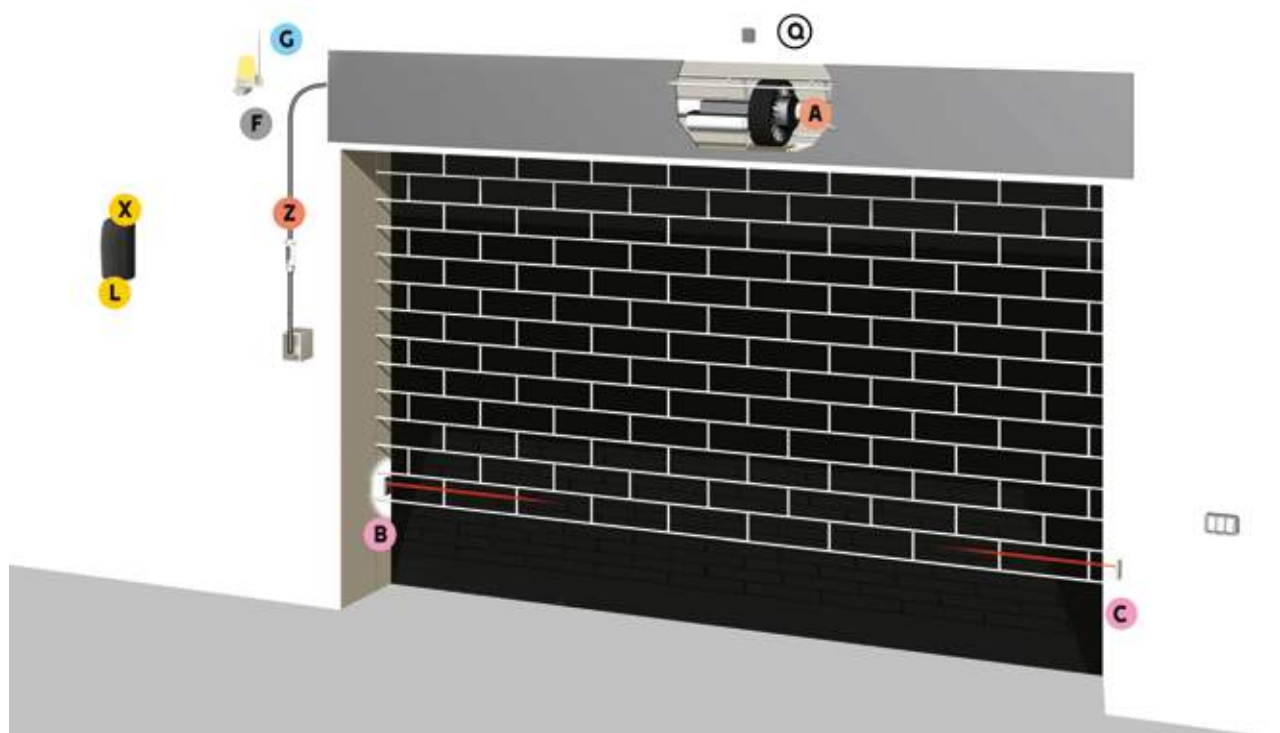

## COMPONENTS

- A** Gearmotor
- B** TX Photocells
- C** RX Photocells
- F** Flashing light
- G** Antenna
- L** Control panel
- Q** Junction box
- X** Radio frequency card
- Z** Release device

## CABLES FOR STANDARD INSTALLATIONS

LENGTH OF CABLE (m)	< 10	from 10 to 20	from 20 to 30
Power supply 230 V AC	3G x 1.5 mm <sup>2</sup>	3G x 1.5 mm <sup>2</sup>	3G x 2.5 mm <sup>2</sup>
Power supply to motor 230 V AC	3G x 1.5 mm <sup>2</sup>	3G x 1.5 mm <sup>2</sup>	3G x 2.5 mm <sup>2</sup>
Power supply to motor 24 or 36 V DC	2G x 1.5 mm <sup>2</sup>	2G x 1.5 mm <sup>2</sup>	2G x 2.5 mm <sup>2</sup>
Limit switch micro-switches	*no. x 0.5 mm <sup>2</sup>	*no. x 0.5 mm <sup>2</sup>	*no. x 0.5 mm <sup>2</sup>
Flashing light 24 V AC - DC	2 x 1 mm <sup>2</sup>	2 x 1 mm <sup>2</sup>	2 x 1 mm <sup>2</sup>
Flashing light 230 V AC	2 x 1.5 mm <sup>2</sup>	2 x 1.5 mm <sup>2</sup>	2 x 1.5 mm <sup>2</sup>
TX Photocells	2 x 0.5 mm <sup>2</sup>	2 x 0.5 mm <sup>2</sup>	2 x 0.5 mm <sup>2</sup>
RX Photocells	4 x 0.5 mm <sup>2</sup>	4 x 0.5 mm <sup>2</sup>	4 x 0.5 mm <sup>2</sup>
Electric Lock 12 V DC	2 x 1 mm <sup>2</sup>	2 x 1 mm <sup>2</sup>	2 x 1.5 mm <sup>2</sup>
Electric Lock 24 V DC	2 x 1 mm <sup>2</sup>	2 x 1 mm <sup>2</sup>	2 x 1 mm <sup>2</sup>
Control devices	*no. x 0.5 mm <sup>2</sup>	*no. x 0.5 mm <sup>2</sup>	*no. x 0.5 mm <sup>2</sup>
Antenna		RG58 max 10 m	

\*no. = see product mounting instructions - Attention: the cable section is merely indicative as it depends on the motor power and cable length.

# F4000

Industrial door automation



MAXIMUM LEAF LENGTH	MAXIMUM LEAF WEIGHT	USE
UP TO 2 m	UP TO 300 kg	INTENSIVE

## Ideal solution for fitting on swing-leaf and folding doors

- 24 V DC and 230 V AC EN versions tested thanks to the electronic management with encoder.
- Quick and simple installation.
- It can be installed either on the right or left thanks the symmetrical inputs on the gear shaft.
- Protection rating against weathering agents (IP54).
- In the 24 V DC versions it is possible to adjust the maneuvering speed, opening and closing slow-down speeds, and electronic detection of the obstacle.
- Developed with CONNECT technology for remote digital control via gateway or locally via CAME KEY.



## Dimensions (mm)

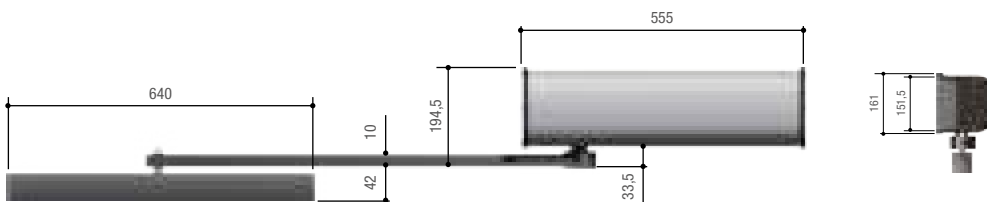

## Operational limits

MODEL	F40230E · F4024EP	F4024E
<b>SWING LEAF DOORS</b>		
Max. width of leaf (m)	2	1,5
Max. weight of leaf (kg)	300	200
<b>SINGLE-LEAF FOLDING DOORS</b>		
Max. width of leaf (m)	1,5	1,2
Max. weight of leaf (kg)	200	150

## Technical characteristics

MODELS	F40230E	F4024E	F4024EP
Protection rating (IP)	54	54	54
Power supply (V - 50/60 Hz)	230 AC	230 AC	230 AC
Power supply to motor (V)	230 AC 50/60 Hz	24 DC	24 DC
Absorption (A)	1,2	5 max	10 max
Power (W)	235	130	180
Crown turns (rpm)	1,3	1,3	24
Duty/cycle (%)	30	HEAVY-DUTY SERVICE	HEAVY-DUTY SERVICE
Thrust (N)	340	360	470
Operating temperature (°C)	-20 ÷ +55	-20 ÷ +55	-20 ÷ +55
Reduction ratio (i)	1/150	1/150	1/150
Motor's heat protection (°C)	150	-	-

● 230 V AC ● 24 V DC

## Code Description

### 230 V AC gearmotors tested in compliance with regulatory standards EN 12453

001**F40230E** Irreversible gearmotor with encoder.



### Control panels for 230 V AC gearmotors, tested in compliance with regulatory standards EN 12453

002**ZM3E** Multifunction control panel for swing gates with two leaves, graphic programming and alerts display, plus self-diagnosing safety devices and on-board radio decoding.



002**ZM3EC** Multifunction control panel for two-leaved doors, complete with safety lock and buttons, with graphic programming display and signalling, plus self-diagnosing safety devices.



### 24 V DC gearmotors, tested in compliance with regulatory standards EN 12453

001**F4024E** Irreversible gearmotor with encoder.



001**F4024EP** Irreversible gearmotor with encoder – boosted version.



### Control panels for 24 V gearmotors, tested in compliance with regulatory standards EN 12453

**801QA-0050** ZLX24MA - Multifunctional control panel, with 230 V AC power supply, for 24 V double-leaf gates, with programming and signaling display, self-diagnosis of safety devices, Adaptive Speed & Torque Technology, CXN BUS, 2 safety inputs and storage for up to 250 users.



**801QA-0060** ZLX24SA - Multifunctional control panel, with 230 V AC power supply, for 24 V double-leaf gates, with programming and graphical signaling display, self-diagnosis of safety devices, Adaptive Speed & Torque Technology, CXN BUS, 4 safety inputs and storage for up to 1000 users.



### Accessori per: 801QA-0050 - 801QA-0060

002**RLB** Circuit board for emergency operation and battery charging.



### CXN BUS interface for: 801QA-0050 - 801QA-0060

**806XG-0080** BUS expansion module with 2 inputs and 2 outputs. Inputs can be configured in NO, NC or resistive mode (8K2), a warning light output and a relay output.



### Accessories

001**F4004** Sliding drive-arm with track.



001**CMS** Release handle with customized key and resetting pull-cord L = 7 m.



001**C002** Hanging release system.



MAX. LEAF HEIGHT	SHAFT Ø	USE
UP TO 11 m	25.4 mm (1")	20 CYCLES/HOUR



## Ideal solution for sectional, sliding or folding door applications

- C-BXK offers more torque for moving very heavy doors at 230 V AC .
- It can open manually by using the handy winch device.
- Possibility of horizontal and vertical installation for greater versatility.
- 230 - 400 V AC three-phase version, equipped with encoder, to guarantee greater thrust and maximum safety.

### Dimensions (mm)

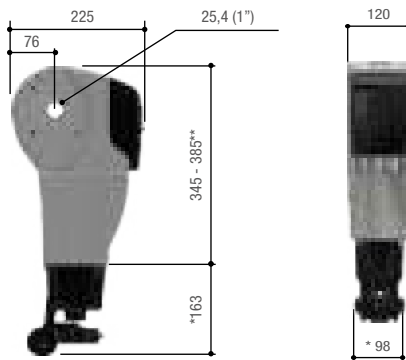

\* Accessory  
\*\* 001C-BXK

### Operational limits

MODELS	C-BX	C-BXK	C-BXT
<b>DIRECTLY-DRIVEN SECTIONAL DOORS</b>			
Max. height of leaf (m)	5,5	5,5	5,5
<b>CHAIN-DRIVEN SECTIONAL DOORS</b>			
Max. height of leaf (m)	8,5	8,5	8,5
<b>SLIDING AND FOLDING SLIDING DOORS</b>			
Max. height of leaf (m)	11	11	11

### Technical characteristics

MODELS	C-BX	C-BXK	C-BXT
Protection rating (IP)	54	54	54
Power supply (V - 50/60 Hz)	230 AC	230 AC	230-400 V AC THREE PHASE
Power supply to motor (V)	230 AC 50/60 Hz	230 AC 50/60 Hz	230-400 V AC TRIPH. 50/60Hz
Absorption (A)	2,2	3,6	2,5
Power (W)	450	750	750
Crown turns (rpm)	21,5	21,5	21,5
Duty/cycle (%)	30	30	50
Thrust (N)	60	120	80
Operating temperature (°C)	-20 ÷ +55	-20 ÷ +55	-20 ÷ +55
Motor's heat protection (°C)	150	150	150

● 230 V AC ● 230 – 400 V AC THREE PHASE

Code	Description
<b>230 V AC Gearmotors</b>	
001 <b>C-BX</b>	Gearmotor with mechanical limit-switches.
001 <b>C-BXK</b>	Gearmotor with mechanical limit-switches.
<b>Control panels for gearmotors: 001 C-BX – 001 C-BXK</b>	
<b>801QA-0140</b>	230 V control panel for industrial doors with brake function.
<b>801QA-0150</b>	230 V control panel for industrial doors, with brake function and complete with safety lock and push buttons.
002 <b>ZM3EC</b> 	Multifunction control panel for two-leaved doors, complete with safety lock and buttons, with graphic programming display and signalling, plus self-diagnosing safety devices.



# THE COMPLETE RANGE

## Code Description

### 230 - 400 V AC three-phase gearmotors

001**C-BXT** Gearmotor with mechanical limit-switches.



### Control panels for gearmotor: 001C-BXT

002**ZT6N** Control panel with self-diagnosis of safety devices, configurable C1, CX resistive inputs, external soft start management, maximum number of users: 25.



002**ZT6NC** Control panel complete with safety lock and buttons with self-diagnosis of safety devices, configurable C1, CX resistive inputs, external soft start management, maximum number of users: 25.



Code	Description
<b>Accessories for: SLIDING AND SWING-LEAF DOORS</b>	
009 <b>CCT</b>	Simple 1/2" chain.
009 <b>CGIU</b>	Joint for 1/2" chain.
001 <b>C003</b>	Reset system for sliding doors with Z = 26 pinion shaft for gearmotor hollow shaft, chain-tightening reset, gearmotor-anchoring braces and lead-fastening braces.
001 <b>C004</b>	Reset system for folding doors with Z = 26 pinion shaft for gearmotor hollow shaft, chain-tightening reset, gearmotor-anchoring braces and lead-fastening braces.
<b>Accessories for: SECTIONAL DOORS</b>	
001 <b>C011</b>	Chain transmission system with 1:1 ratio, featuring a pinion with Z = 26 for gearmotor hollow shaft, Z = 26 pinion with chain and coupler for 1/2" chain and bracers for anchoring to the gearmotor.
001 <b>C005</b>	Chain-drive system (upper door height at 5.5.m) with Z = 26 pinion shaft for gearmotor hollow shaft, Z = 40 pinion with chain and joint for 1/2" chain and gearmotor-anchoring braces.
001 <b>C006</b>	Package of two drilled braces with Ø 25.4 mm (1") spring shaft (this accessory is specific for fitting onto doors with direct transmission gearmotor).
001 <b>C007</b>	Accessory with Ø 25 mm spring shaft.
001 <b>C008</b>	Accessory with Ø 40 mm spring shaft.
001 <b>C009</b>	Motor supporting brace with Ø 25.4 mm (1") spring shaft (specific accessory for fitting onto doors with direct-drive gearmotors).
<b>801XC-0150</b>	Winch for manual drive with DIN 766 Ø 3 mm chain (chain L = 10 m).
<b>Accessories</b>	
001 <b>CMS</b>	Release handle with customized key and resetting pull-cord L = 7 m.
001 <b>C002</b>	Hanging release system.
<b>24 V accessories for: SECTIONAL DOORS</b>	
<b>806XG-0060</b> 	Safety sensor for industrial doors using laser technology with a detection zone of max. 10 m × 10 m.
<b>806XG-0070</b> 	Safety sensor for industrial doors using laser technology with a detection zone of max. 5 m × 5 m.
<b>Accessories for: 806XG-0060 - 806XG-0070</b>	
<b>818XG-0019</b>	Remote control for opening and safety detector.
<b>806XG-0050</b>	Steel support for opening detector and barrier safety.
<b>806XG-0040</b>	24 V DC power supply for opening and safety detector.



## Ideal for winding shutters in single homes and apartment blocks

- Operator for most private and business facilities.
- Adaptable to either 48 mm or 60 mm shutter shafts and 200 mm or 220 mm springs.
- Quick and easy travel adjusting.
- Series adaptors for all models.
- Reduction ratio: 1: 150.



### Dimensions (mm)

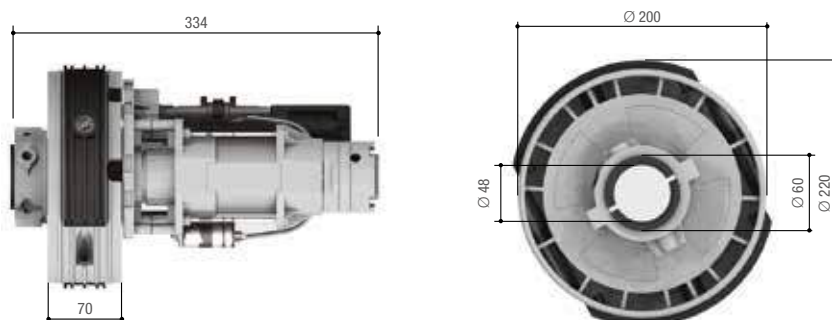

### Operational limits

MODELS	001H40230120	001H41230120	001H40230180	001H41230180
Max. hoisting strength (kg)	120	120	180	180

### Technical characteristics

CODE	001H40230120	001H41230120	001H40230180	001H41230180
Hoisted weight (Kg)*	120	120	180	180
Protection rating (IP)	40	40	40	40
Power supply (V - 50/60 Hz)	230 AC	230 AC	230 AC	230 AC
Absorption (A)	1,95	1,95	2,6	2,6
Power (W)	450	450	600	600
Reduction ratio (i)	1/150	1/150	1/150	1/150
Duty/cycle (%)	30	30	30	30
Crown turns (rpm)	10	10	10	10
Operating temperature (°C)	-20 ÷ +55	-20 ÷ +55	-20 ÷ +55	-20 ÷ +55
Motor's heat protection (°C)	160	160	160	160

Code	Description
<b>230 V AC Gearmotors</b>	
001 <b>H40230120</b>	230 V AC irreversible operator complete with pull-cord release. Max. lifted weight 120 kg.
001 <b>H41230120</b>	230 V AC reversible operator Max. lifted weight 120 kg.
001 <b>H40230180</b>	230 V AC irreversible operator complete with pull-cord release. Max. lifted weight 180 kg.
001 <b>H41230180</b>	230 V AC reversible operator Max. lifted weight 180 kg.
<b>Control panels for 230 V AC gearmotors</b>	
<b>809QA-0010</b>	230 V AC control panel with on-board radio decoding.
<b>Accessories for: 001H41230120 - 001H41230180</b>	
001 <b>H001</b>	Electric lock for the H41230120 and H41230180 reversible gearmotors, with pull-cord measuring L = 5 m and releasing knob.
<b>Accessories for: 001H40230120 - 001H40230180</b>	
001 <b>H3001</b>	Safety casing with release knob and control button for pull-cord releasing.



# CONTROL PANEL DIMENSIONS

## Dimensions (mm)

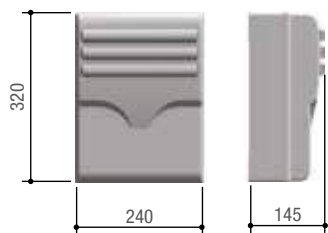

002ZM3E  
002ZC3  
002ZC3C  
002ZM3EC

002ZT6N  
002ZT6NC

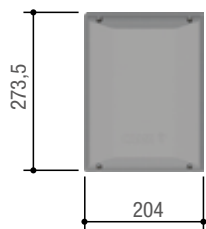

801QA-0050

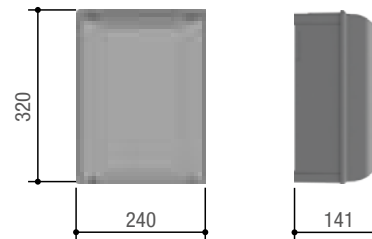

801QA-0060

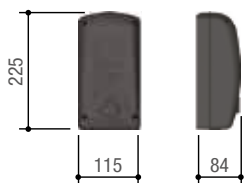

002ZM3E  
002ZC3  
002ZC3C  
002ZM3EC

The table shows all of the characteristics of the industrial entrances control-panels.

Models / Series	F40230E	F40230E C-BX C-BXK	F4024E F4024EP	F4024E F4024EP	C-BX C-BXK	C-BX C-BXK	C-BXT	C-BXT	H4
Control board / Control panel	ZM3E	ZM3EC	801QA-0050	801QA-0060	ZC3	ZC3C	ZT6N	ZT6NC	809QA-0010
<b>Safety</b>									
SELF-DIAGNOSING safety decives	●	●	●	●	●	●	●	●	●
PRE-FLASHING when opening and closing	●	●	●	●	●	●	●	●	
REOPENING during closing	●	●	●	●	●	●	●	●	●
CLOSING AGAIN during opening	●	●	●	●	●	●	●	●	
Obstruction WAIT	●	●	●	●					
TOTAL STOP	●	●	●	●	●	●	●	●	●
PARTIAL STOP	●	●	●	●	●	●	●	●	
OBSTRUCTION DETECTION in front of photocells	●	●	●	●	●	●	●	●	
ENCODER	●	●							
MOVEMENT CONTROLLING and OBSTRUCTION DETECTING device.	●		●	●					
AMPEROMETRIC DETECTION			●	●					
<b>Command</b>									
PEDESTRIAN OPENING 1 leaf	●	●	●	●					
PARTIAL OPENING 1 leaf	●	●	●	●	●	●	●	●	
OPEN ONLY from transmitter and/or from button	●	●	●	●	●	●	●	●	
ONLY OPEN or ONLY CLOSE button connection	●	●	●	●	●	●	●	●	
OPEN-STOP-CLOSE-STOP from the transmitter and/or button	●	●	●	●	●	●	●	●	●
OPEN-CLOSE-INVERT from the transmitter and/or button	●	●	●	●	●	●	●	●	●
MAINTAINED ACTION	●	●	●	●	●	●	●	●	●
DELAYED OPENING 1st leaf	●	●	●	●					
DELAYED OPENING 2nd leaf	●	●	●	●					
IMMEDIATE CLOSING									
EMERGENCY RELEASE from the transmitter									
<b>Characteristics</b>									
FLASHING LIGHT connection	●	●	●	●	●	●	●	●	●
CYCLE LIGHT connection	●	●	●	●	●	●	●	●	
COURTESY LIGHT connection	●	●	●	●	●	●	●	●	●
Antenna	●	●	●	●	●	●	●	●	●
OPEN ALERT LIGHT connection	●	●	●	●	●	●	●	●	
CLOSED ALERT LIGHT connection			●	●			●	●	
Contact output for 2nd RADIO CHANNEL	●	●		●	●	●	●	●	
SELF-LEARNING of the transmitter's RADIO CODE	●	●	●	●	●	●	●	●	●
OPERATING TIME adjusting	●	●	●		●	●			●
Connection for the ELECTRIC LOCK and/or RAMMING	●	●	●	●					
SLEEP MODE	●								
Adjustable AUTOMATIC CLOSING AGAIN TIME	●	●	●	●	●	●	●	●	●
OPENING and/or CLOSING slow downs	●	●	●	●					
EMERGENCY BATTERY operation (optional)			●	●					
MASTER-SLAVE							●	●	
Adjustable TRAVEL and SLOW-DOWN speeds*	●	●	●	●					
DISPLAY	●	●	●						
Electronic brake					●	●	●	●	
SELF-LEARNING opening and closing limit-switches	●	●	●	●					
CAME Connect	●		●	●					
CRP control	●		●	●					
CXN BUS			●	●					
AST (Adaptive Speed and Torque Technology)			●	●					
Slot CAME KEY			●	●					
TIMER control				●					
Possibility of managing two different motors				●					

● 230 V AC ● 24 V DC ● 230 – 400 V AC THREE PHASE

Note

\* 002 ZM3E - 002ZM3EC only for slow-down speed

# CONTROL AND SAFETY ACCESSORIES

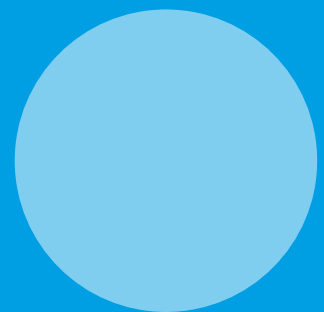
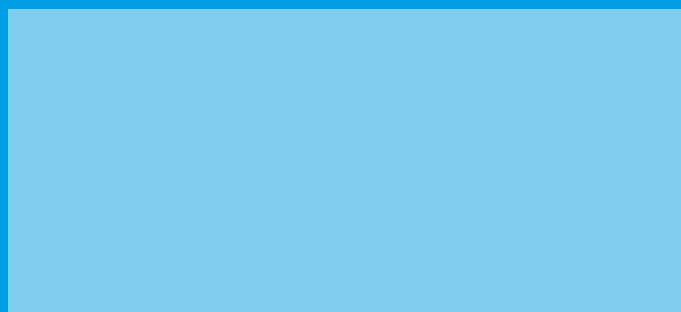
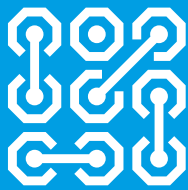







202	SELECTION GUIDE
212	TTS
214	TOP
218	DXR
220	DLX
222	DIR
224	KLT
226	KRX
228	KIARO
230	SEL KEY
232	SEL DIGITAL
236	RBE-RE
240	GATEWAY
242	DFWN
244	EDG
248	RIO SYSTEM 2.0
250	QUICK&EASY ACCESS

# Selection guide

## CONTROL AND SAFETY ACCESSORIES

The control and safety accessories complete and optimize the system and ensure its efficiency and peace-of-mind of the user, in full compliance with European Standards. The following pages are laid out to simplify your choosing of accessories that best suit your system.

### SAFETY ACCESSORIES





Product	Series	Characteristic	Type	Code	
Photocells	DIR	Surface mounted	Synchronized infrared	001DIR10	
		Surface mounted	Synchronized infrared	001DIR20	
		Surface mounted	Synchronized infrared	001DIR30	
	DXR	Surface mounted	Synchronized infrared	806TF-0030	
		Surface mounted	Synchronized infrared	806TF-0040	
		Surface mounted	Synchronized infrared	806TF-0120	
	Surface mounted	Battery-operated synchronized infrared	806TF-0060		
	Surface mounted	Synchronized infrared with CXN BUS connection	806TF-0110		
	Surface mounted	Synchronized infrared with CXN BUS connection	806TF-0110		
	DLX	Recess mounted	Synchronized infrared	806TF-0070	
		Surface mounted	Synchronized infrared	806TF-0080	
	Recess mounted	Synchronized infrared with CXN BUS connection	806TF-0090		
	Surface mounted	Synchronized infrared with CXN BUS connection	806TF-0100		
Wireless safety systems	RIO System 2.0	Surface mounted	Radio control module	806SS-0050	
		Surface mounted	Wireless flashing light	806SS-0030	
		Surface mounted	Wireless infrared beam photocells	806SS-0010	
		Surface mounted	Wireless module for sensitive safety-edges.	806SS-0020	

## SAFETY ACCESSORIES







Product	Series	Characteristic	Type	Code	
Sensitive safety-edges	EDG H	Resistive	Ready to use L = 1500 mm	806ED-0130	
		Resistive	Ready to use L = 1700 mm	806ED-0131	
		Resistive	Ready to use L = 2000 mm	806ED-0132	
		Resistive	Ready to use L = 2500 mm	806ED-0133	
	EDG I	Resistive	Ready to use L = 1500 mm	806ED-0140	
		Resistive	Ready to use L = 1700 mm	806ED-0141	
		Resistive	Ready to use L = 2000 mm	806ED-0142	
		Resistive	Ready to use L = 2500 mm	806ED-0143	
	EDG L	Resistive	Ready to use L = 1500 mm	806ED-0150	
		Resistive	Ready to use L = 1700 mm	806ED-0151	
		Resistive	Ready to use L = 2000 mm	806ED-0152	
		Resistive	Ready to use L = 2500 mm	806ED-0153	
	DFWN	Mechanical	Ready to use	001DFWN1500 001DFWN1500N	
		Mechanical	Ready to use	001DFWN1700 001DFWN1700N	
		Mechanical	Ready to use	001DFWN2000 001DFWN2000N	
		Mechanical	Ready to use	001DFWN2500 001DFWN2500N	
Flashing lights	KIARO	Optional antenna	LED	001KLED	
		Optional antenna	LED	001KLED24	
	KRX	Built-in antenna	LED	806LA-0010	
		Built-in antenna	LED	806LA-0020	
		Built-in antenna	LED	806LA-0030	
		Built-in antenna	LED with BUS CXN connection	806LA-0050	
	KLT	Built-in antenna	LED with BUS CXN CONNECT connection	806LA-0070	
		Built-in antenna	LED	806LA-0060	

For all sensitive safety edges, individual items are available for tailor-made composition.

## CONTROL ACCESSORIES

Product	Series	Characteristic	Type	Code	
Selectors	SEL Digital	Surface mounted	Bluetooth digital Standalone	806SL-0340	
		Surface mounted	Bluetooth digital Standalone	806SL-0350	
		Surface mounted	Bluetooth digital Standalone	806SL-0360	
		Surface mounted	Plug-in digital bluetooth	806SA-0140	
		Surface mounted	Digital transponder with BUS CXN connection	806SL-0300	
		Recess mounted	Digital transponder with BUS CXN connection	806SL-0310	
		Surface mounted	Digital transponder MiFare with BUS CXN connection	806SL-0320	
		Recess mounted	Digital transponder MiFare with BUS CXN connection	806SL-0330	
		Surface mounted	Digital with wireless keypad	806SL-0170	
		Surface mounted	Digital with wireless keypad	806SL-0180	
		Surface mounted	Digital with BUS CXN connection keypad	806SL-0280	
		Recess mounted	Digital with BUS CXN connection keypad	806SL-0290	
		Recess mounted	Microwave sensor	806SL-0260	
		Indoor	Magnetic sensor	001SMA	
Indoor	Magnetic sensor	001SMA2			
Indoor	Magnetic sensor	001SMA220			
SEL Key	SEL Key	Surface mounted	Key-operated with DIN cylinder	806SL-0050	
		Surface mounted	Key-operated with DIN cylinder CXN BUS	806SL-0070	
		Surface mounted	Key-operated with DIN cylinder For 230 V	806SL-0090	
		Recess mounted	Key-operated with DIN cylinder	806SL-0060	
		Recess mounted	Key-operated with DIN cylinder CXN BUS	806SL-0080	
		Recess mounted	Key-operated with DIN cylinder For 230 V	806SL-0100	
		Surface mounted	Key-operated with cylinder	806SL-0010	
		Surface mounted	Key-operated with cylinder CXN BUS	806SL-0030	
		Recess mounted	Key-operated with cylinder	806SL-0020	
		Recess mounted	Key-operated with cylinder CXN BUS	806SL-0040	
		Surface mounted	Key-operated without DIN cylinder	806SL-0051	
		Recess mounted	Key-operated without DIN cylinder	806SL-0061	

## CONTROL ACCESSORIES

Product	Series	Characteristic	Type	Code	
Transmitters	TOP	433,92 MHz Rolling code	4 buttons	806TS-0270	
		433,92 MHz Fixed Code	2 buttons	806TS-0300	
		433,92 MHz Fixed Code	4 buttons	806TS-0310	
		433,92 MHz - 868,35 MHz Rolling code	4 buttons	806TS-0290	
		433,92 MHz - 868,35 MHz Fixed code	4 buttons	806TS-0330	
	TTS	433,92 MHz - 868,35 MHz Rolling code	4 buttons	806TS-0230	
		433,92 MHz Fixed Code	4 buttons	806TS-0240	
		433,92 MHz Rolling Code	4 buttons	806TS-0250	



## Characteristics

SERIES	MODEL	FREQUENCY	FREQUENCY	MODE	MODE
		433.92 MHz	868.35 MHz	FIXED CODE	ROLLING CODE
<b>SEL Digital</b>	806SL-0170	●		●	●
	806SL-0180		●	●	●
<b>TTS</b>	806TS-0230	●	●		●
	806TS-0240	●		●	
	806TS-0250	●			●
	806TS-0270	●			●
<b>TOP</b>	806TS-0300	●		●	
	806TS-0310	●		●	
	806TS-0290	●	●		●
	806TS-0330	●	●	●	



## KLT FOR BARRIERS

KLT is the perfect solution for applications on GARD LT4 and GARD LS4 automatic barriers. The simple connection and the possibility of customizing colors and flashing type, allow the installer to choose the best signaling configuration for each specific context.

## Selectors - interface cards combinations

SERIES	MODEL	CONTROL PANEL TYPE		EXTERNAL INTERFACE CARD	RECEIVER MODULES*	
		CONTROL PANEL WITHOUT CXN BUS*	CONTROL PANEL WITH CXN BUS	806SL-0370	806RV-0010	806RV-0020
		Plug-in interface cards			Plug-in interface cards	
SEL Digital	806SL-0280	001R800**	●	●	001R800**	
	806SL-0290		●	●		
	806SL-0300		●	●		
	806SL-0310	001R700**	●	●	001R700**	
	806SL-0320		●	●		
	806SL-0330		●	●		

Notes  
 \* Interface card to be purchased depending on control panel type  
 \*\* If provided in the control panel, otherwise use 806SL-0370.

## Radio devices - receivers combinations

SERIES	MODEL	CONTROL PANEL TYPE		RECEIVER TYPE		RECEIVER MODULES *	
		CONTROL PANEL WITH DISPLAY *	CONTROL PANEL WITHOUT DISPLAY *	TWO-CHANNEL RECEIVER		806RV-0010	806RV-0020
		Plug-in radio-frequency board		001RE432M	001RE862M	Plug-in radio-frequency board	
SEL Digital	806SL-0170	001AF43S		●		001AF43S	
	806SL-0180	001AF868			●	001AF868	
TTS	806TS-0230	001AF43S or 001AF868	001AF43SR or 001AF868SR	●	●	001AF43S or 001AF868	
	806TS-0240	001AF43S	001AF43TW	●		001AF43S	
	806TS-0250		001AF43SR	●			
TOP	806TS-0270	001AF43S	001AF43SR	●		001AF43S	
	806TS-0300		001AF43TW (Key Code)	●			
	806TS-0310		001AF43TW (Key Code)	●			
	806TS-0290		001AF43SR or 001AF868SR	●	●		
	806TS-0330	001AF43S or 001AF868 (Default)	001AF43TW (433 MHz only)	●	●	001AF43S or 001AF868	

Note  
 \* Decoder control card to buy depending on the type of control panel  
 \*\* Se prevista codifica nel quadro comando, altrimenti utilizzare 806SL-0370.



## KLT FOR GARAGE DOORS

KLT is the perfect solution for any setting where the application of a slim flashing light with essential lines is required.

Installed on a wall or post, KLT is a safety indicator in case of moving automations for garage doors, industrial doors or gates.

# THE SAFETY

## GENERAL CHARACTERISTICS



### **PHOTOCELLS: SYNCHRONIZED INFRARED BEAM**

Thanks to the synchronized beam, multiple pairs of photocells can be applied to the same system, even at double height and/or close to each other - with no interference issues.



### **FLASHING LIGHTS: LOW CONSUMPTION MOVEMENT DETECTORS**

Lightweight, practical and quick to install, the beacons are equipped with a low consumption LED lamp.

Available in 24 V AC - DC and 120 - 230 V AC versions, they are equipped with accessories for wall mounting and integrated antenna (KRX and KLT).



### **SENSITIVE SAFETY EDGES: CUSTOMIZABLE AND READY TO INSTALL**

Equipped with a resistive contact and certified in accordance with EN13849-1 standards, they are used to create automation systems with high safety standard.



### **WIRED AND REMOTE CONTROLS: SAFETY AND VERSATILITY**

When installed with sensitive edges, they control the protections installed on both the moving leaf gate and the fixed part, with a high level of safety in full compliance with current regulations.



## The photocells with aluminium cover

The DXR series of swivel photocells can also be used to control a system thanks to the adjustable relay output. Special aluminium covers are also available, specific for applications where maximum strength and reliability are required.

## GENERAL CHARACTERISTICS



### SELF-LEARNING OF THE CODE FROM TRANSMITTER TO RECEIVER

This function lets the dedicated receiver memorize the code assigned to the transmitter.



### SELF-LEARNING OF THE CODE FROM TRANSMITTER TO TRANSMITTER

This characteristic lets you create a duplicate transmitter, by copying the code onto another identical device.



### MULTI-USER CODES

This characteristic on the transmitter is for emitting different codes for each key on the transmitter itself.

The aim is to obtain control of independent systems that are located within the same operating range.

(E.g.: common gate used by all tenants and private overhead garage door for each tenant).



### RADIO SYSTEM CERTIFICATION

All CAME radio-frequency systems are certified for using in European and non-European countries.



## MADE IN ITALY, made by CAME!

The 100% Made-in-Italy brand of origin certifies that all CAME products come from a quality manufacturing process, designed to provide reliable and effective technological products. The products have been tested for 10 to 15 years of wear and tear under intense activity, with extreme temperature resistance tests and specific checks on operating in electromagnetic interference conditions.

## RIO SYSTEM 2.0, COMPLETELY SAFE, NO WIRES

RIO System 2.0 is the innovative radio-based safety system that needs no wired connection between the control module and the safety accessories. This feature drastically reduces installation times. Control module, photocells, sensitive safety-edge and flashing light all make up a complete system based on totally wireless transceiver-technology. This is ideal for bringing up to code any existing systems or for rapidly installing entirely new systems. The control module is to be connected to the operator's control panel, whereas the other modules interact via radio.

RIO System 2.0 is incompatible with the previous version.

### SYSTEM COMPONENTS AND MAIN CHARACTERISTICS

#### 806SS-0050



- Radio control module, with 30 m range, which can manage up to 6 Rio series wireless accessories that are programmed during installation.
- LED for monitoring the system and devices' operation.
- Buzzer for flat-battery or wireless accessory malfunction alerts.
- Automatic frequency switching when radio-frequency disturbances occur.
- Special function for viewing radio-signal quality and any disturbances.

#### 806SS-0030



- Wireless, battery-operated flashing light.
- Two high-luminosity LEDs to provide 360° alerts when the operator is moving.
- LED for monitoring the system and devices' operation.

#### 806SS-0020



- Certified product, validated for category 2, which means it is highly safe and reliable.
- Wireless module for controlling one or two resistive sensitive safety-edges of the 8k2 DFWN series, that can transmit and receive from and to Rio control.
- Battery powered.
- LED for monitoring the system and devices' operation.
- Buzzer for flat-battery alerts or poor radio communication.

#### 806SS-0010



- Pair of battery-powered wireless photocells that can transmit and receive to and from the 806SS-0040 and 806SS-0050 modules.
- Infrared signal (range 10 m).
- LED for monitoring the system and devices' operation.
- Buzzer for flat-battery alerts or poor radio communication.

#### 806SS-0040



- Snap-in radio control module for controlling wireless accessories to use in corresponding automated operators.

## EXAMPLE FITTED ONTO SLIDING GATE

- A** = Trasmitter 806SS-0010.
- B** = Receiver 806SS-0010.
- C** = Receiver 806SS-0020.
- D** = Sensitive safety edge of the DFWN series.
- E** = Flashing light 806SS-0030.
- F** = Control modules 806SS-0050 and 806SS-0040

### INSTALLATION ACCESSORIES:

#### FOR RIO SYSTEM 2.0-SERIES PHOTOCELLS

- 001DB-L Post made of natural-finish anodized aluminum.
- 001DB-LN Post made of black anodized aluminum. H = 500 mm.
- 001DB-CG RAL9006 silver PVC post. H = 500 mm.

#### FOR RIO System 2.0 FLASHING LIGHT

- 001KIAROS Base for wall-mounting.

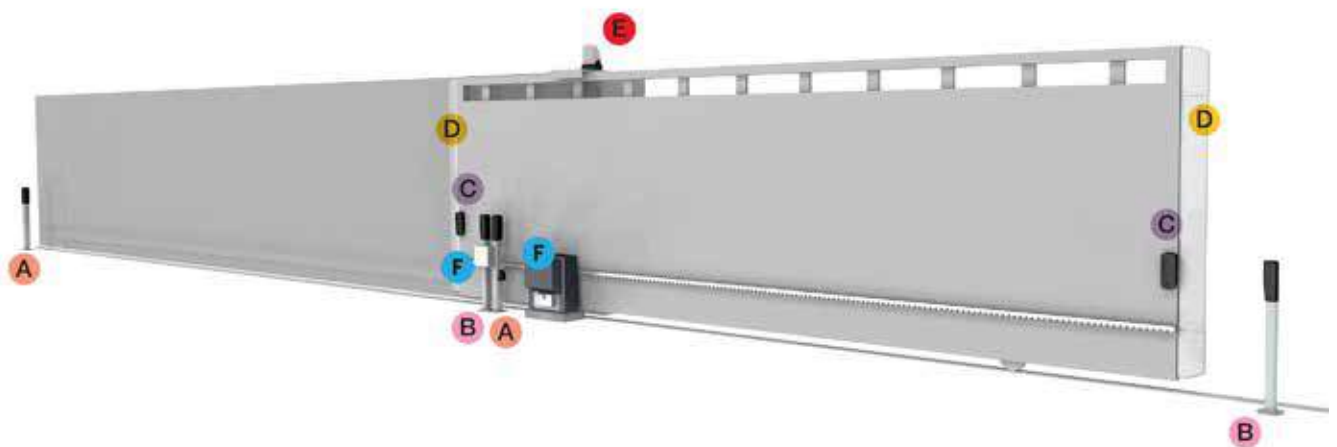

## Remote control featured by an elegant and refined design



- Available in rolling code and fixed code versions.
- Self-learning from transmitter to transmitter.
- Self-learning from TOP, TAM and TWIN series radio controls.
- Removable battery compartment for easy replacement.
- Multi-user function for fixed code version.
- More secure thanks to the dynamic code for the rolling code version.
- It can be configured remotely via gateway or locally via CAME KEY.

### Dimensions (mm)

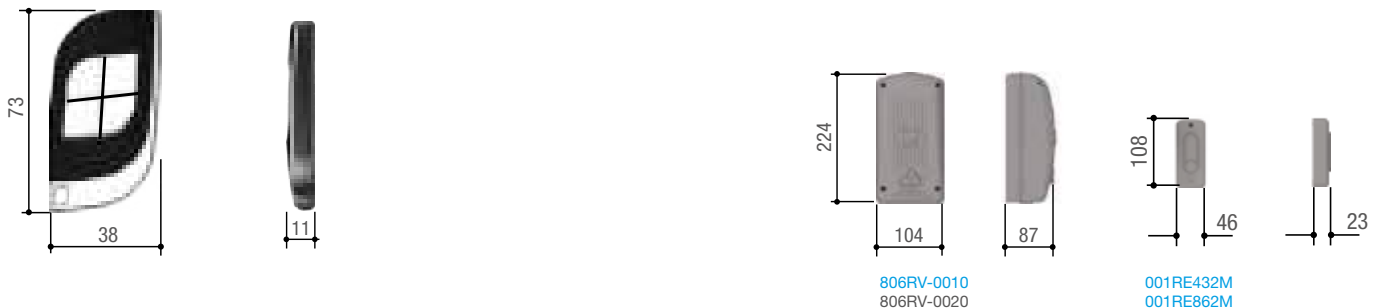

### Operational limits

MODELS	806TS-0230	806TS-0240	806TS-0250
Max. range of radio (m)	50 ÷ 150	50 ÷ 150	50 ÷ 150

### Technical characteristics

MODELS	806TS-0230	806TS-0240	806TS-0250
Combinations	4.294.967.896	16.777.216	4.294.967.896
Radio signal frequency (Mhz)	433,92 - 868,35	-	433,92
Battery type	1 CR2032 Lithium	1 CR2032 Lithium	1 CR2032 Lithium
Operating temperature (°C)	-20 ÷ +55	-20 ÷ +55	-20 ÷ +55
Material	Polycarbonate - Zamak	Polycarbonate - Zamak	Polycarbonate - Zamak

## Code Description

Code	Description
<b>Dual frequency transmitters, 433.92 MHz and 868.35 MHz</b>	
<b>806TS-0230</b>	TTS4RKS - Double frequency four-channel rolling code transmitter. 4,294,967,896 combinations.
<b>433.92 MHz transmitters</b>	
<b>806TS-0240</b>	TTS44FKS - Four-channel transmitter with new fixed code encoding at 433.92 MHz and self-learning function for TOP, TAM and TWIN series radio controls.
<b>806TS-0250</b>	TTS44RKS - Four-channel 433.92 MHz rolling code transmitter. 4,294,967,896 combinations.
<b>Snap-in 433.92 MHz receivers</b>	
001 <b>AF43S</b>	433,92 MHz plug-in radio frequency card.
001 <b>AF43SR</b>	433.92 MHz plug-in radio frequency card for maximum 25 Rolling Code transmitters.
001 <b>AF43TW</b>	433,92 MHz plug-in radio frequency card.
<b>868.35 MHz plug-in receivers for: 806TS-0230</b>	
001 <b>AF868</b>	868.35 MHz plug-in radio frequency card.
001 <b>AF868R</b>	868.35 MHz plug-in radio frequency card for maximum 25 Rolling Code transmitters.
<b>24 V AC - DC external modules</b>	
<b>806RV-0010</b> 	RBE4024 - Four-channel surface-mounted multi-user IP54 receiver module, 24 V AC - DC to store up to 3000 different users (codes), for TOP, TAM, ATOMO D, TWIN and TTS coding.
<b>120 - 230 V AC external modules</b>	
<b>806RV-0020</b> 	RBE4230 - Four-channel surface-mounted multi-user IP54 receiver module, 120 - 230 V AC to store up to 3000 different users (codes), for TOP, TAM, ATOMO D, TWIN and TTS coding.
<b>External, 12 - 24 V AC - DC, 433.92 MHz radio receivers</b>	
001 <b>RE432M</b> 	Two-channel 433.92 MHz surface-mounted IP54 12 - 24 V AC - DC receiver for storing up to 50 different users (codes), with TOP, TAM, ATOMO D, TWIN and TTS coding.
<b>External, 12 - 24 V AC - DC, 868.35 MHz radio receivers for: 806TS-0230</b>	
001 <b>RE862M</b> 	Two-channel 868.35 MHz surface-mounted IP54 12 - 24 V AC - DC receiver for storing up to 50 different users (codes), with TOP, TAM, ATOMO D and TTS coding.
<b>868.35 MHz antenna for: 001KLED – 001KLED24</b>	
001 <b>TOP-A862N</b>	Antenna tuned at 868.35 MHz.
<b>433.92 MHz antenna for: 001KLED – 001KLED24</b>	
001 <b>TOP-A433N</b>	Antenna tuned at 433.92 MHz.
<b>Accessories</b>	
001 <b>TOP-RG58</b>	Antenna cable L = 5 m.
<b>Transmitter accessories</b>	
<b>806XG-0020</b>	Pack of no. 2 3V DC CR2032 lithium batteries.



NOTES: for the 806RV-0010 and the 806RV-0020 use the 001AF43S or the 001AF868.



**The CAME remote control, available in rolling code and fixed code versions**

- Available in rolling code and fixed code versions.
- Self-learning from transmitter to transmitter.
- Self-learning from TOP, TAM and TWIN series radio controls.
- Frequency change function for dual frequency versions.
- Multi-user function for fixed code version.
- More secure thanks to the dynamic code for the rolling code version.
- It can be configured remotely via gateway or locally via CAME KEY.

**Dimensions (mm)**

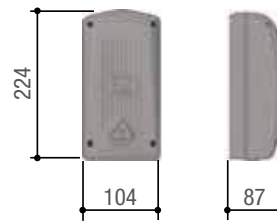
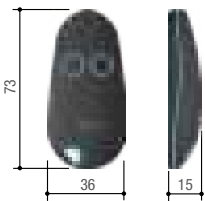

806RV-0010  
806RV-0020

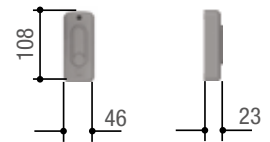

001RE432M  
001RE862M

**Operational limits**

MODELS	806TS-0270	806TS-0300	806TS-0310	806TS-0290	806TS-0330
Max. range of radio (m)	50 ÷ 150	50 ÷ 150	50 ÷ 150	50 ÷ 150	50 ÷ 150

**Technical characteristics**

MODELS	806TS-0270	806TS-0300	806TS-0310	806TS-0290	806TS-0330
Combinations	4.294.967.896	-	-	4.294.967.896	-
Radio signal frequency (Mhz)	433,92	433,92	433,92	433,92 - 868,35	433,92 - 868,35
Battery type	1 CR2032 Lithium	1 CR2032 Lithium	1 CR2032 Lithium	1 CR2032 Lithium	1 CR2032 Lithium
Operating temperature (°C)	-20 ÷ +55	-20 ÷ +55	-20 ÷ +55	-20 ÷ +55	-20 ÷ +55
Material	Polycarbonate	Polycarbonate	Polycarbonate	Polycarbonate	Polycarbonate

Code	Description
<b>433.92 MHz transmitters</b>	
<b>806TS-0270</b>	TOP44RBN - Four-channel 433.92 MHz rolling code transmitter. 4,294,967,896 combinations.
<b>806TS-0300</b>	TOP42FGN - Two-channel transmitter with new fixed code encoding at 433.92 MHz and self-learning function for TOP, TAM and TWIN series radio controls.
<b>806TS-0310</b>	TOP44FGN - Four-channel transmitter with new fixed code encoding at 433.92 MHz and self-learning function for TOP, TAM and TWIN series radio controls. !da duplicazione!
<b>Dual frequency transmitters, 433.92 MHz and 868.35 MHz</b>	
<b>806TS-0290</b>	TOPD4REN - Four-channel, dual-frequency, rolling code transmitter (Default 868.35 MHz). 4,294,967,896 combinations.
<b>806TS-0330</b>	TOPD4FRN - Four-channel, dual-frequency transmitter with new fixed code encoding (Default 868.35 MHz) and self-learning function for TOP, TAM, TWIN and TTS series radio controls.
<b>Snap-in 433.92 MHz receivers</b>	
001 <b>AF43S</b>	433,92 MHz plug-in radio frequency card.
001 <b>AF43SR</b>	433.92 MHz plug-in radio frequency card for maximum 25 Rolling Code transmitters.
001 <b>AF43TW</b>	433,92 MHz plug-in radio frequency card.
<b>Snap-in 868.35 MHz receivers</b>	
001 <b>AF868</b>	868.35 MHz plug-in radio frequency card.
001 <b>AF868SR</b>	868.35 MHz plug-in radio frequency card for maximum 25 Rolling Code transmitters.



# THE COMPLETE RANGE

## Code Description

### 24 V AC - DC external modules

**806RV-0010** RBE4024 - Four-channel surface-mounted multi-user IP54 receiver module, 24 V AC - DC to store up to 3000 different users (codes), for TOP, TAM, ATOMO D, TWIN and TTS coding.



### 120 - 230 V AC external modules

**806RV-0020** RBE4230 - Four-channel surface-mounted multi-user IP54 receiver module, 120 - 230 V AC to store up to 3000 different users (codes), for TOP, TAM, ATOMO D, TWIN and TTS coding.



### External, 12 - 24 V AC - DC, 433.92 MHz radio receiver

**001RE432M** Two-channel 433.92 MHz surface-mounted IP54 12 - 24 V AC - DC receiver for storing up to 50 different users (codes), with TOP, TAM, ATOMO D, TWIN and TTS coding.



### External, 12 - 24 V AC - DC, 868.35 MHz radio receiver

**001RE862M** Two-channel 868.35 MHz surface-mounted IP54 12 - 24 V AC - DC receiver for storing up to 50 different users (codes), with TOP, TAM, ATOMO D and TTS coding.



### 433.92 MHz antenna for: 001KLED - 001KLED24

**001TOP-A433N** Antenna tuned at 433.92 MHz.



### 868.35 MHz antenna for: 001KLED - 001KLED24

**001TOP-A862N** Antenna tuned at 868.35 MHz.



### Accessories

**001TOP-RG58** Antenna cable L = 5 m.



### Transmitter accessories

**806XG-0020** Pack of no. 2 3V DC CR2032 lithium batteries.



NOTES: for the 806RV-0010 and the 806RV-0020 use the 001AF43S or the 001AF868.





## Swiveling, synchronized infrared-beam safety devices

- Available in the traditional version (black edge) and in the CXN BUS version (blue edge).
- Control the gate's area of movement
- Infrared beam swivels up to 180° on its vertical axis.
- It can synchronize up to eight pairs of photocells, with no disturbances, plus no wiring required between the transmitter and the receiver.
- Also available is the double height post for installing at industrial sites used by very large vehicles.
- Infrared beam range adjustment.
- Filter function to prevent false detections due to bad weather or direct sunlight.
- Settable contact output so the photocell can double as a control device.
- Also available with aluminum alloy casing.
- The 806TF-0060 version, with battery-powered transmitter, also allows to control a sensitive resistive safety-edge to protect the moving gate leaf.

### Dimensions (mm)

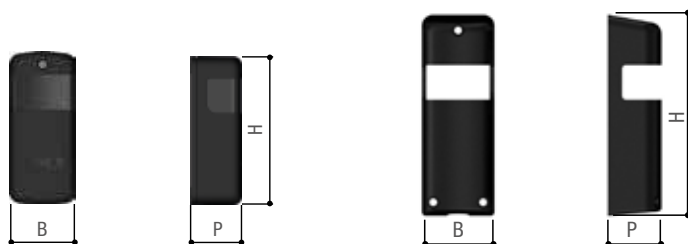

806TF-0030  
806TF-0060  
806TF-0110  
806TF-0120

806TF-0040  
806TF-0050

### Dimensions table (mm)

Models	B (mm)	H (mm)	P (mm)	P + Q (mm)
806TF-0030	46	108	37	-
806TF-0040	52	145	39	-
806TF-0050	52	145	39	-
806TF-0060	46	108	37	-
806TF-0110	46	108	-	37
806TF-0120	29,5	116	29	-

### Operational limits

MODELS	806TF-0030	806TF-0040	806TF-0060	806TF-0110	806TF-0120
Max range of infrared beam (m)	20	20	10	20	20

### Technical characteristics

MODELS	806TF-0030	806TF-0040	806TF-0060	806TF-0110	806TF-0120
Protection rating (IP)	54	54	54	54	54
Power supply (V)	12 - 24 AC - DC	12 - 24 AC - DC	12 - 24 AC - DC (RX)	BUS CXN	12 - 24 AC - DC
Power (W)	-	-	-	0,29	-
Batteries	-	-	1 x CR123A	-	-
Battery capacity (mAh)	-	-	1700	-	-
Maximum rating of output contacts at 24 V (A)	-	-	0.5	-	-
Operating temperature (°C)	-20 ÷ +55	-20 ÷ +55	-20 ÷ +55	-20 ÷ +55	-20 ÷ +55
Material	PC	ABS - Aluminum	ABS	-	PC

Code	Description
<b>Adjustable synchronized infrared beam photocells</b>	
<b>806TF-0030</b> 	DXR20CAP - Pair of surface mounted synchronized, swiveling, infrared-beam photocells rated at 12 - 24 V AC - DC. Range: 20 m.
<b>806TF-0040</b> 	DXR20CAM - Pair of aluminum, surface mounted, synchronized, swiveling, infrared-beam photocells rated at 12 - 24 V AC - DC. Range: 20 m.
<b>806TF-0060</b> 	DXR10BAP - Pair of surface mounted synchronized, swiveling, infrared-beam photocells rated at 12 - 24 V AC - DC and battery transmitter. Range: 10 m.
<b>806TF-0120</b> 	DXR20CTP - Pair of miniature synchronised infrared photocells adjustable 12 - 24 V AC - DC outdoor. Range: 20 m.
<b>Synchronized swiveling infrared beam photocell with BUS CXN technology</b>	
<b>806TF-0110</b> 	DXR20SAP - Pair of surface-mounted synchronized adjustable infra-red beam BUS CXN photocells. Range: 20 m.
<b>Accessories for: 806TF-0030 - 806TF-0060 - 806TF-0110 - 806TF-0120</b>	
<b>806TF-0050</b>	Aluminium alloy cover for DXR series photocells.
001 <b>DIR-L</b>	Natural-finish aluminum post H = 500 mm.
001 <b>DIR-LN</b>	Black anodized aluminum post. H = 500 mm.
001 <b>DIR-CG</b>	Silver RAL9006, PVC post. H = 500 mm.
<b>Accessories for: 806TF-0030 - 806TF-0040 - 806TF-0060 - 806TF-0110 - 806TF-0120</b>	
001 <b>DIR-S</b>	Recess-mounting casing.
<b>Accessories for: 001 DIR-L</b>	
001 <b>DIR-P</b>	Natural-finish, anodized aluminum post-extension for applying to double pair of photocells. H = 500 mm
<b>Accessories for: 001 DIR-LN</b>	
001 <b>DIR-PN</b>	Black, anodized aluminum post-extension for applying to double pair of photocells. H = 500 mm
<b>Accessories for: 001 DIR-CG</b>	
001 <b>DIR-CGP</b>	Silver RAL9006 post extension for fitting with double pair of photocells. H = 500 mm



## THE ADJUSTABLE BEAM PHOTOCELL

Thanks to its adjustable synchronized infrared beam, it is the ideal solution for applications where the installation space and the system structure prevent the perfect alignment of the standard photocells one in front of the other.

## Synchronized infrared-beam safety devices



- Available in the traditional version (black edge) and in the CXN BUS version (blue edge).
- Control the gate's area of movement
- It can synchronize up to eight pairs of photocells, with no disturbances, plus no wiring required between the transmitter and the receiver.
- Adjustment of the infrared beam range from 10 to 30 meters.
- Filter function to prevent false detections due to bad weather or direct sunlight.
- Settable contact output so the photocell can double as a control device.
- Alignment function between transmitter and receiver.

### Dimensions (mm)

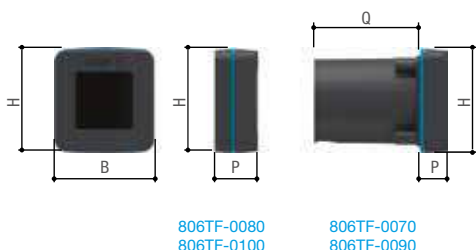

### Dimensions table (mm)

Models	B (mm)	H (mm)	P (mm)	Q (mm)	P + Q (mm)
806TF-0070	70	73	18	78	96
806TF-0080	70	73	30	-	-
806TF-0090	70	73	18	78	96
806TF-0100	70	73	30	-	-

### Operational limits

MODELS	806TF-0070	806TF-0080	806TF-0090	806TF-0100
Max range of infrared beam (m)	30	30	30	30

### Technical characteristics

MODELS	806TF-0070	806TF-0080	806TF-0090	806TF-0100
Protection rating (IP)	54	54	54	54
Power supply (V)	12 - 24 AC - DC	12 - 24 AC - DC	CXN BUS	CXN BUS
Power (W)	-	-	0.29	0.29
Operating temperature (°C)	-20 ÷ +55	-20 ÷ +55	-20 ÷ +55	-20 ÷ +55
Material	PA66	PA66	-	-

Code	Description
<b>Adjustable synchronized infrared beam photocells</b>	
<b>806TF-0070</b> 	DLX30CIP - Pair of built-in synchronized adjustable infrared-beam photocells rated at 12 - 24 V AC - DC. Range: 30 m.
<b>806TF-0080</b> 	DLX30CEP - Pair of surface mounted synchronized adjustable infrared-beam photocells rated at 12 - 24 V AC - DC. Range: 30 m.
<b>Synchronized infrared beam photocell with BUS CXN technology</b>	
<b>806TF-0090</b> 	DLX30SIP - Pair of built-in synchronized infra-red beam BUS CXN photocells. Range: 30 m.
<b>806TF-0100</b> 	DLX30SEP - Pair of surface-mounted synchronized infra-red beam BUS CXN photocells. Range: 30 m.
<b>Accessories for: 806TF-0070 - 806TF-0090</b>	
009 <b>DOC-S</b>	Recess-mounting casing.
001 <b>DOC-L</b>	Anodized aluminum with natural finish post. H = 500 mm.
001 <b>DOC-LN</b>	Black anodized aluminum post. H = 500 mm.
<b>Accessories for: 806TF-0080 - 806TF-0100</b>	
001 <b>DOC-R</b>	Steel brace for flush surface mounting on the post.
001 <b>DELTA-B</b>	Natural-finish anodized aluminum post for bi-directional fitting. H = 500 mm
001 <b>DELTA-BN</b>	Black anodized aluminum post for bi-directional fitting. H = 500 mm





## Safety devices for automated systems

- Control the gate's area of movement
- Synchronized infra-red beam to avoid any external signal interference.
- The double-height post, also in the new PVC version, for installing at points where heavy-duty vehicles transit through is available.
- High degree of protection against weathering.
- Available in 10, 20 and 30 meter versions.
- Also available in the version with aluminum alloy casing.

## Dimensions (mm)

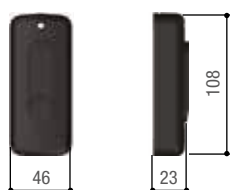

## Operational limits

MODELS	DIR10	DIR20	DIR30
Max. range of radio (m)	10	20	30

## Technical characteristics

MODELS	DIR10	DIR20	DIR30
Protection rating (IP)	54	54	54
Power supply (V)	12 - 24 AC - DC	12 - 24 AC - DC	12 - 24 AC - DC
Operating temperature (°C)	-20 ÷ +55	-20 ÷ +55	-20 ÷ +55
Material	ABS - Polycarbonate	ABS - Polycarbonate	ABS - Polycarbonate

● 12 - 24 V AC - DC

Code	Description
<b>Dir- series, synchronized infrared-beam photocells</b>	
001 <b>DIR10</b> 	Pair of 12 - 24 V AC - DC outdoor photocells – range 10 m.
001 <b>DIR20</b> 	Pair of surface-mounted 12 – 24 V AC – DC photocells. Range: 20 m.
001 <b>DIR30</b> 	Pair of surface-mounted 12 – 24 V AC – DC photocells. Range: 30 m.
<b>Accessories for: 001DIR10 - 001DIR20 - 001DIR30</b>	
001 <b>DIRZ</b>	Aluminum alloy, shock-proof protection.
001 <b>DIR-S</b>	Recess-mounting casing.
001 <b>DIR-L</b>	Natural-finish aluminum post H = 500 mm.
001 <b>DIR-LN</b>	Black anodized aluminum post. H = 500 mm.
001 <b>DIR-CG</b>	Silver RAL9006, PVC post. H = 500 mm.
<b>Accessories for: 001DIR-L</b>	
001 <b>DIR-P</b>	Natural-finish, anodized aluminum post-extension for applying to double pair of photocells. H = 500 mm
<b>Accessories for: 001DIR-LN</b>	
001 <b>DIR-PN</b>	Black, anodized aluminum post-extension for applying to double pair of photocells. H = 500 mm
<b>Accessories for: 001DIR-CG</b>	
001 <b>DIR-CGP</b>	Silver RAL9006 post extension for fitting with double pair of photocells. H = 500 mm



## Slim flashing light for barriers and garage doors



- Slim and modern design that perfectly suits any setting.
- 24V AC/DC power supply.
- Integrated double antenna (433.92 MHz and 868.35 MHz).
- Perfect solution for applications on GARD LT and LS series automatic barriers or for wall installation.
- Traffic light signaling with green, white and red LEDs and possibility of use as a courtesy light.

### Dimensions (mm)



### Technical characteristics

MODELS	806LA-0060
Protection rating (IP)	54
Power supply (V)	24 AC/DC
Radio signal frequency (Mhz)	433 and 868
Power (W)	3
Operating temperature (°C)	-20 ÷ +55
Material	PA6 - PMMA

Code	Description
<b>24 V flashing lights</b>	
<b>806LA-0060</b> 	KLT1FDSW - Green, white and red LED flashing light with 24 V AC/ DC traffic light signaling.
<b>Accessories</b>	
<b>001TOP-RG58</b>	Antenna cable L = 5 m.



## OPERATING MODES

With advanced electronics, KLT features customization of light color and flashing to meet the needs of any user.



## DOUBLE FREQUENCY

KLT features a built-in dual-frequency antenna and is therefore compatible with all CAME radio transmitters with 433MHz and 868 MHz frequency.

## Elegant form and technological innovation



- Sleek design and high-quality materials for a flashing light that offers much more than simple light alerts.
- Unique model with universal power supply from 24 V AC - DC to 230 V AC.
- Available in White, Yellow and Orange.
- Integrated double antenna (433.92 MHz and 868.35 MHz).
- Wall-mounted bracket that solves every installation.
- Availability of 2 versions with CXN BUS technology, with and without built-in gateway, for light signaling management via AppSetup.

## Dimensions (mm)



## Technical characteristics

MODELS	806LA-0010	806LA-0020	806LA-0030	806LA-0050	806LA-0070
Protection rating (IP)	54	54	54	54	54
Power supply (V)	24 DC/AC - 230 AC	24 DC/AC - 230 AC	24 DC/AC - 230 AC	CXN BUS	CXN BUS
Radio signal frequency (Mhz)	433 and 868	433 and 868	433 and 868	433 and 868	433 and 868
Operating temperature (°C)	-20 ÷ +55	-20 ÷ +55	-20 ÷ +55	-20 ÷ +55	-20 ÷ +55
Material	ABS - Polycarbonate	ABS - Polycarbonate	ABS - Polycarbonate	ABS - Polycarbonate - PMMA	ABS - Polycarbonate - PMMA

Code	Description
<b>24 V AC - DC to 230 V AC flashing lights</b>	
<b>806LA-0010</b>	KRX1FXSO - LED flashing light with power supply from 24 V AC - DC up to 230 V AC with orange dome.
<b>806LA-0020</b>	KRX1FXSW - LED flashing light with power supply from 24 V AC - DC up to 230 V AC with white dome.
<b>806LA-0030</b>	KRX1FXSY - LED flashing light with power supply from 24 V AC - DC up to 230 V AC with yellow dome.
<b>Flashing light with BUS CXN technology</b>	
<b>806LA-0050</b>	KRX1B1RW - RGB LED flashing light with white dome and BUS CXN technology.
<b>Flashing light with BUS CXN CONNECT technology</b>	
<b>806LA-0070</b>	KRX1B1CW - Connect RGB LED flashing light with white dome, CXN BUS technology and integrated gateway to connect the operator to the cloud via Wi-Fi or in local mode via Bluetooth (50 users).
<b>Accessories</b>	
<b>806LA-0040</b>	Wall-fastening base for KRX.
<b>Accessories for: 806LA-0010 - 806LA-0020 - 806LA-0030</b>	
001 <b>TOP-RG58</b>	Antenna cable L = 5 m.
<b>Accessories for: 806LA-0050</b>	
<b>806SA-0140</b>	Gateway to connect the automation to the cloud via WiFi or locally via Bluetooth selector (50 users)
<b>806SA-0150</b>	Slave Module to connect the operator to the CAME Connect gateways.
<b>Accessories for: 806LA-0050 - 806LA-0070</b>	
001 <b>AF43S</b>	433,92 MHz plug-in radio frequency card.
001 <b>AF868</b>	868.35 MHz plug-in radio frequency card.



## CXN BUS CONNECT TECHNOLOGY

KRX CONNECT is the version that combines CXN BUS technology with wireless connectivity, making available 2 innovative functions in addition to the RGB LED system.

Thanks to the 806SA-0140 gateway that can be configured in Wi-Fi or Bluetooth® mode, the KRX CONNECT is much more than a flashing light.



## COMPATIBLE WITH AMAZON ALEXA

Thanks to the Wi-Fi gateway, KRX CONNECT enables users to control the automations via Amazon Alexa voice commands, to open and close the gate, stop it or know its status.



## The low-consuming, movement alerter

- Sleek design and high-quality materials for a flashing light that offers much more than simple light alerts.
- Long life and low consumption.
- Energy efficiency is linked to lower consumption.
- Wall mounting bracket that solves any installation.

### Dimensions (mm)

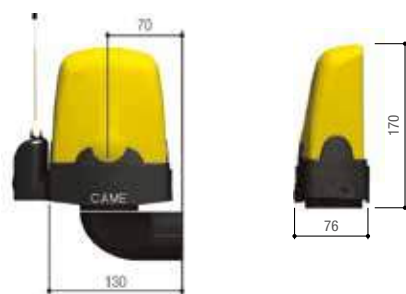

### Technical characteristics

MODELS	KLED	KLED24
Protection rating (IP)	54	54
Power supply (V)	120 - 230 AC 50/60 Hz	24 V AC - DC 50/60 Hz
Power (W)	2 (230 V AC) - 1 (120 V AC)	2
Material	ABS - Polycarbonate	ABS - Polycarbonate

● 120 - 230 V AC ● 24 V AC - DC

Code	Description
<b>120 - 230 V AC Flashing light</b>	
001 <b>KLED</b>	LED flashing light signaller.
<b>24 V AC – DC Flashing light</b>	
001 <b>KLED24</b>	LED flashing light signaller.
<b>Accessories for: 001KLED - 001KLED24</b>	
001 <b>KIAROS</b>	Wall-fastening base.
<b>433.92 Mhz antenna</b>	
001 <b>TOP-A433N</b>	Antenna tuned at 433.92 MHz.
<b>868.35 Mhz antenna</b>	
001 <b>TOP-A862N</b>	Antenna tuned at 868.35 MHz.
<b>Accessories for: 001TOP-A433N - 001TOP-A862N</b>	
001 <b>TOP-RG58</b>	Antenna cable L = 5 m.





## The control for all operators

- Backlit with blue light, available in the surface-mounted or recess-mounted version.
- RAL7024 gray cover.
- Available in the key-operated version with cylinder lock or with European DIN cylinder (even for 230 V applications).
- Versions with BUS CXN technology are available, enabling green and red light feedback.

## Dimensions (mm)

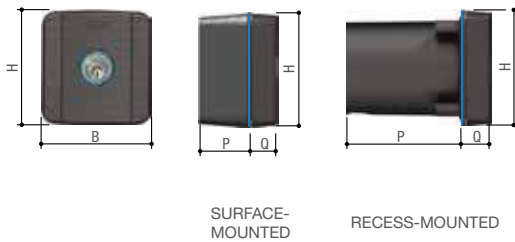

SURFACE-MOUNTED

RECESS-MOUNTED

## Dimensions table (mm)

Models	B (mm)	H (mm)	P (mm)	Q (mm)	P + Q (mm)
806SL-0050	70.5	73.5	47.5	16.5	64
806SL-0060	70.5	73.5	76	16.5	92.5
806SL-0070	70.5	73.5	21	16.5	50
806SL-0080	70.5	73.5	76	16.5	92.5
806SL-0010	70.5	73.5	21	16.5	50
806SL-0020	70.5	73.5	76	16.5	92.5
806SL-0030	70.5	73.5	21	16.5	37.5
806SL-0040	70.5	73.5	76	16.5	92.5
806SL-0090	70.5	73.5	47.5	16.5	64
806SL-0100	70.5	73.5	76	16.5	92.5
806SL-0051	70.5	73.5	47.5	16.5	64
806SL-0061	70.5	73.5	76	16.5	92.5

## Technical characteristics

MODELS	806SL-0050	806SL-0060	806SL-0070	806SL-0080	806SL-0010	806SL-0020
Protection rating (IP)	44	44	44	44	44	44
Power supply (V)	-	-	CXN BUS	CXN BUS	12 - 24 AC - DC	12 - 24 AC - DC
Max. rating of 24 V (A) relay contacts	3	3	-	-	-	-
Operating temperature (°C)	-20 ÷ +55	-20 ÷ +55	-20 ÷ +55	-20 ÷ +55	-20 ÷ +55	-20 ÷ +55
MODELS	806SL-0030	806SL-0040	806SL-0090	806SL-0100	806SL-0051	806SL-0061
Protection rating (IP)	44	44	44	44	44	44
Power supply (V)	CXN BUS	CXN BUS	-	-	-	-
Max. rating of 24 V (A) relay contacts	-	-	-	-	3	3
Operating temperature (°C)	-20 ÷ +55	-20 ÷ +55	-20 ÷ +55	-20 ÷ +55	-20 ÷ +55	-20 ÷ +55

Code	Description
<b>Key-switch selectors with DIN lock</b>	
<b>806SL-0050</b> 	SELD1FDG - surface-mounted key-switch selector with blue backlight and DIN lock cylinder. RAL7024 Gray color.
<b>806SL-0060</b> 	SELD2FDG - Recess-mounted key-switch selector with blue backlight and DIN lock cylinder. RAL7024 Gray color.
<b>8K06SL-004</b> 	SELD1K01 - Kit consisting of two surface-mounted key-switch selectors with blue backlighting and DIN lock cylinder. RAL7024 gray color.
<b>8K06SL-005</b> 	SELD2K01 - Kit consisting of two recess-mounted key-switch selectors with blue backlighting and DIN lock cylinder. RAL7024 gray color.
<b>Key-switch selectors with DIN lock and BUS CXN technology</b>	
<b>806SL-0070</b> 	SELD1BDG - BUS CXN surface-mounted key-switch selector with blue backlight and DIN lock cylinder. RAL7024, gray color.
<b>806SL-0080</b> 	SELD2BDG - BUS CXN recess-mounted key-switch selector with blue backlight and DIN lock cylinder. RAL7024, gray color.
<b>Key-switch selectors with cylinder locks</b>	
<b>806SL-0010</b> 	SELC1FDG - Surface-mounted key-switch selector with blue backlight and cylinder lock. RAL7024 Gray color.
<b>806SL-0020</b> 	SELC2FDG - Recess-mounted key-switch selector with blue backlight and cylinder lock. RAL7024 Gray color.
<b>Key-switch selectors with cylinder lock and BUS CXN technology</b>	
<b>806SL-0030</b> 	SELC1BDG - BUS CXN surface-mounted key-switch selector with blue backlight and lock cylinder. RAL7024, gray color.
<b>806SL-0040</b> 	SELC2BDG - Recess-mounted key-switch selector with blue backlight and lock cylinder. RAL7024, gray color.
<b>Key-switch selectors with DIN lock for 230 V AC controls</b>	
<b>806SL-0090</b>	SELD1FAG - Surface-mounted key-switch selector and DIN lock cylinder for 230 V controls. RAL7024 Gray color.
<b>806SL-0100</b>	SELD2FAG - Recess-mounted key-switch selector and DIN lock cylinder for 230 V controls. RAL7024 Gray color.
<b>Accessories for recess mounted selector switches</b>	
001 <b>CSS</b>	Post made of natural-finish, anodized aluminum.
001 <b>CSSN</b>	Post made of black, anodized aluminum.
<b>Key-switch selectors without DIN lock.</b>	
<b>806SL-0051</b> 	SELD1FDS - Surface-mounted key-switch selector with blue backlighting, without DIN lock cylinder. RAL7024 gray color.
<b>806SL-0061</b> 	SELD2FDS - Recess-mounted key-switch selector with blue backlighting, without DIN lock cylinder. RAL7024 gray color.



NOTES: 806SL-0051 - 806SL-0061  
For DIN lock cylinders, see spare part 119R36887 (from code 002 to code 050).



## The digital control for all automated operators

- Backlit with blue light, available in the surface-mounted or recess-mounted version.
- Green and red feedback light on CXN BUS versions.
- RAL7024 gray cover.
- 12-key keypad for extra security.
- Transponder selector for Mifare/Manchester cards.
- Bluetooth selector with CAME AUTOMATIONBT APP free for IOS and Android.
- Bluetooth plug-in selector version also available.

### Dimensions (mm)

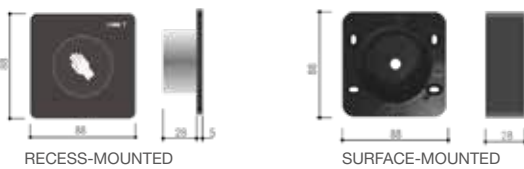
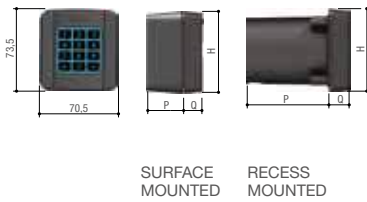

### Dimensions table (mm)

Models	B (mm)	H (mm)	P (mm)	Q (mm)	P + Q (mm)
806SL-0170	70,5	73,5	33,5	16,5	50
806SL-0180	70,5	73,5	33,5	16,5	50
806SL-0340	70,5	73,5	76	16,5	37,5
806SL-0350	70,5	73,5	76	16,5	37,5
806SL-0360	70,5	73,5	76	16,5	37,5
806SL-0300	70,5	73,5	21	16,5	37,5
806SL-0310	70,5	73,5	76	16,5	92,5
806SL-0280	70,5	73,5	21	16,5	37,5
806SL-0290	70,5	73,5	76	16,5	92,5
806SL-0260	88	88	28	5	33
806SL-0270	88	88	-	5	5

### Technical characteristics

MODELS	806SL-0170	806SL-0180	806SL-0340	806SL-0350	806SL-0360	806SL-0260
Protection rating (IP)	54	54	54	54	54	54
Power supply (V)	-	-	12 - 24 AC - DC	12 - 24 AC - DC	12 - 24 AC - DC	12 - 24 AC - DC
Radio signal frequency (Mhz)	-	-	-	-	-	-
Power (W)	0,144	0,144	0,75	0,75	0,75	0,7
Max. rating of 24 V (A) relay contacts	-	-	-	-	-	1
Operating temperature (°C)	-20 ÷ +55	-20 ÷ +55	-20 ÷ +55	-20 ÷ +55	-20 ÷ +55	-20° ÷ +55°
MODELS	806SL-0300	806SL-0310	806SL-0320	806SL-0330	806SL-0280	806SL-0290
Protection rating (IP)	54	54	54	54	54	54
Power supply (V)	12 - 24 AC - DC	12 - 24 AC - DC	15 DC	15 DC	12 - 24 AC - DC	12 - 24 AC - DC
Radio signal frequency (Mhz)	-	-	13,56	13,56	-	-
Power (W)	0,35	0,35	0,97	0,97	0,35	0,35
Max. rating of 24 V (A) relay contacts	-	-	-	-	-	-
Operating temperature (°C)	-20 ÷ +55	-20 ÷ +55	-20 ÷ +55	-20 ÷ +55	-20 ÷ +55	-20 ÷ +55

● 12 - 24 V AC - DC

Code	Description
<b>433.92 MHz keypad radio selectors</b>	
<b>806SL-0170</b> 	SELT1W4G - 433.92 MHz surface-mounted, 12-key radio keypad selector, with blue backlight, 25 savable codes and password to access the programming mode. Settable in Rolling Code or Fixed Code mode. RAL7024 Gray color.
<b>8K06SL-008</b> 	SELT1K02 - Kit composed of a dual-channel receiver board (001RE432M) and 433 MHz radio keyboard selector (806SL-0170).
<b>868.35 MHz keypad radio selectors</b>	
<b>806SL-0180</b> 	SELT1W8G - 868.35 MHz surface-mounted, 12-key radio keypad selector, with blue backlight, 25 savable codes and password to access the programming mode. Settable in Rolling Code or Fixed Code mode. RAL7024 Gray color.
<b>Keypad selectors with BUS CXN technology</b>	
<b>806SL-0280</b> 	SELT1BDG - Surface-mounted 12-key BUS CXN keypad selector with blue backlighting. RAL7024 gray color.
<b>806SL-0290</b> 	SELT2BDG - Recess-mounted 12-key BUS CXN keypad selector with blue backlighting. RAL7024 gray color.
<b>8K06SL-006</b> 	SELT1K01 - Kit composed of interface board S0002P and external BUS keypad.
<b>Accessories for wired keypad selectors</b>	
001 <b>R800</b>	Control board for decoding and access-control management via keypad selectors.
<b>Transponder sensors with BUS CXN technology</b>	
<b>806SL-0300</b> 	SELR1BDG - Surface-mounted BUS CXN transponder selector for cards, keyfobs and TAG (Manchester protocol) with blue backlighting. RAL7024 gray color.
<b>806SL-0310</b> 	SELR2BDG - Recess-mounted BUS CXN transponder selector for cards, keyfobs and TAG (Manchester protocol) with blue backlighting. RAL7024 gray color.
<b>8K06SL-007</b> 	SELR1K01 - Kit consisting of interface board S0002P, surface-mounted Bus Transponder and 2 RFID boards (Manchester - 125 KHz).
<b>Accessories for Manchester transponder selectors</b>	
001 <b>R700</b>	Control board for decoding and access-control management via transponder selector.
009 <b>PCT</b>	Keyfob transponder.
<b>806XG-0090</b>	Transponder card, ISO 7810 - 7813 format, Manchester 125 KHz protocol.
<b>Mifare transponder sensors with BUS CXN technology</b>	
<b>806SL-0320</b> 	SELM1BDG - Surface-mounted BUS transponder selector for MIFARE cards with blue backlighting. RAL7024, gray color.
<b>806SL-0330</b> 	SELM2BDG - Recess-mounted BUS transponder selector for MIFARE cards with blue backlighting. RAL7024, gray color.
<b>8K06SL-009</b> 	SELM1K01 - Kit composed of S0002P dual-channel interface card (806SL-0370), external MIFARE BUS transponder selector (806SL-0320) and 2 MIFARE cards (806XG-0100).
<b>Accessories for Mifare transponder selectors</b>	
001 <b>R700</b>	Control board for decoding and access-control management via transponder selector.
<b>806XG-0100</b>	ISO MIFARE Classic 1 K - 13.56 MHz card.



# THE COMPLETE RANGE

## Code Description

### Bluetooth digital selectors with BUS CXN technology

**806SL-0340** SELB1NDG1 - Surface mounted BUS bluetooth selector for 15 users with blue backlight for use even on automations without BUS technology.



**806SL-0350** SELB1NDG2 - Surface mounted BUS bluetooth selector for 50 users with blue backlight for use even on automations without BUS technology.



**806SL-0360** SELB1NDG3 - Surface mounted BUS bluetooth selector for 250 users with blue backlight for use even on automations without BUS technology.



### External 12 - 24 V AC - DC 433.92 MHz radio receivers for: 806SL-0170

**001RE432M** Two-channel 433.92 MHz surface-mounted IP54 12 - 24 V AC - DC receiver for storing up to 50 different users (codes), with TOP, TAM, ATOMO D, TWIN and TTS coding.



### External 12 - 24 V AC - DC 868.35 MHz radio receivers for: 806SL-0180

**001RE862M** Two-channel 868.35 MHz surface-mounted IP54 12 - 24 V AC - DC receiver for storing up to 50 different users (codes), with TOP, TAM, ATOMO D and TTS coding.



### 12 - 24 V AC - DC external modules for: radio-based transponders, keypads and selectors

**806RV-0010** RBE4024 - Four-channel surface-mounted multi-user IP54 receiver module, 24 V AC - DC to store up to 3000 different users (codes), for TOP, TAM, ATOMO D, TWIN and TTS coding.



### 120 - 230 V AC external modules for: transponder, keypad and radio-based selectors

**806RV-0020** RBE4230 - Four-channel surface-mounted multi-user IP54 receiver module, 120 - 230 V AC to store up to 3000 different users (codes), for TOP, TAM, ATOMO D, TWIN and TTS coding.



### 433.92 MHz plug-in receivers for: 806SL-0170

**001AF43S** 433,92 MHz plug-in radio frequency card.



**001AF43SR** 433.92 MHz plug-in radio frequency card for maximum 25 Rolling Code transmitters.



### Snap-in 868.35 MHz receivers for: 806SL-0180

**001AF868** 868.35 MHz plug-in radio frequency card.



**001AF868SR** 868.35 MHz plug-in radio frequency card for maximum 25 Rolling Code transmitters.



### 12 - 24 V AC - DC microwave sensor

**806SL-0260** SELS2SDG - Recess-mounted 12 - 24 V AC - DC touch sensor, with settable backlight.



### Accessories for: 806SL-0260

**806SL-0270** Surface-mounted casing.



Bluetooth digital plug-in selectors	
<b>806SA-0140</b> 	Gateway to connect the automation to the cloud via WiFi or locally via Bluetooth selector (50 users)
CXN BUS interface for automations	
<b>806XG-0080</b> 	BUS expansion module with 2 inputs and 2 outputs. Inputs can be configured in NO, NC or resistive mode (8K2), a warning light output and a relay output.
Accessories for keypad and transponders selectors	
<b>806SL-0370</b> 	S0002P - Surface-mounted IP54 12 - 24 V AC - DC dual-channel control card for keypads and transponders.
24 V AC - DC magnetic sensors	
<b>009SMA</b> 	Single.-channel magnetic sensor for detecting metal masses.
<b>009SMA2</b> 	Two-channel magnetic sensor for detecting metal masses.
230 V AC magnetic sensors	
<b>009SMA220</b>	Single.-channel magnetic sensor for detecting metal masses.
868.35 MHz antenna for: 001KLED - 001KLED24 - 806SL-0180	
<b>001TOP-A862N</b>	Antenna tuned at 868.35 MHz.
Antenna at 433.92 MHz for: 001KLED - 001KLED24 - 806SL-0170	
<b>001TOP-A433N</b>	Antenna tuned at 433.92 MHz.
Accessories	
<b>001TOP-RG58</b>	Antenna cable L = 5 m.



## DOWNLOAD THE CAME AUTOMATIONBT APP

AutomationBT is CAME's new app for Bluetooth selectors that lets you control your automated operators via smartphone. Activate the location service, receive alerts and open the gate. The Keyless function lets you even do it automatically.





## Modular radio receivers

- Management of up to 3000 users (RBE),
- Management of up to 50 users (RE).
- Available in the versions powered by 12 - 24 V AC - DC or 120 - 230 V AC.
- Manages all codes: TOP - TAM - TWIN - ROLLING CODE by using the AF43S or the AF868 boards, depending on the requested frequency.
- Possibility to set all CAME codes or only the Rolling Code or only the Key Code.
- Three different uses depending on the plug-in card used:
  - 433.92 MHz or 868.35 MHz receiver
  - Management of two transponder readers with plug-in card 001R700
  - Management of five keypads with the plug-in card

## Dimensions (mm)

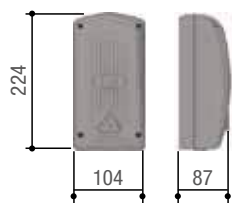

001RE432M  
001RE862M

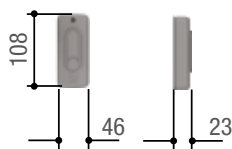

806RV-0010  
806RV-0020

## Technical characteristics

MODELS	RE432M	RE862M	806RV-0010	806RV-0020
Protection rating (IP)	65	65	65	65
Power supply (V)	12 - 24 AC - DC	12 - 24 AC - DC	12 - 24 AC - DC	120 - 230 V AC
Radio signal frequency (Mhz)	433,92	868,35	433,92 - 868,35	433,92 - 868,35
Operating temperature (°C)	-20° ÷ 55°C	-20° ÷ 55°C	-20° ÷ 55°C	-20° ÷ 55°C

● 12 - 24 V AC - DC

Code	Description
<b>433.92 MHz radio receivers</b>	
001 <b>RE432M</b> 	Two-channel 433.92 MHz surface-mounted IP54 12 - 24 V AC - DC receiver for storing up to 50 different users (codes), with TOP, TAM, ATOMO D, TWIN and TTS coding.
<b>868.35 MHz radio receivers</b>	
001 <b>RE862M</b> 	Two-channel 868.35 MHz surface-mounted IP54 12 - 24 V AC - DC receiver for storing up to 50 different users (codes), with TOP, TAM, ATOMO D and TTS coding.
<b>12 - 24 V AC - DC external modules</b>	
<b>806RV-0010</b> 	RBE4024 - Four-channel surface-mounted multi-user IP54 receiver module, 24 V AC - DC to store up to 3000 different users (codes), for TOP, TAM, ATOMO D, TWIN and TTS coding.
<b>120 - 230 V AC external modules</b>	
<b>806RV-0020</b> 	RBE4230 - Four-channel surface-mounted multi-user IP54 receiver module, 120 - 230 V AC to store up to 3000 different users (codes), for TOP, TAM, ATOMO D, TWIN and TTS coding.



## DOWNLOAD THE CONNECT SETUP APP

The app dedicated to CAME installers that simplifies system installation and maintenance operations. The new CONNECT SetUp App is used to configure the operators, make diagnoses, manage remote controls, read the technical documentation, thanks to a simple and intuitive interface, directly from a smartphone or tablet. Available for PC, iOS and Android.



# THE COMPLETE RANGE

## Code Description

### 433.92 MHz radio accessories for: 806RV-0010 - 806RV-0020

001**TOP-A433N** Antenna tuned at 433.92 MHz.

001**AF43S** 433,92 MHz plug-in radio frequency card.

**806SL-0170**  SELT1W4G - 433.92 MHz surface-mounted, 12-key radio keypad selector, with blue backlight, 25 savable codes and password to access the programming mode. Settable in Rolling Code or Fixed Code mode. RAL7024 Gray color.

### 868.35 MHz radio accessories for: 806RV-0010 - 806RV-0020

001**TOP-A862N** Antenna tuned at 868.35 MHz.

001**AF868** 868.35 MHz plug-in radio frequency card.

**806SL-0180**  SELT1W8G - 868.35 MHz surface-mounted, 12-key radio keypad selector, with blue backlight, 25 savable codes and password to access the programming mode. Settable in Rolling Code or Fixed Code mode. RAL7024 Gray color.

### Accessories for antenna

001**TOP-RG58** Antenna cable L = 5 m.

### Accessories for keypad operation

001**R800** Control board for decoding and access-control management via keypad selectors.

**806SL-0280**  SELT1BDG - Surface-mounted 12-key BUS CXN keypad selector with blue backlighting. RAL7024 gray color.

**806SL-0290**  SELT2BDG - Recess-mounted 12-key BUS CXN keypad selector with blue backlighting. RAL7024 gray color.

### Accessories for operation with Manchester transponders

001**R700** Control board for decoding and access-control management via transponder selector.

**806SL-0300**  SELR1BDG - Surface-mounted BUS CXN transponder selector for cards, keyfobs and TAG (Manchester protocol) with blue backlighting. RAL7024 gray color.



**806SL-0310**  SELR2BDG - Recess-mounted BUS CXN transponder selector for cards, keyfobs and TAG (Manchester protocol) with blue backlighting. RAL7024 gray color.

009**PCT** Keyfob transponder.

**806XG-0090** Transponder card, ISO 7810 - 7813 format, Manchester 125 KHz protocol.

### Accessories for operation with MIFARE transponders

001**R700** Control board for decoding and access-control management via transponder selector.

**806SL-0320**   SELM1BDG - Surface-mounted BUS transponder selector for MIFARE cards with blue backlighting. RAL7024, gray color.

**806SL-0330**   SELM2BDG - Recess-mounted BUS transponder selector for MIFARE cards with blue backlighting. RAL7024, gray color.

**806XG-0100** ISO MIFARE Classic 1 K - 13.56 MHz card.



# REMOTE CONTROL

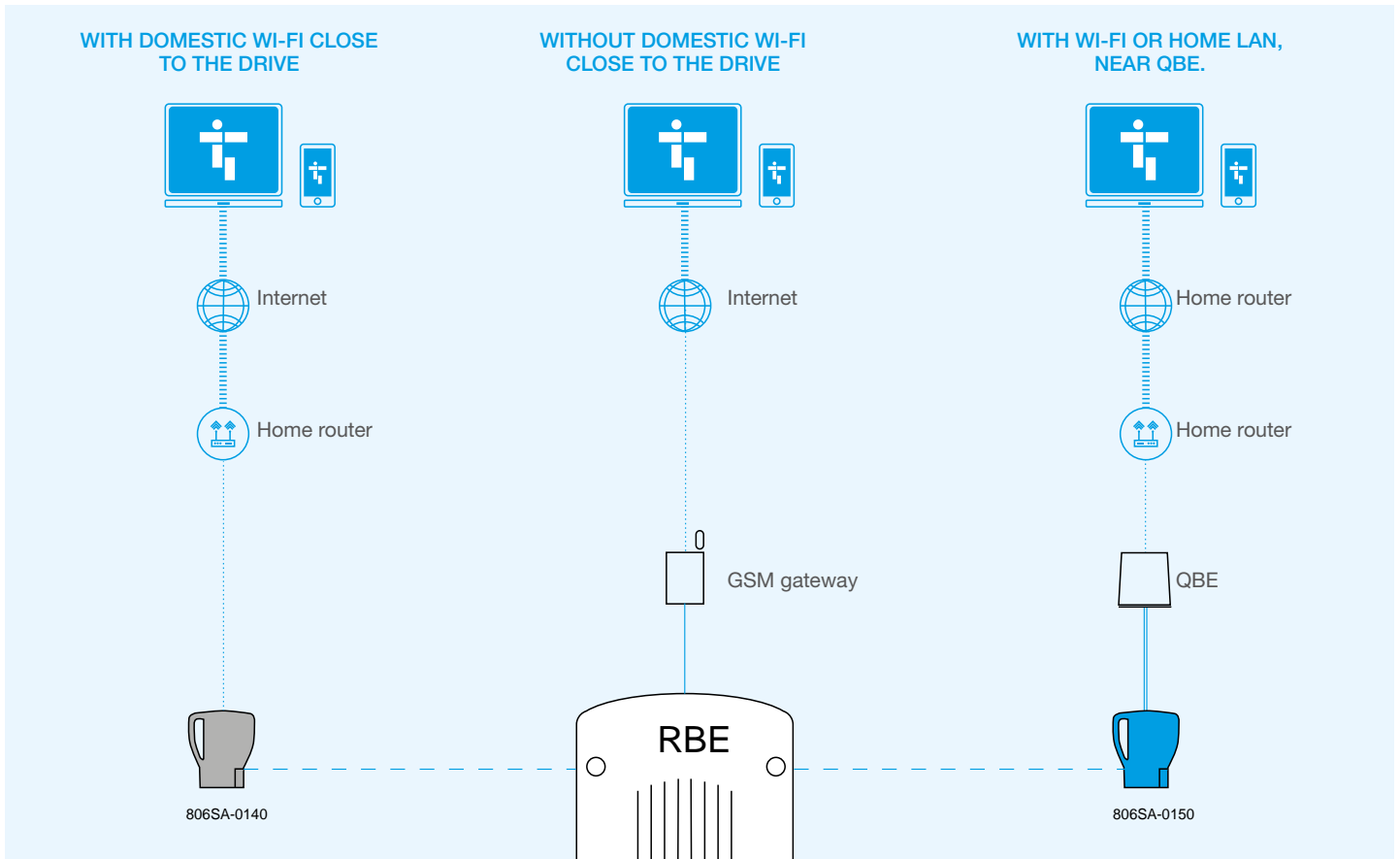

# ACCESSORIES CONNECTION

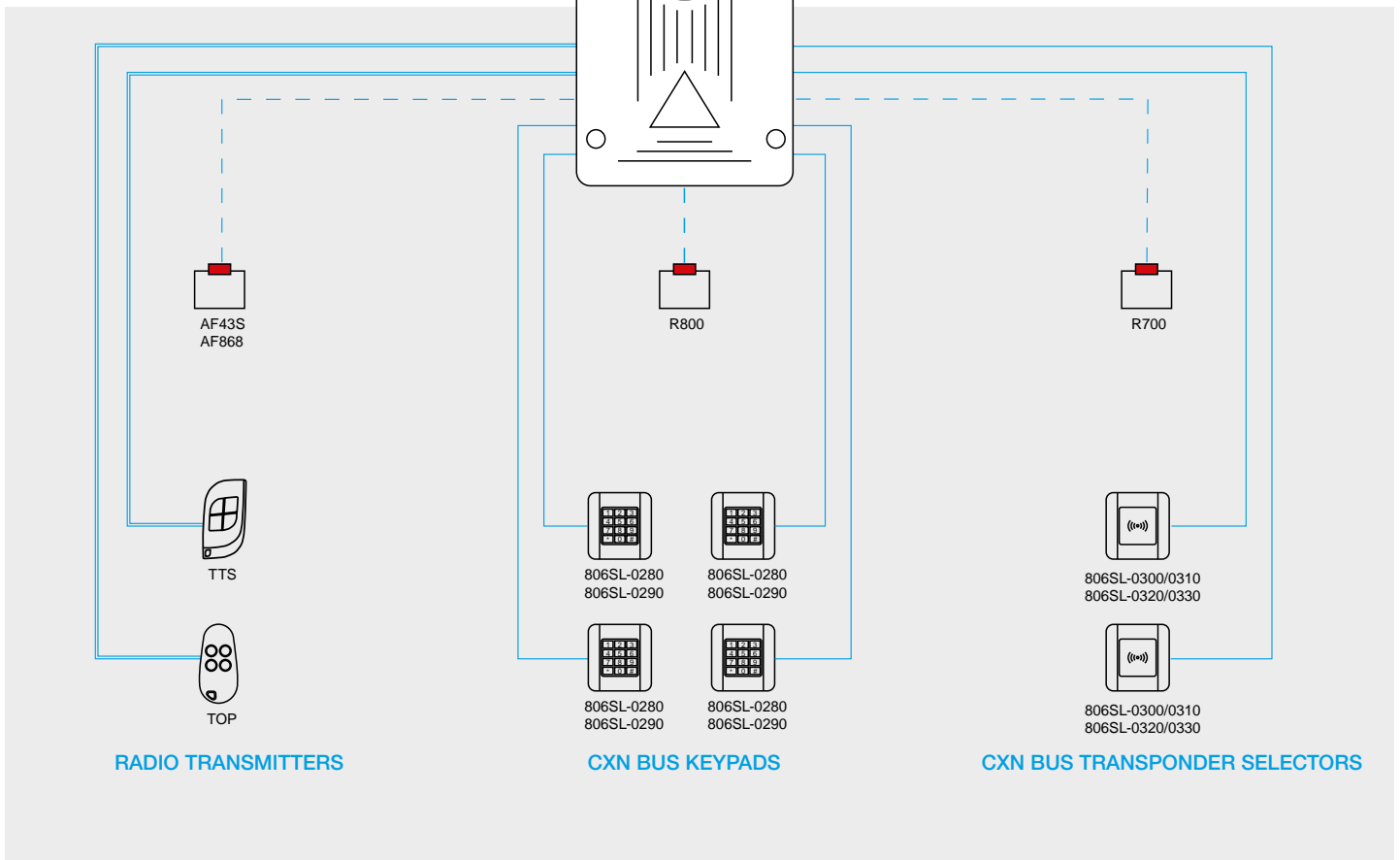

DATA NETWORK

WI-FI

PLUG-IN

RADIO FREQUENCY

WIRED

Notes:  
 Remote controls, keypads or transponder selectors can only be connected for one type of accessory.



## Technology to control automated operators from any remote location

- Developed with CONNECT technology for remote digital control via gateway or locally via CAME KEY.
- Freedom of installation by choosing the appropriate connection type (Wi-Fi-Ethernet-GSM).
- Possibility to extend the system using slave modules (806SA-0040 - 806SA-0150).
- Thanks to the CAME protocol it is possible to have total control of the operator (commands, automation status, programming).
- Possibility to program scenarios and timers, easily and intuitively.
- Thanks to two output relays and two digital inputs, integrated in the unit, the operator opening or closing can be controlled without the CAME protocol (806SA-0010 - 806SA-0020).
- The basic GSM version without built-in radio-frequency module is also available (806SA-0030).
- CAME AUTOMATION APP and CAME SETUP can be freely downloaded from Google Play or App Store.

### Dimensions (mm)

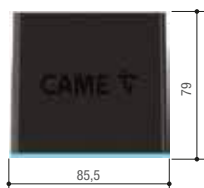

842EC-0020  
806SA-0130

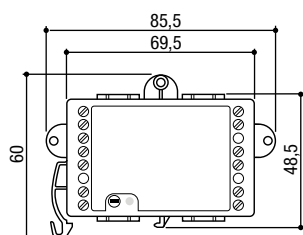

806SA-0010  
806SA-0020

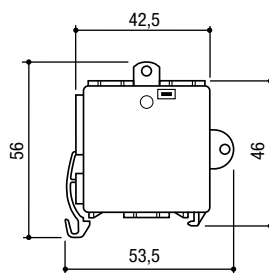
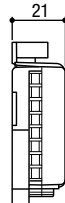

806SA-0040

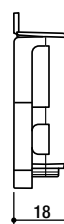

### Technical characteristics

MODELS	842EC-0020	806SA-0130	806SA-0010	806SA-0020	806SA-0040
Protection rating (IP)	30	30	-	-	-
Power supply (V)	5 DC	5 DC	12 - 30 AC - DC	12 - 30 AC - DC	12 - 30 AC - DC
Radio signal frequency (Mhz)	868,65 - 869,50	869,50	-	-	869,50
Data connection technologies	Wi-Fi - Ethernet	Wi-Fi - Ethernet	GSM	GSM	-
Power (W)	-	-	3	3	-
Operating temperature (°C)	+5 ÷ +40	+5 ÷ +40	-20 ÷ +70	-20 ÷ +70	-20 ÷ +70

● 230 V AC ● 24 V DC

Code	Description
<b>Ethernet and WiFi Gateways</b>	
<b>842EC-0020</b> 	QBEDFSB1 - Radio-frequency and WiFi Smart Home Gateway, with one App to manage all connected devices, remotely or on site.
<b>806SA-0130</b> 	QBEMFSB2 - Ethernet-WiFi Gateway for controlling, via the CAME Connect system, up to five slave modules over the radio-frequency connection.
<b>Wi-Fi gateways</b>	
<b>806SA-0140</b> 	Gateway to connect the automation to the cloud via WiFi or locally via Bluetooth selector (50 users)
<b>GSM Gateways</b>	
<b>806SA-0010</b> 	RGSM001 - GSM Gateway module with built-in radio, for remote control of CAME automated operators with the CAME CONNECT dedicated system (002RSE module included). For controlling up to five slave modules.
<b>806SA-0020</b> 	RGSM001S - Stand-alone GSM Gateway module for remote control of CAME automated operators with the CAME CONNECT dedicated system (002RSE module included).
<b>Accessories for: 806SA-0010 - 806SA-0030 - 806SA-0130 - 842EC-0020</b>	
<b>806SA-0150</b> 	Slave Module to connect the operator to the CAME Connect gateways.
<b>806SA-0040</b> 	RSLV001 - Slave module for operators (002RSE module included).
<b>Accessories for GSM Gateway</b>	
<b>806SA-0050</b>	Two-metre long antenna cable



## DOWNLOAD THE CAME AUTOMATION APP

The Cloud connection changes the way we experience our automated operators, by ensuring comfort and safety. We have put all our CAME Connect automated products online. In this way they can be controlled from any smartphone or tablet.





## Sensitive edges certified for total protection

- An exclusive CAME patent for protection against any mechanical risk.
- The solution for high levels of safety and quality of your automated system.
- Mechanical or resistive contact (8K2Ω).
- Specific for using with RIO System 2.0 (requires items 806SS-0010 - 806SS-0040 - 806SS-0050), or DXR photocells (item 806TF-0060).
- A product that complies with standard EN13849-1.
- Available in both light gray and black versions.

## Dimensions (mm)

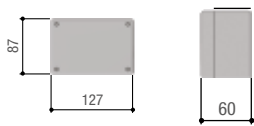

001DFI

## Technical characteristics

MODELS	DFWN1500 / DFWN1500N		DFWN1700 / DFWN1700N		DFWN2000 / DFWN2000N		DFWN2500 / DFWN2500N	
Protection rating (IP)	54	54	54	54	54	54	54	54
Maximum speed measured at the end of the leaf (m/min)	12	12	12	12	12	12	12	12
Operating temperature (°C)	-20 ÷ +55	-20 ÷ +55	-20 ÷ +55	-20 ÷ +55	-20 ÷ +55	-20 ÷ +55	-20 ÷ +55	-20 ÷ +55
Material	TPE 65 SHORT A	TPE 65 SHORT A	TPE 65 SHORT A	TPE 65 SHORT A	TPE 65 SHORT A	TPE 65 SHORT A	TPE 65 SHORT A	TPE 65 SHORT A

Code	Description
<b>Sensitive safety-edges</b>	
001DFWN1500	Sensitive safety edge made of rubber, with mechanical contact. L = 1500 mm. Colour light grey RAL 7040.
001DFWN1700	Sensitive safety edge made of rubber, with mechanical contact. L = 1700 mm. Colour light grey RAL 7040.
001DFWN2000	Sensitive safety edge made of rubber, with mechanical contact. L = 2000 mm. Colour light grey RAL 7040.
001DFWN2500	Sensitive safety edge made of rubber, with mechanical contact. L = 2500 mm. Colour light grey RAL 7040.
001DFWN1500N	Sensitive safety edge made of rubber, with mechanical contact. L = 1500 mm. Colour black RAL 9005.
001DFWN1700N	Sensitive safety edge made of rubber, with mechanical contact. L = 1700 mm. Colour black RAL 9005.
001DFWN2000N	Sensitive safety edge made of rubber, with mechanical contact. L = 2000 mm. Colour black RAL 9005.
001DFWN2500N	Sensitive safety edge made of rubber, with mechanical contact. L = 2500 mm. Colour black RAL 9005.
<b>Components for assembling the sensitive safety-edges of up to 4 m. (max.).</b>	
009RV117H	Aluminum profile L = 2,000 mm.
009RV118I	Rubber profile L = 4,000 mm. Color light gray RAL 7040.
001TMFW	Package of caps and mechanisms. Color light gray RAL 7040.
009RV118N	Rubber profile L = 4,000 mm. Color black RAL 9005
001TMFWN	Package of caps and mechanisms. Color black RAL 9005
<b>Components for assembling sensitive safety-edges of up to 6 m (max.)</b>	
009RV117H	Aluminum profile L = 2,000 mm.
009RV118A	Rubber profile L = 6,000 mm. Color light gray RAL 7040.
001TMF6W	Package of caps and mechanisms. Color light gray RAL 7040.
009RV118M	Rubber profile L = 6,000 mm. Color black RAL 9005
001TMF6WN	Package of caps and mechanisms. Color black RAL 9005
<b>Cordless control for resistive edges</b>	
806TF-0060	DXR10BAP - Pair of surface mounted synchronized, swiveling, infrared-beam photocells rated at 12 - 24 V AC - DC and battery transmitter. Range: 10 m.
<b>Components for: sensitive safety-edges</b>	
806SS-0060	ECN3F242 – Device for wired control in cat.3 for 8.2 KOhm resistive safety edges.





## Resistive sensitive safety edges for total protection

- The right solutions for a high level of safety and quality of your automation system.
- Choose a ready-to-use sensitive safety edge in 4 different lengths or compose your custom profile.
- Each sensitive edge (model H-I-L) can be shortened using the dedicated scissors (806ED-0171).
- All sensitive edges are of the resistive type (8K2).
- Specific for using with RIO System 2.0 (requires items: 806SS-0010 - 806SS-0040 - 806SS-0050).
- The EDG series wired sensitive edge control device (806SS-0060) is available, certified in category 3 and corresponding to Performance Level E, according to EN ISO 13849-1.

### Dimensions (mm)

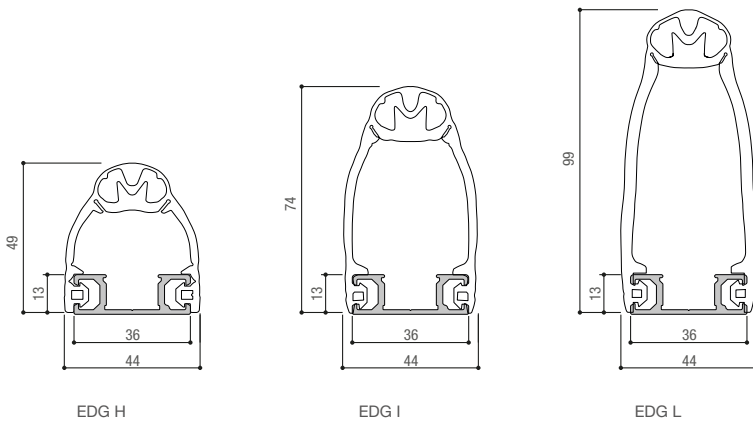

### Technical characteristics

MODELS	EDG H / I / L
Protection rating (IP)	67
Operating temperature (°C)	-20 ÷ +60
Material	EPDM
Cable length (m)	5
Resistor (Ω)	8.2 (0.6 W)

See the SENSITIVE EDGES catalog for full details.

Code	Description
<b>EDG H - Cuttable resistive safety edges with Click-Fit base - H = 49 mm</b>	
<b>806ED-0130</b>	EDGH15R1 - Resistive safety sensitive edge, rubber with profile dimensions 44 mm x 49 mm. L = 1500 mm.
<b>806ED-0131</b>	EDGH17R1 - Resistive safety sensitive edge, rubber with profile dimensions 44 mm x 49 mm. L = 1700 mm.
<b>806ED-0132</b>	EDGH20R1 - Resistive safety sensitive edge, rubber with profile dimensions 44 mm x 49 mm. L = 2000 mm.
<b>806ED-0133</b>	EDGH25R1 - Resistive safety sensitive edge, rubber with profile dimensions 44 mm x 49 mm. L = 2500 mm.
<b>EDG I - Cuttable resistive safety edges with Click-Fit base - H = 74 mm</b>	
<b>806ED-0140</b>	EDGI15R1 - Resistive safety sensitive edge, rubber with profile dimensions 44 mm x 74 mm. L = 1500 mm.
<b>806ED-0141</b>	EDGI17R1 - Resistive safety sensitive edge, rubber with profile dimensions 44 mm x 74 mm. L = 1700 mm.
<b>806ED-0142</b>	EDGI20R1 - Resistive safety sensitive edge, rubber with profile dimensions 44 mm x 74 mm. L = 2000 mm.
<b>806ED-0143</b>	EDGI25R1 - Resistive safety sensitive edge, rubber with profile dimensions 44 mm x 74 mm. L = 2500 mm.
<b>EDG L - Cuttable resistive safety edges with Click-Fit base - H = 99 mm</b>	
<b>806ED-0150</b>	EDGL15R1 - Resistive safety sensitive edge, rubber with profile dimensions 44 mm x 99 mm. L = 1500 mm.
<b>806ED-0151</b>	EDGL17R1 - Resistive safety sensitive edge, rubber with profile dimensions 44 mm x 99 mm. L = 1700 mm.
<b>806ED-0152</b>	EDGL20R1 - Resistive safety sensitive edge, rubber with profile dimensions 44 mm x 99 mm. L = 2000 mm.
<b>806ED-0153</b>	EDGL25R1 - Resistive safety sensitive edge, rubber with profile dimensions 44 mm x 99 mm. L = 2500 mm.
<b>Accessories for resistive sensitive edges</b>	
<b>806SS-0060</b>	ECN3F242 – Device for wired control in cat.3 for 8.2 KOhm resistive safety edges.
<b>Cordless control for resistive edges</b>	
<b>806TF-0060</b>	DXR10BAP - Pair of surface mounted synchronized, swiveling, infrared-beam photocells rated at 12 - 24 V AC - DC and battery transmitter. Range: 10 m.



# THE COMPLETE RANGE

Code	Description
------	-------------

Components for installing the sensitive safety-edges

**806ED-0160** Rubber profile with dimensions 44 mm x 49 mm.  
L = 25 m.

**806ED-0161** Rubber profile with dimensions 44 mm x 74 mm.  
L = 25 m.

**806ED-0162** Rubber profile with dimensions 44 mm x 99 mm.  
L = 25 m.

**806ED-0163** Aluminum profile (10 pcs).  
L = 2 m.

**806ED-0164** Contact terminals (20 pcs).

**806ED-0165** 8k2 Ohm resistive contact terminals (10 pcs).

**806ED-0166** Caps for profile size 44 mm x 49 mm (20 pcs).

**806ED-0167** Caps for profile size 44 mm x 74 mm (20 pcs).

**806ED-0168** Caps for profile size 44 mm x 99 mm (20 pcs).

**806ED-0169** Connection cable L= 2 m (10 pz).

**806ED-0170** Serial connection cable L= 2 m (10 pz).

**806ED-0171** Scissors for rubber profiles.





# RIO System 2.0

Wireless security system



24 V



RIO SYSTEM 2.0



WIRELESS



## Total safety today is also cordless

- Save on fitting times compared to traditional installations.
- No digging or masonry work required.
- No cables to lay.
- Elegant, low-key design.
- Compatible with any control panel.
- Total safety in compliance with European standards.
- Immediately brings your systems up to code, even if they are non compliant.
- Reduced consumption.
- Malfunction and low-battery alerts.

## Dimensions (mm)



806SS-0030

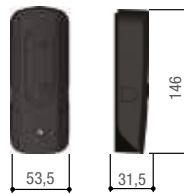

806SS-0010  
806SS-0020



806SS-0050

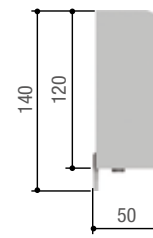

## Operational limits

MODELS	806SS-0010	806SS-0020	806SS-0030	806SS-0050	806SS-0040
Max. range of radio (m)	30	30	30	30	30
Max range of infrared beam (m)	10 (TX - RX)	-	-	-	-

## Technical characteristics

MODELS	806SS-0010	806SS-0020	806SS-0030	806SS-0050	806SS-0040
Protection rating (IP)	54	54	54	55	-
Power supply (V)	3	3	3	24 AC - DC	5
Radio signal frequency (Mhz)	868,95	868,95	868,95	868,95	868,95
Battery type	2 CR123A Lithium	1 CR123A Lithium	2 CR123A Lithium	-	-
Battery capacity (mAh)	1700	1700	1700	-	-
Operating temperature (°C)	-20 ÷ +55	-20 ÷ +55	-20 ÷ +55	-20 ÷ +55	-20 ÷ +55
Material	ABS – Polycarbonate	ABS – Polycarbonate	ABS – Polycarbonate	ABS – Polycarbonate	-

Code	Description
<b>Wireless, infrared beam photocells.</b>	
<b>806SS-0010</b> 	RIOPH8WS - Pair of wireless, infrared-beam photocells. Infrared range: 10 (m)
<b>Wireless modules</b>	
<b>806SS-0020</b> 	RIOED8WS - Wireless module for controlling resistive sensitive safety-edges.
<b>Wireless flashing lights</b>	
<b>806SS-0030</b> 	RIOLX8WS - Wireless flashing light
<b>Surface-mounted wireless control modules</b>	
<b>806SS-0050</b> 	RIOCT8WS - External radio-control module for managing wireless accessories.
<b>Wireless plug-in control modules for operators set up for RIO System 2.0 technology</b>	
<b>806SS-0040</b> 	RIOCN8WS - Snap-in, radio-based control module for managing wireless accessories.
<b>Accessories for: 806SS-0010</b>	
001 <b>DB-L</b>	Anodized aluminum with natural finish post. H = 500 mm.
001 <b>DB-LN</b>	Black anodized aluminum post. H = 500 mm.
001 <b>DB-CG</b>	Silver RAL9006, PVC post. H = 500 mm.
<b>Accessories for: 806SS-0030</b>	
001 <b>KIAROS</b>	Wall-fastening base.



# Quick&Easy Access

CAME Connect access



## The perfect solution for temporary access management.

- Developed with CONNECT technology for remote management of temporary access via gateway
- Benefits to the system operator:
  - > Check IN and Check OUT management
  - > Automated system for access via smartphone
  - > Keypad code management via cloud for opening doors in common areas or for unconnected guests
  - > Scheduling
  - > Customizable invitation mail with logo and facility information
  - > Customizable confirmation in various languages
- Benefits for visitors or guests:
  - > No registration process required
  - > No app to install, just web browser
  - > Unlimited access at any time
  - > Secure management of personal data
- Extension of access management to CAME automations.
- Freedom of installation by choosing the appropriate connection type (Wi-Fi-Ethernet-GSM).

### Dimensions (mm)

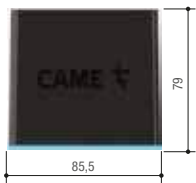

806SA-0180

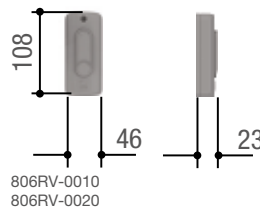

806RV-0010  
806RV-0020

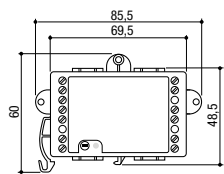

806SA-0170

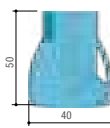

806SA-0150





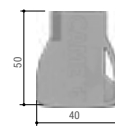













806SA-0200



### Technical characteristics

MODELS	806SA-0180	806RV-0020	806SL-0280
Protection rating (IP)	30	65	54
Power supply (V)	5 DC	120 - 230 V AC	12 - 24 AC - DC
Radio signal frequency (Mhz)	869,50	433,92 - 868,35	-
Power (W)	-	-	0.35
Operating temperature (°C)	+5 ÷ +40	-20° ÷ 55°C	-20 ÷ +55

● 24 V DC

Code	Description
<b>Access control kit</b>	
<b>8K06RV-005</b>  	Quick&Easy Access - Temporary access management kit consisting of gateway 806SA-0180, RBE 806RV-0020, a wired keypad 806SL-0280, a keypad encoder board 001R800 and a slave module 806SA-0150.
<b>8K06RV-006</b>  	Quick&Easy Access WiFi - WiFi kit for the management of temporary access composed of a WiFi gateway (806SA-0200), RBE4230 (806RV-0020), a wired keypad (806SL-0280) and a keypad coding card (001R800).
<b>AC Gateways</b>	
<b>806SA-0180</b>  	QBEMFSAC - Ethernet-Wi-Fi gateway to control access, with the CAME Connect system, up to 5 slave modules via radio link.
<b>806SA-0170</b>   	RGSM001AC - GSM Gateway module with built-in radio, for remote control of accesses with the CAME CONNECT dedicated system (002RSE module included). For controlling up to five slave modules.
<b>806SA-0200</b>  	Wi-Fi Gateway AC to control access with the CAME Connect system.
<b>Slave modules</b>	
<b>806SA-0150</b> 	Slave Module to connect the operator to the CAME Connect gateways.
<b>806SA-0040</b>  	RSLV001 - Slave module for operators (002RSE module included).
<b>Receiver modules</b>	
001 <b>AF43S</b>	433,92 MHz plug-in radio frequency card.
001 <b>AF868</b>	868.35 MHz plug-in radio frequency card.
<b>12 - 24 V AC - DC external modules</b>	
<b>806RV-0010</b>  	RBE4024 - Four-channel surface-mounted multi-user IP54 receiver module, 24 V AC - DC to store up to 3000 different users (codes), for TOP, TAM, ATOMO D, TWIN and TTS coding.
<b>120 - 230 V AC external modules</b>	
<b>806RV-0020</b> 	RBE4230 - Four-channel surface-mounted multi-user IP54 receiver module, 120 - 230 V AC to store up to 3000 different users (codes), for TOP, TAM, ATOMO D, TWIN and TTS coding.









## DOWNLOAD THE CAME AUTOMATION APP

The Cloud connection changes the way we experience our automated operators, by ensuring comfort and safety. We have put all our CAME Connect automated products online. In this way they can be controlled from any smartphone or tablet.



# THE COMPLETE RANGE

Code	Description
<b>Accessories for keypad operation</b>	
001 <b>R800</b>	Control board for decoding and access-control management via keypad selectors.
<b>806SL-0280</b> 	SELT1BDG - Surface-mounted 12-key BUS CXN keypad selector with blue backlighting. RAL7024 gray color.
<b>806SL-0290</b> 	SELT2BDG - Recess-mounted 12-key BUS CXN keypad selector with blue backlighting. RAL7024 gray color.
<b>Accessories for operation with Manchester transponders</b>	
001 <b>R700</b>	Control board for decoding and access-control management via transponder selector.
<b>806SL-0300</b> 	SELR1BDG - Surface-mounted BUS CXN transponder selector for cards, keyfobs and TAG (Manchester protocol) with blue backlighting. RAL7024 gray color.
<b>806SL-0310</b> 	SELR2BDG - Recess-mounted BUS CXN transponder selector for cards, keyfobs and TAG (Manchester protocol) with blue backlighting. RAL7024 gray color.
009 <b>PCT</b>	Keyfob transponder.
<b>806XG-0090</b>	Transponder card, ISO 7810 - 7813 format, Manchester 125 KHz protocol.
<b>Accessories for operation with MIFARE transponders</b>	
001 <b>R700</b>	Control board for decoding and access-control management via transponder selector.
<b>806SL-0320</b> 	SELM1BDG - Surface-mounted BUS transponder selector for MIFARE cards with blue backlighting. RAL7024, gray color.
<b>806SL-0330</b> 	SELM2BDG - Recess-mounted BUS transponder selector for MIFARE cards with blue backlighting. RAL7024, gray color.
<b>806XG-0100</b>	ISO MIFARE Classic 1 K – 13.56 MHz card.



## DOWNLOAD THE CAME AUTOMATION APP

The Cloud connection changes the way we experience our automated operators, by ensuring comfort and safety. We have put all our CAME Connect automated products online. In this way they can be controlled from any smartphone or tablet.



## WI-FI TECHNOLOGY SETUP EXAMPLE



## GSM TECHNOLOGY SETUP EXAMPLE

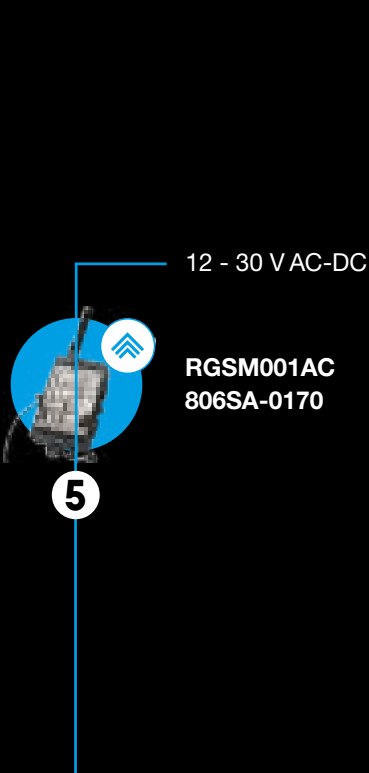

## GATEWAY TECHNOLOGY WITH QBE SETUP EXAMPLE

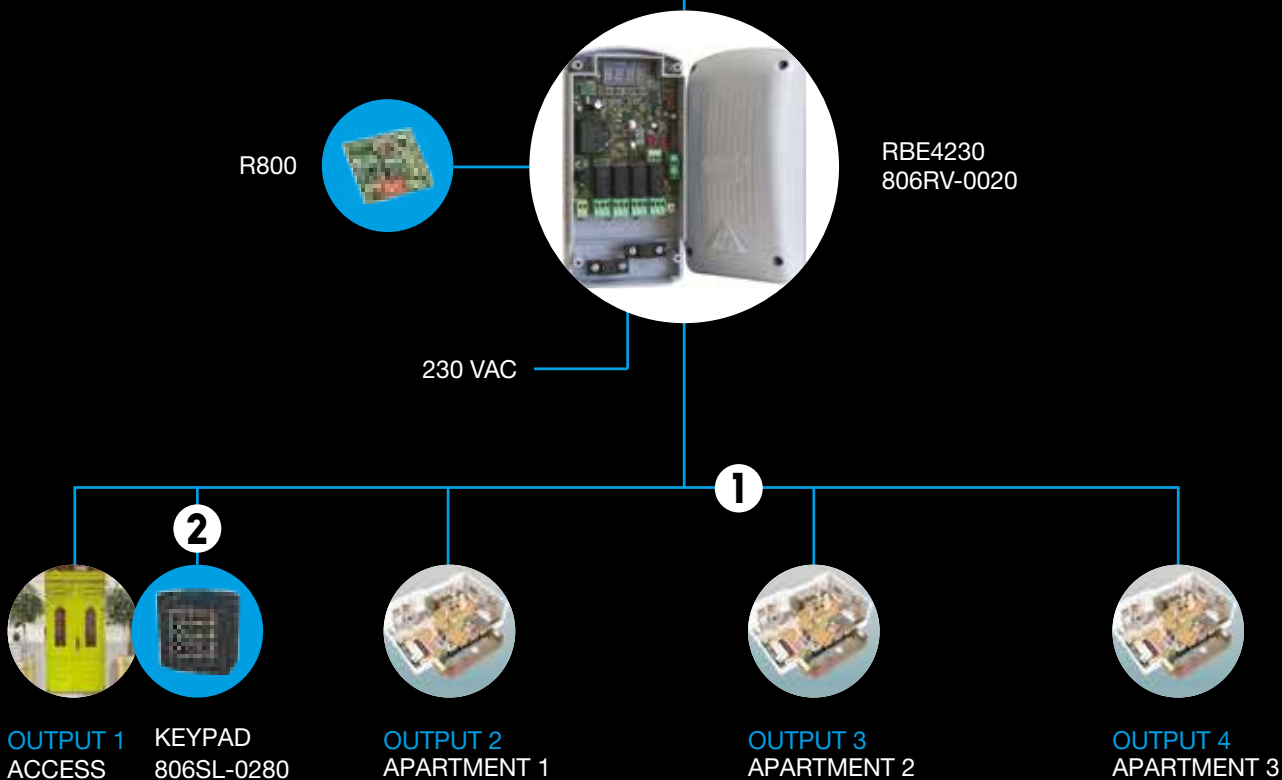

**1** Connect door locks to RBE (wired up to 4 doors)

**2** Connect keypad to RBE (wired up to 4 keypads)

**3** Plug the radio slave module into the RBE socket

**4** Plug the Wi-Fi gateway into the RBE socket

**5** Connect radio slave module to QBE or RGSM (up to 5 slave module)

**6** Set up QBE with your home Internet network (via Wi-Fi or cable)

# Analytical index

Page.	Code	Page.	Code	Page.	Code
001A3000	87	001E787A	127	001KR312S	89
001A3000A	87	001EM4001	127	001KR510D	89
001A3024N	87	001EM4024	127	001KR510S	89
001A4364	106	001EM4024CB	127	001KR512D	89
001A4365	106	001F4004	191	001KR512S	89
001A4370	106	001F40230E	191	001LBF70	100
001A4801	109	001F4024E	191	001LOCK81	78
001A5000	87	001F4024EP	191	001LOCK82	78
001A5000A	87	001FA70230	99	001PSRT01	152
001A5024N	87	001FA70230CB	99	001R001	55
001AF43S	213	001FA7024	99	001R700	52
001AF43SR	213	001FA7024CB	99	001R800	49
001AF43TW	213	001FE40230	103	001RE432M	213
001AF868	213	001FE40230V	103	001RE862M	213
001AF86SR	213	001FE4024	103	001RGP1	49
001ARK1	177	001FE4024V	103	001RSDN001	52
001ARK2	177	001FERNI-BDX	103	001RSDN002	52
001AX302304	85	001FERNI-BSX	103	001RSDN003	52
001AX3024	85	001FL-180	106	001RSWN001	81
001AX312304	85	001FROG-A	105	001STYLO-BD	91
001AX402306	85	001FROG-A24	105	001STYLO-BS	91
001AX412306	85	001FROG-A24E	105	001STYLO-ME	91
001AX5024	85	001FROG-AE	105	001STYLO-RME	91
001AX71230	85	001FROG-AV	105	001TMF6W	243
001B4337	55	001FROG-CD	111	001TMF6WN	243
001B4353	58	001FROG-CFN	106	001TMFW	243
001BY-3500T	65	001FROG-CFNI	106	001TMFWN	243
001C002	191	001FROG-CS	111	001TOP-A433N	213
001C003	195	001FROG-MD	111	001TOP-A862N	213
001C004	195	001FROG-MS	111	001TOP-RG58	213
001C005	195	001FROG-PC	109	001UNIP	177
001C006	195	001FROG-PM4	109	001V005	123
001C007	195	001FROG-PM6	109	001V06001	125
001C008	195	001G0121	175	001V06002	125
001C009	195	001G02040	157	001V06003	125
001C011	195	001G02802	141	001V06005	125
001CAT-15	179	001G02807	142	001V06006	125
001CAT-5	179	001G02809	147	001V06007	125
001C-BX	193	001G0401	141	001V0679	123
001C-BXK	193	001G0402	141	001V0682	123
001C-BXT	194	001G0403	142	001V0683	123
001CMS	191	001G04060	157	001V0684	123
001CSS	231	001G0460	165	001V0685	123
001CSSN	231	001G04601	161	001V0686	123
001D001	87	001G0461	142	001V0687	123
001DB-CG	249	001G0465	161	001V0688	123
001DB-L	249	001G0468	161	001V121	123
001DB-LN	249	001G0502	161	001V201	123
001DELTA-B	221	001G05350	161	002LB22	177
001DELTA-BN	221	001G0601	165	002LB38	175
001DFWN1500	243	001G0602	163	002LB39	161
001DFWN1500N	243	001G0603	165	002LBEM40	127
001DFWN1700	243	001G0605	165	002RLB	49
001DFWN1700N	243	001G06080	157	002RSE	52
001DFWN2000	243	001G06850	163	002ZA3P	77
001DFWN2000N	243	001G12000K	175	002ZL60	81
001DFWN2500	243	001G1325	175	002ZL65	77
001DFWN2500N	243	001G5000	161	002ZM3E	77
001DIR10	223	001G6000	165	002ZM3EC	191
001DIR20	223	001G6001	165	002ZM3EP	109
001DIR30	223	001G6500	163	002ZM3ES	111
001DIR-CG	219	001G6501	163	002ZT6N	57
001DIR-CGP	219	001H001	197	002ZT6NC	57
001DIR-L	219	001H3000	52	009CCT	55
001DIR-LN	219	001H3001	197	009CGIU	55
001DIR-P	219	001H40230120	197	009CGZ	49
001DIR-PN	219	001H40230180	197	009CGZ6	58
001DIR-S	219	001H41230120	197	009CGZP	49
001DIRZ	223	001H41230180	197	009CGZS	49
001DOC-L	221	001KIAROS	229	009DOC-S	221
001DOC-LN	221	001KLED	229	009PCT	233
001DOC-R	221	001KLED24	229	009RV117H	243
001E001	127	001KR001	89	009RV118A	243
001E002	127	001KR300D	89	009RV118I	243
001E781A	127	001KR300S	89	009RV118M	243
001E782A	127	001KR302D	89	009RV118N	243
001E783	127	001KR302S	89	009SMA	142
001E784	127	001KR310D	89	009SMA2	142
001E785A	127	001KR310S	89	009SMA220	235
001E786A	127	001KR312D	89	801MB-0050	93

Page.	Code	Page.	Code	Page.	Code
801MB-0080	93	803BC-0060	179	806SA-0100	158
801MB-0090	99	803XA-0020	147	806SA-0120	62
801MB-0100	99	803XA-0050	146	806SA-0130	241
801MB-0130	95	803XA-0051	146	806SA-0140	227
801MB-0140	95	803XA-0140	157	806SA-0150	227
801MB-0150	95	803XA-0150	147	806SA-0170	251
801MB-0160	95	803XA-0160	147	806SA-0180	251
801MP-0020	81	803XA-0180	158	806SA-0200	251
801MP-0030	83	803XA-0190	147	806SL-0010	231
801MP-0040	83	803XA-0200	157	806SL-0020	231
801MP-0050	77	803XA-0230	153	806SL-0030	231
801MP-0060	77	803XA-0240	164	806SL-0040	231
801MP-0070	77	803XA-0250	170	806SL-0050	231
801MP-0080	77	803XA-0260	157	806SL-0051	231
801MP-0090	77	803XA-0270	152	806SL-0060	231
801MP-0100	77	803XA-0280	152	806SL-0061	231
801MP-0110	77	803XA-0290	142	806SL-0070	231
801MS-0020	55	803XA-0300	141	806SL-0080	231
801MS-0030	55	803XA-0310	153	806SL-0090	231
801MS-0070	57	803XA-0320	153	806SL-0100	231
801MS-0080	57	803XA-0330	142	806SL-0170	233
801MS-0090	57	803XA-0340	142	806SL-0180	233
801MS-0100	57	803XA-0350	153	806SL-0260	234
801MS-0120	57	803XA-0360	153	806SL-0270	234
801MS-0130	57	803XA-0370	172	806SL-0280	233
801MS-0140	49	803XA-0380	170	806SL-0290	233
801MS-0150	51	803XA-0390	171	806SL-0300	233
801MS-0160	51	803XA-0400	170	806SL-0310	233
801MS-0180	51	803XA-0410	170	806SL-0320	233
801MS-0190	51	803XA-0420	170	806SL-0330	233
801MS-0210	51	803XA-0430	170	806SL-0340	234
801MS-0230	51	803XA-0440	142	806SL-0350	234
801MS-0250	51	803XA-0450	153	806SL-0360	234
801MS-0300	61	803XA-0560	147	806SL-0370	235
801MS-0310	61	803XA-0570	147	806SS-0010	249
801MS-0320	61	803XA-0580	142	806SS-0020	249
801MS-0350	61	803XA-0590	142	806SS-0030	249
801MS-0360	61	803XA-0620	158	806SS-0040	249
801MS-0370	61	803XA-0630	141	806SS-0050	249
801MS-0520	61	803XA-0640	152	806SS-0060	243
801MS-0570	51	803XC-0010	161	806TF-0030	219
801MS-0580	51	803XC-0020	141	806TF-0040	219
801MS-0590	51	806ED-0130	245	806TF-0050	219
801MV-0010	123	806ED-0131	245	806TF-0060	219
801MV-0020	123	806ED-0132	245	806TF-0070	221
801MV-0050	125	806ED-0133	245	806TF-0080	221
801MV-0060	125	806ED-0140	245	806TF-0090	221
801QA-0030	177	806ED-0141	245	806TF-0100	221
801QA-0050	77	806ED-0142	245	806TF-0110	219
801QA-0060	77	806ED-0143	245	806TF-0120	219
801QA-0140	193	806ED-0150	245	806TS-0230	213
801QA-0150	193	806ED-0151	245	806TS-0240	213
801XA-0030	106	806ED-0152	245	806TS-0250	213
801XC-0010	123	806ED-0153	245	806TS-0270	215
801XC-0070	93	806ED-0160	246	806TS-0290	215
801XC-0100	55	806ED-0161	246	806TS-0300	215
801XC-0110	177	806ED-0162	246	806TS-0310	215
801XC-0120	62	806ED-0163	246	806TS-0330	215
801XC-0130	62	806ED-0164	246	806XG-0020	213
801XC-0150	195	806ED-0165	246	806XG-0030	142
803BB-0120	157	806ED-0166	246	806XG-0040	142
803BB-0160	151	806ED-0167	246	806XG-0050	142
803BB-0180	169	806ED-0168	246	806XG-0060	195
803BB-0240	151	806ED-0169	246	806XG-0070	195
803BB-0250	169	806ED-0170	246	806XG-0080	52
803BB-0260	151	806ED-0171	246	806XG-0090	233
803BB-0270	169	806ED-0171	246	806XG-0100	233
803BB-0280	151	806LA-0010	227	809QA-0010	197
803BB-0290	169	806LA-0020	227	818XG-0019	142
803BB-0370	141	806LA-0030	227	842EC-0020	241
803BB-0390	141	806LA-0040	227	8K06RV-005	251
803BB-0400	141	806LA-0050	227	8K06RV-006	251
803BB-0410	145	806LA-0060	225	8K06SL-004	231
803BB-0430	145	806LA-0070	227	8K06SL-005	231
803BB-0440	145	806RV-0010	213	8K06SL-006	233
803BC-0010	179	806RV-0020	213	8K06SL-007	233
803BC-0020	179	806SA-0010	241	8K06SL-008	233
803BC-0030	179	806SA-0020	241	8K06SL-009	233
803BC-0040	179	806SA-0040	241		
803BC-0050	179	806SA-0050	241		
		806SA-0090	62		

**CAME** 



## CORPORATE HEADQUARTERS

**CAME S.p.A.**  
Via Martiri della Libertà, 15  
31030 Dossone di Casier  
Treviso - ITALY

## MANUFACTURING COMPANIES

**CAME PARKARE GROUP S.L.**  
Barcelona, SPAIN

**NEPOS SISTEMAS DE CONTROLE E AUTOMAÇÃO EM ESTACIONAMENTO E TRÁFEGO LTDA**  
São Paulo, BRAZIL

**ÖZAK GEÇİŞ TEKNOLOJILERI SAN. TIC. A.Ş.**  
Kocaeli, TÜRKIYE

## COMMERCIAL BRANCHES EUROPE

**ITALY**  
CAME ITALIA S.r.l.  
Treviso

**BELGIUM**  
CAME BENELUX S.A.  
Lessines

**CROATIA**  
CAME ADRIATIC d.o.o.  
Kastav

**FRANCE**  
CAME FRANCE S.A.S.  
Paris

**GERMANY**  
CAME DEUTSCHLAND GmbH  
Stuttgart

**IRELAND**  
CAME BPT IRELAND LIMITED  
Dublin

**THE NETHERLANDS**  
CAME NEDERLAND B.V.  
Breda

**POLAND**  
CAME POLAND Sp. z o.o.  
Warszawa

**PORTUGAL**  
CAME PORTUGAL,  
UNIPESSOAL, LDA  
Lisbon

**RUSSIA**  
UMC RUS LLC  
Moscow

**SPAIN**  
CAME SPAIN S.A.  
Madrid

**THE UNITED KINGDOM**  
CAME UK LIMITED  
Nottingham

## COMMERCIAL BRANCHES ASIA

**U.A.E.**  
CAME GULF FZCO  
Dubai

**CINA**  
CAME AUTOMATION SYSTEM CO  
Shanghai

## COMMERCIAL BRANCHES AMERICAS

**BRAZIL**  
CAME DO BRASIL, INDÚSTRIA,  
IMPORTAÇÃO, EXPORTAÇÃO,  
COMÉRCIO E SERVIÇOS DE  
AUTOMAÇÃO LTDA  
São Paulo

**MEXICO**  
CAME AUTOMATISMOS §  
DE MEXICO S. DE R.L. DE C.V.  
Mexico City

**PERÚ**  
CAME PARKARE PERU S.A.C.  
Lima

**USA**  
CAME AMERICAS AUTOMATION LLC  
Miami, FL

**CANADA**  
CAME CANADA Inc.  
Toronto



© CAME SPA - KACENAU024 - 2024 - EN EXPORT  
CAME RESERVES THE RIGHT TO MAKE ANY CHANGES TO THIS DOCUMENT AT ANY TIME.  
YOU MAY NOT EVEN PARTIALLY REPRODUCE THIS DOCUMENT.



**CAME S.p.A.**  
has the following Quality, Environmental  
and Safety certifications:  
ISO 9001  
ISO 14001  
ISO 45001

**CAME**



Official Sponsor of

**aprilia**  
RACING