

MULTI WAY AUDIO AND VIDEO DOOR ENTRY KITS

2 WAY AUDIO DOOR ENTRY KIT



INSTALLATION GUIDE

bticino

A brand of **legrand**

■ If you require assistance, please contact our technical support helpline on **0370 608 9020** or email **dooreentry.uk.technical@legrand.com**

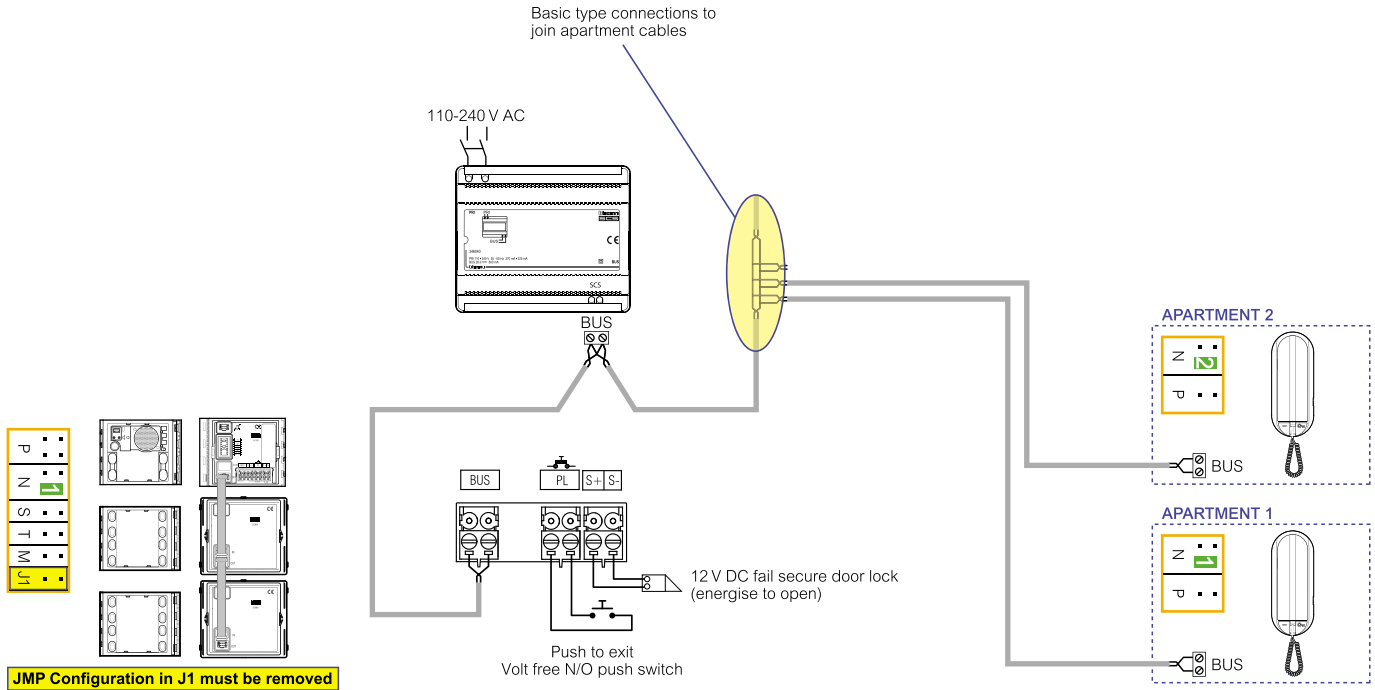

■ We recommend Bticino cable Cat. No. **3369 04**, see guidance notes for usage of different cable types
 BUS cable connections are non polarised meaning the cable cores can be terminated in either connection terminal

ALL CONFIGURATION SHOULD BE DONE WHILE THE SYSTEM IS POWERED OFF!

ENTRANCE PANEL CONFIGURATION

Mic/Speaker adjustment
Orange adjustment tool provided
with speaker module

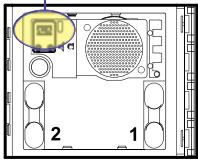

Push button layout

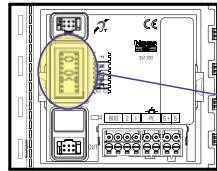

Configuration should match the image for this system

EXAMPLE HANDSET CONFIGURATION

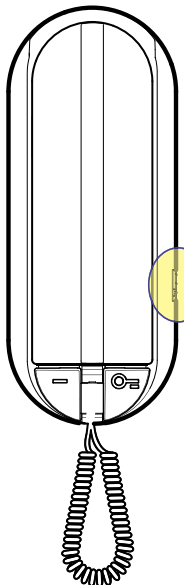

Internal unit
Ringer volume

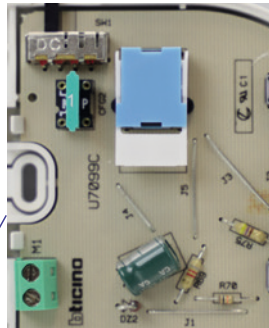

Apartment 1
Configuration 1

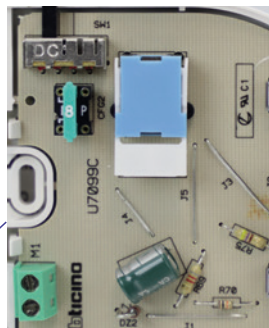

Apartment 8
Configuration 8

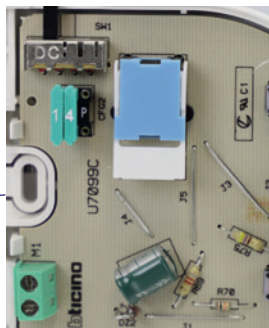

Apartment 14
Configuration 14



■ If you require assistance, please contact our technical support helpline on **0370 608 9020** or email **dooreentry.uk.technical@legrand.com**

DOOR LOCK WIRING EXAMPLES

EXAMPLE 1 - Fail secure door dock (energise to open)

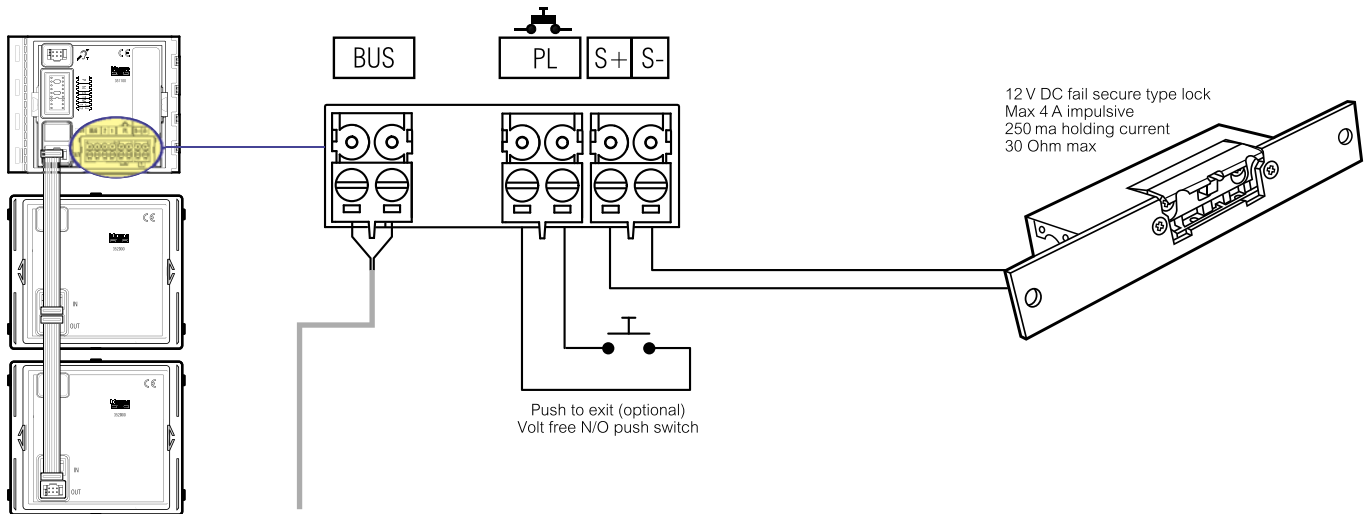

EXAMPLE 2 - Fail safe door dock (de-energise to open)

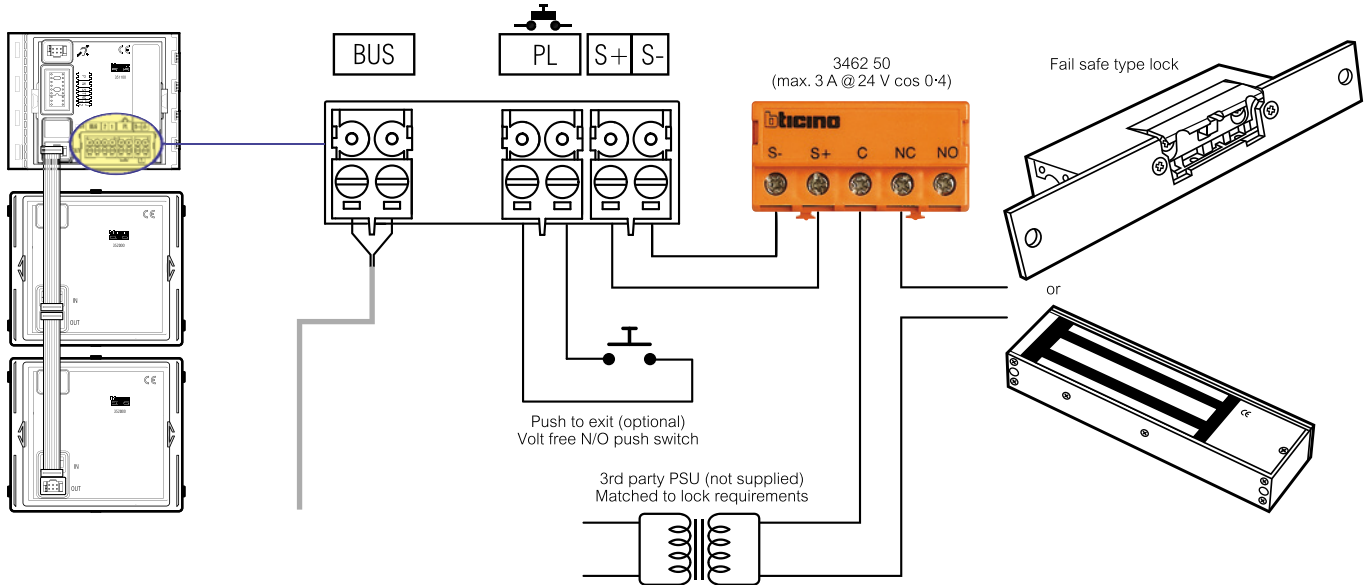

EXAMPLE 3 - Motorised gates / 3rd party proximity

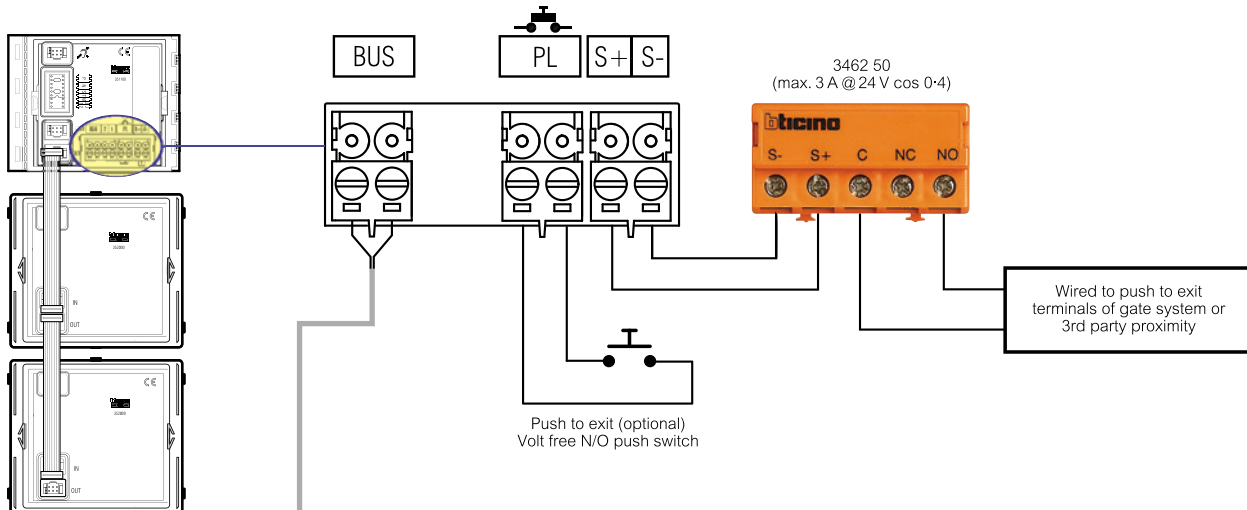

■ If you require assistance, please contact our technical support helpline on **0370 608 9020** or email **dooreentry.uk.technical@legrand.com**

ENTRANCE PANEL MOUNTING AND CABLING GUIDELINES

BACKBOX SIZES

Surface mounting backboxes with in-built rainshields

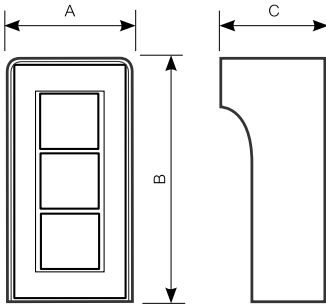

Dimensions (mm)			
Cat. Nos.	A	B	C
BT4WAKIT	151	151	82
BT4WVKIT BT6WVKIT BT6WAKIT BT8WVKIT BT8WAKIT BT10WVKIT BT10WAKIT BT12WAKIT	151	242	82
BT12WVKIT BT14WVKIT BT14WAKIT BT16WVKIT BT16WAKIT BT18WVKIT BT18WAKIT	151	334	82

■ If you require assistance, please contact our technical support helpline on **0370 608 9020** or email dooreentry.uk.technical@legrand.com

CABLING GUIDELINES MOST COMMON CABLES

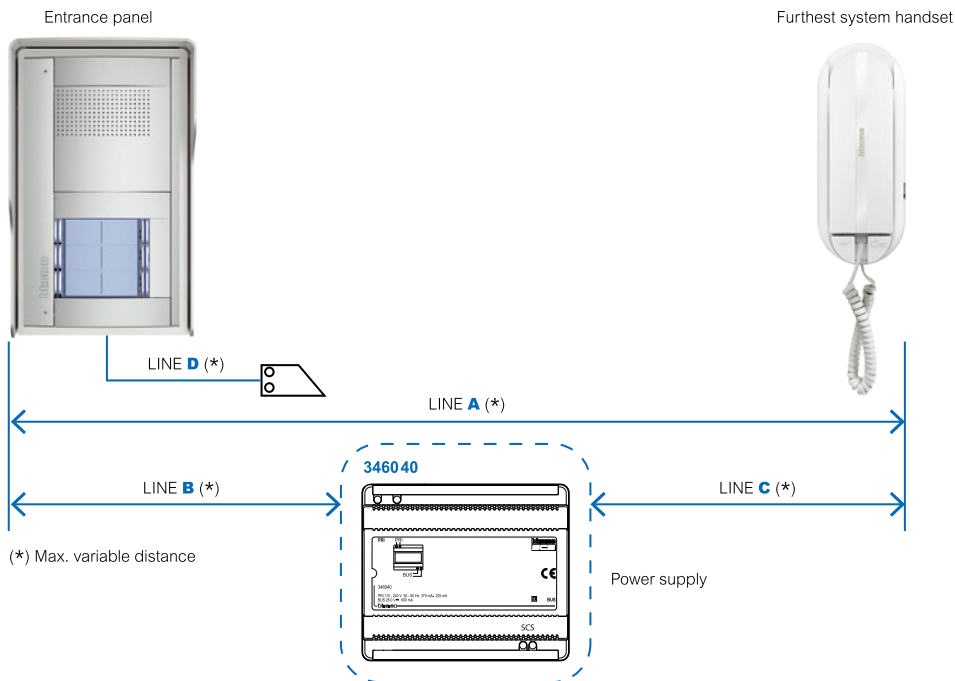

LINE max. distance	2 core untwisted 0-2 mm	Cat 5 single twisted pair	Telephone single twisted pair 0-28 mm	Bticino 3369 04/3369 05
A	50 m	125 m	125 m	200 m
B	50 m	70 m	70 m	150 m
C	50 m	75 m	75 m	170 m
D	10 m	30 m	30 m	50 m

■ Recommended cable **3369 04/3369 05** for best performance
We cannot guarantee the performance of 3rd party cable suppliers

OPTIONAL ADVANCED SETTINGS AND FEATURES

DOOR LOCK TIMING (T configuration)

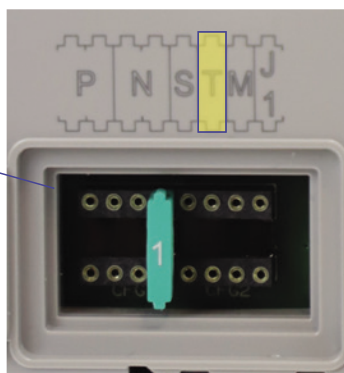
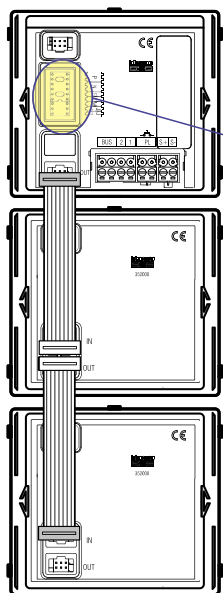

Jumpers in slots J1 and may vary depending on kit used, please see p. 3 for required configuration details

As default, the speaker module without a configurator in the "T" slot will allow the door lock to operate for 4 seconds, if a different door lock operation time is desired, you can change the door lock timing to match the table below (additional purchase of configurators may be required)

Configurator Number						
0 (no configurator)	1	2	3	5	6	7
4 sec	1 sec	2 sec	3 sec	6 sec	8 sec	10 sec

For door lock times greater than 10 seconds and/or different lock requirements please contact our technical support team who would be more than happy to assist

TROUBLESHOOTING

System does not power up

- Check the incoming supply of the power supply is 230 V
- Check the BUS voltage on BUS terminals of all devices is 26 V DC
- Check for loose connections on the system

System powers up but does not call correctly

- Check the BUS is 26 V DC at every point, including entrance panel and internal handsets and make sure that the BUS is wired to the correct terminals on each device
- Check entrance panel and handset configurators are correct, please see the configuration guide on p. 3
- Reset the power to the system. The configuration must be done with the system powered off as the configuration only gets read into the system when it is powered up
- Check you are pressing the correct call button, please see the call button positions on p. 3 which shows the configuration positions of the call buttons
- Check the JMP configurator is correct in the J1 slot of the entrance panel as shown on p. 2 and 3, once this has been changed a power reset must be performed to read in the new configuration
- If the handset is not calling, check the ringer volume settings on the right-hand side of the internal unit to make sure the ringer volume is at a suitable level, see p. 3

Door lock is not working correctly

- Check that 12-18 V DC is on terminals S+ and S- of the entrance panel whilst the door lock button on the handsets is being pressed
- Check the door lock wiring is correct for the type of door lock you have, see p. 4
- Check the push to exit button (if installed) is a sprung return N/O push switch

System has interference

- Low voltage cabling should not be run with mains equipment, check the wiring runs are not being run along with power cables anywhere on the system

Audio low / squealing

- If you hear squealing at the entrance panel during conversation (Larson effect) this could be due to the mic and loudspeaker adjustments both being set too high causing the A/V module to self amplify. Fine tune the mic and speaker until squealing stops and the desired audio level is achieved. These can be found on the front of the A/V module and adjusted using the orange adjustment tool supplied with the A/V module, see p. 3
- Low speech audio can be rectified with fine tune adjustment to the mic and loudspeaker. The settings for these are located on the front of the A/V module of the entrance panel and can be changed using the orange adjustment tool supplied with the A/V module, see p. 3

■ If you require assistance, please contact our technical support helpline on **0370 608 9020** or email doentry.uk.technical@legrand.com

Contact details

United Kingdom

Great King Street North,
Birmingham, B19 2LF

Customer Services:

Tel: +44 (0) 345 605 4333

E-mail: legrand.sales@legrand.co.uk

Quotations and Technical Support:

Tel: +44 (0) 370 608 9020

E-mail: dooreentry.uk.technical@legrand.com

Republic of Ireland:

Tel: 01 295 9673

E-mail: legrand.sales@legrand.co.uk



**FOLLOW
US AT**

- @ www.legrand.co.uk
www.legrand.ie
-  www.youtube.com/legrandtvuk
-  www.twitter.com/legranduk
-  [www.linkedin.com/
company/legranduk](https://www.linkedin.com/company/legranduk)



Head office (UK and Ireland):

Legrand Electric Limited
Great King Street North, Birmingham, B19 2LF
Tel: +44 (0) 370 608 9000
Website: www.legrand.co.uk