

A1703

2-Wire Video Receiver

User manual

ATIGO

Contents

Video Receiver A1703	2
Parts & Functions	2
Mounting	3
Installation Setup	4
Address Setup (Master/Slave)	4
Auto Call Back	5
User Setup	5
Ringtone Volume	5
Ringtone Type	6
Operation	6
Status Setup (Do Not Disturb)	6
Accept Call	6
Monitor Door Station	7
Intercom Call	7
Restore Factory Settings	8
Precautions	8
Specifications	9

Video Receiver A1703

Parts & Functions

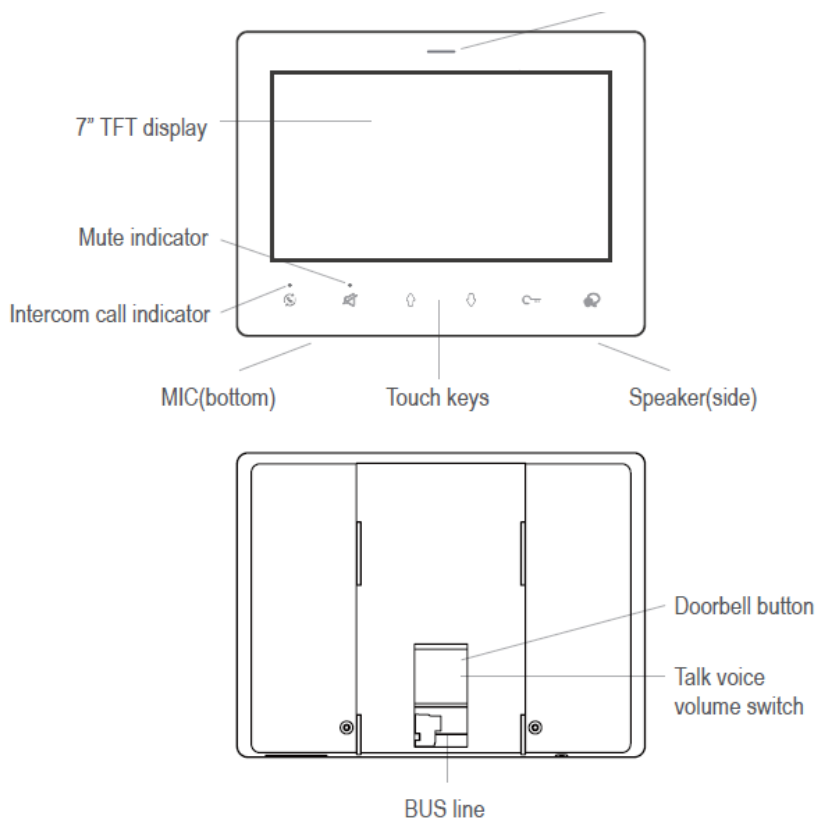

- Talk/Monitor
- Unlock
- Scroll up
- Scroll down
- Mute
- Intercom call

Talk voice volume switch: the volume of the speaker voice when talk with door station, up means high, down means low.

Mounting

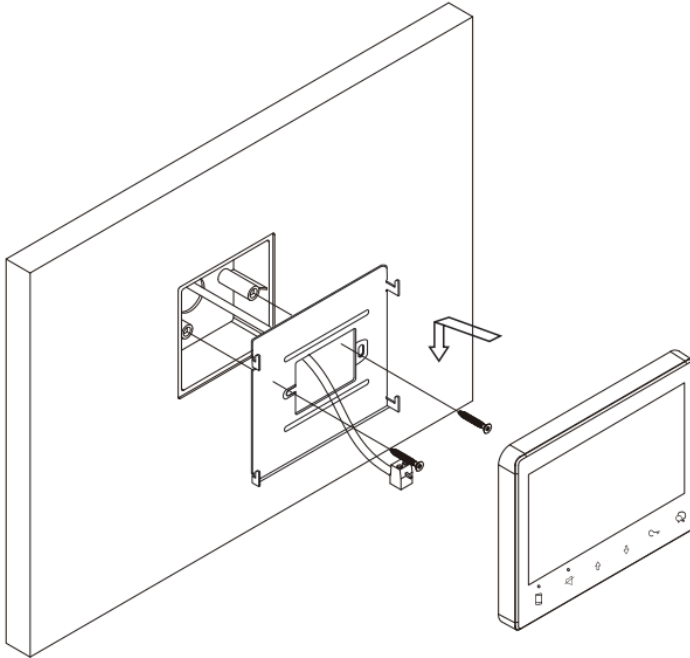



- A. Embed the mounting box into the wall.
- B. Use screws to fasten the mounting bracket to the mounting box.
- C. Connect the 2 wires cables to the unit.
- D. Mount the unit onto the mounting bracket.

The suggested installation height is between 145~160 cm from ground.

Installation Setup

Address Setup (Master/Slave)

By monitor menu:

- Tap ↓ or ↑ or C-⏏, to get into main menu
- In main menu, long press unlock key
- Tap ↑ (refers ) to set monitor address
- Tap ↓ (refers ) to set monitor master slave

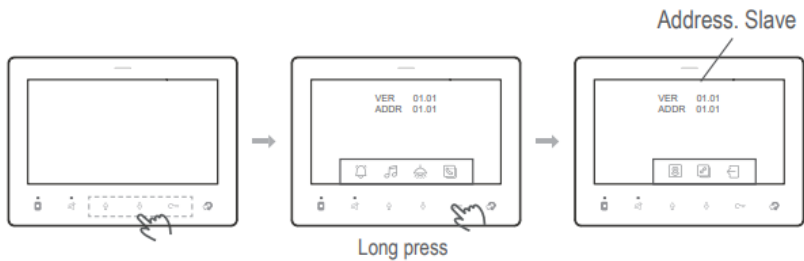

By door station call:

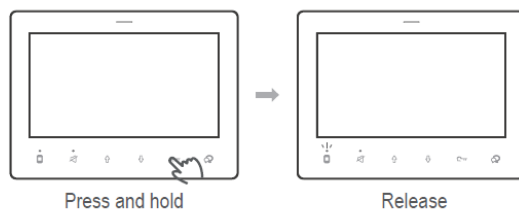

- When power up and standby (A1703 is screen off), press and hold C-⏏ for 6s until  led flashes.



- Call from door station with designed address, to activate the address..

Auto Call Back

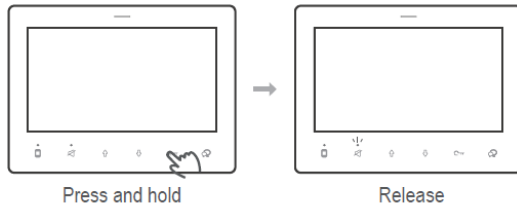

After 1 and 2 setups, A1703 can apply a calling from A1703, simulator a call from door station.

When power up and standby (A1703 is screen off), press and hold  for 3s until  lashes.





User Setup

Ringtone Volume

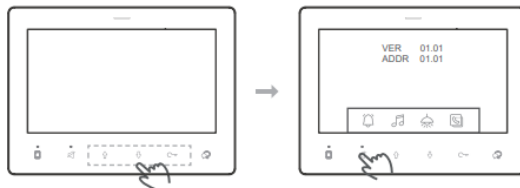
2 levels adjustable. When standby, into main menu, tap  refers  to switch the volume between large and small.



Ringtone Type

3 sets of the ring tune selectable. When standby, into main menu, tap  (refers ) to switch the melody between 3 sets, after switch A1703 will play the melody for door station calling, inner call, and ring button separately.

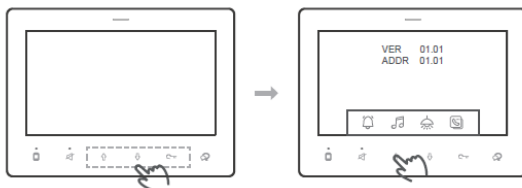

Operation

Status Setup (Do Not Disturb)

When power up and standby (A1703 is screen off), :



Tap  to enable "Do Not Disturb", the corresponding LED solid on mean the is in Do Not Disturb and will not ring for any calls.



Tap  to enable "Intercom call".

Accept Call



When A1703 rings,

Tap  to accept calling.

Tap  (refers ) to release door lock 1

Tap  (refers ) to release door lock2

Tap  (refers ) to adjust brightness of the image, 2 levels.

Tap  (refers ) to switch to other door station camera(if has)



Monitor Door Station

When power up and standby (A1703 is screen off), or in main menu, tap  to start monitoring door station 1.

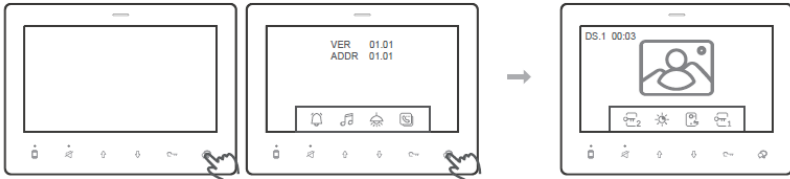



In monitoring check “Operation, point 2) for operations.

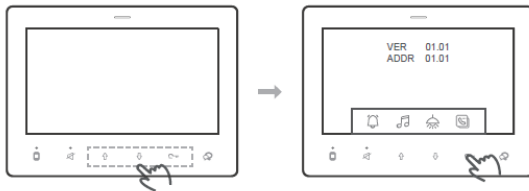

Intercom Call

When power up and standby (A1703 is screen off), into operate menu, tap  refer  to get into intercom/inner call menu.



And use  and  to scroll to the address needs to call and tap  to call, tap  again to end calling.



GU: to Guard Unit.

INNER: to monitor with the same address.

Restore Factory Settings

To restore to the factory default settings, by following steps.

1. Disconnect the A1703 from bus line, wait for 30s, and connect to bus line.
2. Within 10s power up, press and hold  for 12s, release when and LED flashes.
3. A long beep means all setting rest to factory default

Address will remain while the master/slave will restore

Precautions

1. All components should be protected from violence vibration. And not allow to be impacted, knocked and dropped.
2. Please do the cleanness with soft cotton cloth, please do not use the organic impregnant or chemical clean agent. If necessary, please use a little pure water or dilute soap water to clean the dust.
3. Image distortion may occur if the video monitor is mounted too close to magnetic field e. g. Microwaves, TV, computer etc.
4. Please keep away the monitor from wet, high temperature, dust, caustic and oxidation gas in order to avoid any unpredictable damage.
5. Must use the right adaptor which is supplied by the manufacturer or approved by the manufacturer.
6. Pay attention to the high voltage inside the products, please refer service only to a trained and qualified professional.

Specifications

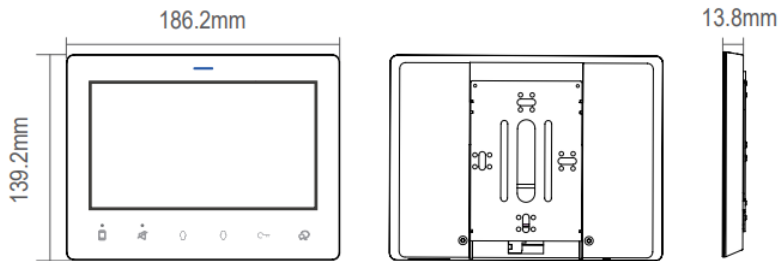

Power Supply: DC20 ~28 V

Power Consumption : standby 9mA,working 127mA

Working Temperature : -15°C ~ +55°C ;

Wiring: 2 wires, non-polarity

Monitor screen: 7 Inch digital color LCD