

CONGRATULATIONS ON PURCHASING THIS QUALITY PRODUCT!

Fermax electronics develops and manufactures systems of renown that meet the highest standards of design and technology. We hope you enjoy its range of functions.

Cod. 97666I, V11_11

Technical document published for information purposes by FERMAX ELECTRONICA.

FERMAX ELECTRONICA, in a policy of ongoing improvement, reserves the right to modify the contents of this document and the features of the products referred to herein at any time and with no prior notice. Any such modifications shall be reflected in subsequent editions of this document.

ENGLISH

INDEX

Introduction 4

Operating Status 5

1. Not Set-Up 5

2. Standby 5

3. Programming 5

 Add Users 7

 - a) Fingerprint Mode (1 finger)..... 7

 - b) Fingerprint Mode (2 fingers) 8

 - c) 1 fingerprint + Proximity/Code Mode 10

 - d) 2 fingerprints + Proximity/Code Mode 11

 - e) Only proximity or code mode..... 13

 Operation 14

 - 1 or 2 fingerprints mode 15

 - 1 or 2 fingerprints with proximity mode 15

 - 1 or 2 fingerprints with code mode 16

 - Proximity only 16

 - Code only 17

 Delete Users 17

 - Using their user number 17

 - FULL Reset of All Users 18

 Time Configuration 18

 - Lock-Release Timing 19

 - Door Sensor Timing 19

 Auxiliary Output Operation 20

 - No option activated 20

 - Door and door forced open alarm 20

 - Intruder Alarm 20

 Special finger options 20

 - Change master finger/card 21

 - Add a second master finger/card 21

 - Add a trade finger/card 22

 - Add an unblock finger/card 23

 - Add a security finger/card 24

 Operating Modes 25

 - Standard Mode 25

 - Security mode 25

 Network Identifier 26

 Copy 27

 Code length 28

 Centralised communication protocol 28

 Resetting the Master Code 28

Technical Characteristics 29

Wiring Diagram 30

Quick Programming Guide 30





Installation and Recommendations for Use and Maintenance 31

Installation or Replacement of the Battery in the Remote Keypad 32

PC Management 33

Operating Status

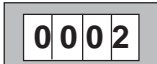
1. **Not Set-Up.** Default Status (as set in factory). A master fingerprint/card has not yet been registered.
2. **Standby.** Normal mode, waiting for registered users to use fingerprint identification. Where the user is recognised this will be indicated by way of an acoustic tone, a green light and the lock-release relay will also be activated.

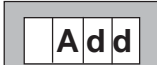

Standby mode Initial action	Data	Resulting action	Display/leds	Sound
			 RED GREEN	
Enter user card/ fingerprint	Registered	Lock-Release Opening	 indicates the register's memory position	beep Door Opening Time Period
	Not Registered	no action	 indicates an error	1 beep
Enter master fingerprint/card	Registered	Enter Programming Mode	 shows first programming option	1 beep

3. Programming.

In this mode the administrator can configure the system's different operating parameters.

It is accessed using the administrator's master fingerprint/card.

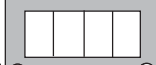
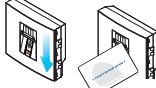
- a) Where a master fingerprint/card has not yet been registered (reader with default values).
- b) Master fingerprint/card registered on the reader.

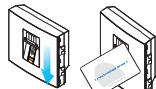
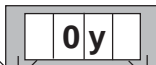
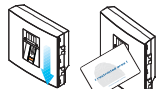
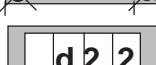
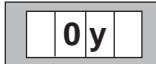
Initial action	Data	Resulting action	Display/leds	Sound 		
Enter master fingerprint/card	a) Not Registered (the reader will be registered for the first time with default factory values)	Register master fingerprint/ card	Mode Not Set-Up Once powered up Ini will appear on the display. - Enter the master fingerprint/card.			
					1 beep	
			- Confirm the master fingerprint/card			1 beep
					1 bip	
					1 beep	

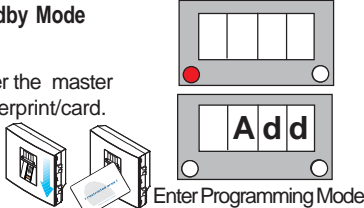
Initial action	Data	resulting action	Display/leds	Sound 
Enter master fingerprint/ card	b) Registered	Enter Programming Mode	<p>Standby Mode</p> <p>- Enter the master fingerprint/card.</p> 	1 beep



Led On



Led Off

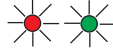

Led Flashing

The system is programmed with the Master fingerprint/card and a remote infrared keypad.

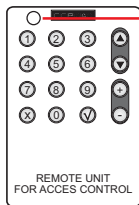

Led

The led lights up every time any of the keypad's keys are pressed.
Indications:

- Led Off. Does not transmit any signal.
- Red Led On. Correct Transmission.

Key Functions

This function can be used for:

- a) Data Entry
- b) Menu Selection

- Confirmation Key
- Cancel Key. Exit Programming Mode
- Scroll Keys in Menus
- Data Entry Keys

SUMMARY steps to enter/exit programming mode

Any time you wish to enter or exit Programming Mode you must follow these steps:

- **to Enter Mode: enter master fingerprint/card.**
- **to Exit Mode: press the cancel button (X).** The reader will automatically exit programming mode after 60 seconds of inactivity.

Add Users

To register new users. Every user has an associated "user number" from 0001 to maximum. The codes are stored in the memory in sequence: **user number - user fingerprint**.

Number of Users:

- * 4500 in 1 fingerprint per person mode.
- * 2970 in 2 fingerprint per person mode.

NOTE:

- It is very important **to compile a list** linking the user names and numbers (fingerprint recorded position) such that it will only be possible to delete a fingerprint if you know its associated position. The only other option is to delete ALL fingerprints on the reader, therefore we re-iterate the importance of compiling a list with aforementioned data.

Example of table:

Nº Usuario	Nombre Usuario
0001	Yaga Seelan
0002	Will Smith
0003	Tom Cruise
0004	Sarah Parker

The sequence for registering a user passes through all of the possible options consecutively:

- 1 fingerprint user mode
- 2 fingerprint user mode
- With proximity card or code

a) Add User in 1 Fingerprint Mode

Standby Mode



1. Enter the master fingerprint



1 beep

Enter Programming Mode

2. Confirm the Add option with the validation key



3. **d1.1** is shown. Enter the user fingerprint you wish to register in the system.

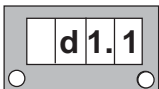

1 beep



1 beep

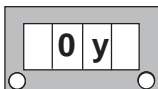

1 beep

4. **d1.2** is shown. Re-enter the user fingerprint you wish to register to confirm the fingerprint.

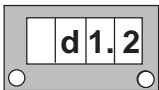

1 beep



1 beep

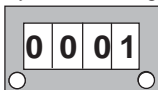

1 beep

5. **Relay** is shown. Using the scroll keys the following sequence will appear **relay, both, Au...**. There are three options the action of which associated with this user fingerprint is:

- **relay**: to open the door
- **both**: to open the door and activate the auxiliary exit simultaneously
- **Au**: to activate the auxiliary exit

Select the required option and confirm using the OK key

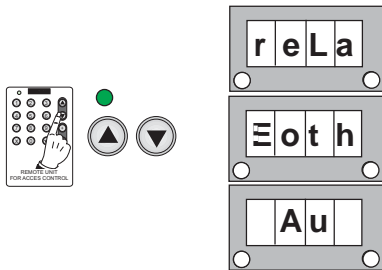

6. Cancel the rest of the options with "X" until the new option **d1.1** is shown, to continue registering users. Repeat the aforementioned steps to register new users in mode 1 fingerprint.

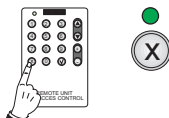

Details: If the reader is unable to read the user fingerprint an error message will appear and it will re-start.



NOTES:

- The same fingerprint cannot be entered twice on different registers (user number), therefore if it is already registered on the system it cannot be re-registered.
- The master fingerprint cannot be the user fingerprint either.

b) Add User in 2 Fingerprint Mode

Allows two fingerprints be registered for one user. The user can chose between the following second fingerprint functions:

- Allows the use of the second fingerprint where there is a problem with the first one (short-circuit, fire damageetc).
For this functionality choose the corresponding option: **relay** (to open the door).
- Intimidation Alarm. Using the second fingerprint instead of the first one the lock-release will activate as will the alarm output. Where the first fingerprint is used only the lock-release activates.
For this functionality choose the corresponding option: **Au** (to activate the auxiliary exit and the lock-release).

Standby Mode

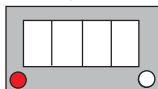

1. Enter the master fingerprint

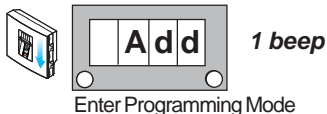

2. Confirm the Add option with the validation key

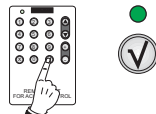

3. **d1.1** is shown. Enter the user fingerprint you wish to register in the system.



4. **d1.2** is shown. Re-enter the user fingerprint you wish to register to confirm the fingerprint.



5. **Relay** is shown. Using the scroll keys the following sequence will appear **relay**, **both**, **Au**... There are three options the action of which associated with this user fingerprint is:

- **Relay**: to open the door.
- **both**: to open the door and activate the auxiliary exit simultaneously.
- **Au**: to activate the auxiliary exit

Select the required option and confirm using the OK key.

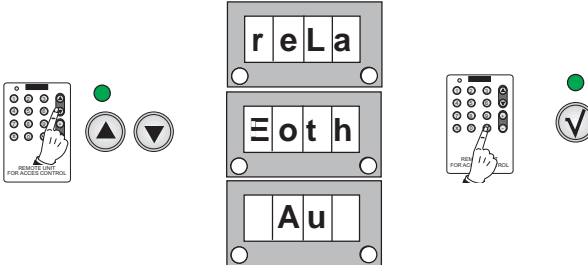

6. **d2** is shown. Confirm the second fingerprint option using the OK key Enter the user fingerprint you wish to use for the functions described in fingerprint mode 2.

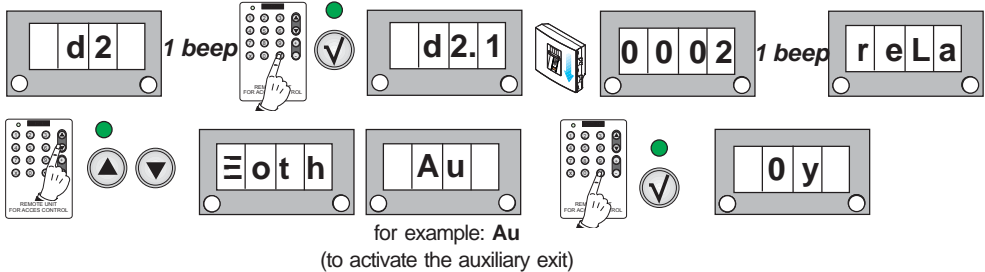

7. Cancel the rest of the options with **"X"** until the new option **d1.1** is shown, to continue registering users Repeat the aforementioned steps to register new users in mode 2 fingerprints.



Details: If the reader is unable to read the user fingerprint an error message will appear and it will re-start.



NOTES:

- The same fingerprint cannot be entered twice on different registers (user number), therefore if it is already registered on the system it cannot be re-registered.
- The master fingerprint cannot be the user fingerprint either.

c) Add user Mode 1 Fingerprint + Proximity or Code

Standby Mode

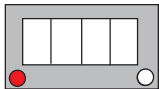

1. Enter the master fingerprint

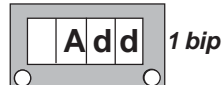

Enter Programming Mode

2. Confirm the Add option with the validation key

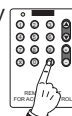

3. **d1.1** is shown. Enter the user fingerprint you wish to register in the system.

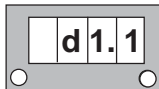

1 beep



1 beep

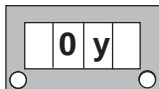

1 beep

4. **d1.2** is shown. Re-enter the user fingerprint you wish to register to confirm the fingerprint.

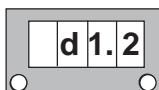

1 beep



1 beep



1 beep

5. **Relay** is shown. Using the scroll keys the following sequence will appear **relay, both, Au...** There are three options the action of which associated with this user fingerprint is:

- **Relay**: to open the door
- **both**: to open the door and activate the auxiliary exit simultaneously
- **Au**: to activate the auxiliary exit

Select the required option and confirm using the OK key.

Select an option

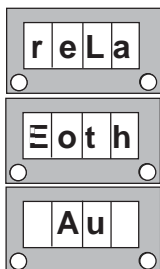

Accept

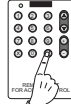

6. **d2** is shown. Cancel with "X". The reader is ready (LEDs flashing) for a card or code to be entered (if the reader has a keypad).



1 beep

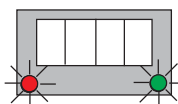
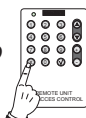

7. Bring close the card that you wish to register. If it has registered correctly **d1.1** is shown.

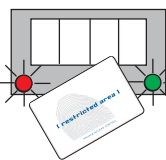

1 beep



1 beep

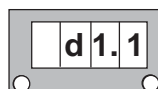

7b. If it was a keypad code (if the reader has a keypad).

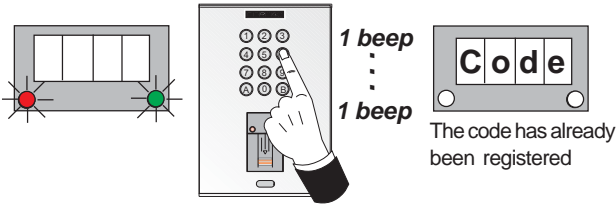

4 or 6 digit code + B. For example:

4 digits (1 2 3 4 + B)

6 digits (1 2 3 4 3 4 + B)

8. **d1.1 re-appears**, allowing us to continue registering users. Repeat the aforementioned steps to register new users in mode 1 fingerprint + keypad or code.

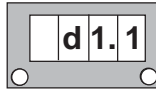

NOTE:

- The choice of number of digits (4 or 6) is chosen using the option: **Code**

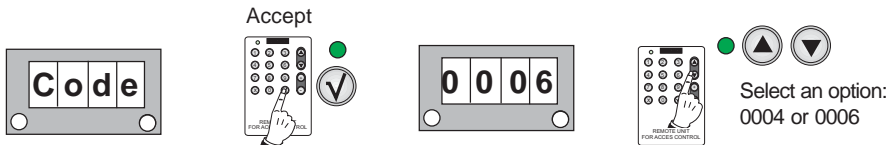

NOTES:

- The same fingerprint cannot be entered twice on different registers (user number), therefore if it is already registered on the system it cannot be re-registered.
- The master fingerprint cannot be the user fingerprint either.
- The same proximity card cannot be entered twice on different registers (user number), therefore if it is already registered on the system it cannot be re-registered.

d) Add user Mode 2 Fingerprints + Proximity or Code

Allows two fingerprints be registered for one user. The user can chose between the following second fingerprint functions:

- Allows the use of the second fingerprint where there is a problem with the first one (short-circuit, fire damageetc).
For this functionality choose the corresponding option: **relay** (to open the door).
- Intimidation Alarm. Using the second fingerprint instead of the first one the lock-release will activate as will the alarm output. Where the first fingerprint is used only the lock-release activates.
For this functionality choose the corresponding option: **Au** (to activate the auxiliary exit)

Standby Mode

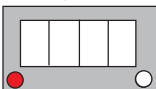

1. Enter the master fingerprint

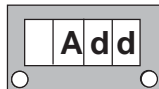

1 beep

Enter Programming Mode

2. Confirm the Add option with the validation key

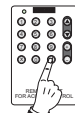

3. **d1.1** is shown. Enter the user fingerprint you wish to register in the system.



4. **d1.2** is shown. Re-enter the user fingerprint you wish to register to confirm the fingerprint.



5. **Relay** is shown. Using the scroll keys the following sequence will appear **relay**, **both**, **Au**.... There are three options the action of which associated with this user fingerprint is:

- **Relay**: to open the door
- **both**: to open the door and activate the auxiliary exit simultaneously.
- **Au**: to activate the auxiliary exit

Select the required option and confirm using the OK key.

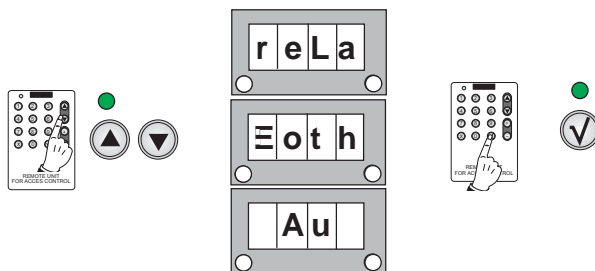

6. **d2** is shown. Confirm the second fingerprint option using the OK key Enter the user fingerprint you wish to use for the functions described in fingerprint mode 2.

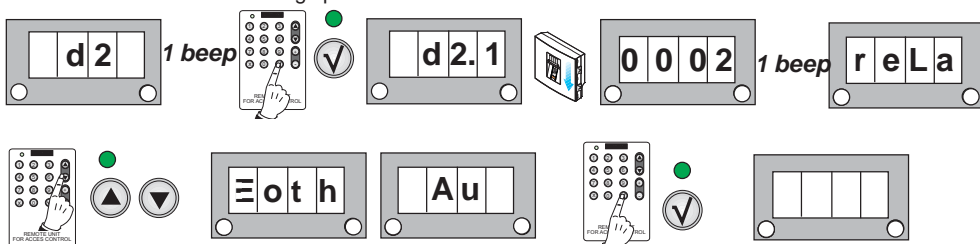

for example: **Au**
(to activate the auxiliary exit)

6b. The reader LEDs start to flash. The reader is ready (LEDs flashing) for a card or code to be entered (if the reader has a keypad).

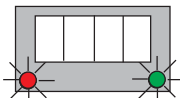

7. Bring close the card that you wish to register. If it has registered correctly **d1.1** is shown.

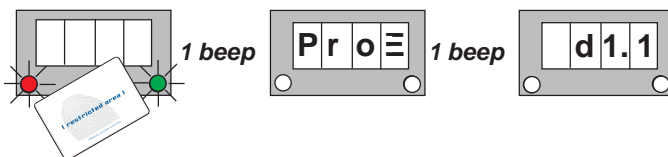

7b. If it was a keypad code (if the reader has a keypad).

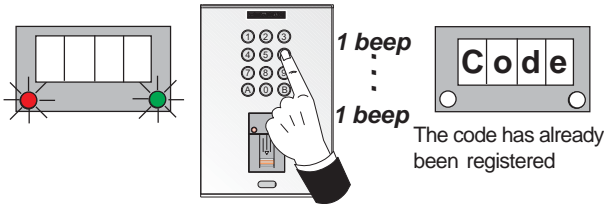

4 or 6 digit code + B. For example:

- 4 digits (① ② ③ ④ + B)
- 6 digits (① ② ③ ④ ③ ④ + B)

8. **d1.1 re-appears**, allowing us to continue registering users. Repeat the aforementioned steps to register new users in mode 2 fingerprints + proximity or code.

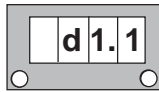

NOTE:

- The choice of number of digits (4 or 6) is chosen using the option: **Code**

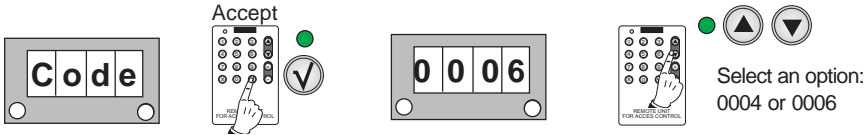

NOTES:

- The same fingerprint cannot be entered twice on different registers (user number), therefore if it is already registered on the system it cannot be re-registered.
- The master fingerprint cannot be the user fingerprint either.
- The same proximity card cannot be entered twice on different registers (user number), therefore if it is already registered on the system it cannot be re-registered.

e) Add user ONLY proximity or code.

Some people's fingerprints do not have the information required to register them in a biometric system. An estimated 1% of the population. In these cases use integrated Proximity or a reader with a keypad to enter a code.

Standby Mode



1. Enter the master fingerprint

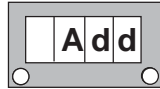

1 beep

Enter Programming Mode

2. Confirm the Add option with the validation key

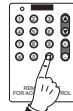

3. **d1.1** is shown. Press the OK key WITHOUT entering the user fingerprint. The user number that will be registered in the system will be shown and the LEDs will flash. The reader is ready (LEDs flashing) for a card or code to be entered (if the reader has a keypad).

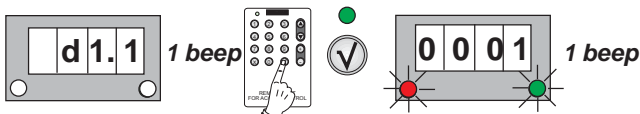

4. Bring close the card that you wish to register. If it has registered correctly **d1.1** is shown.

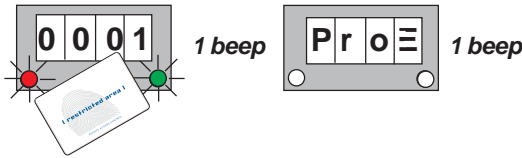

4b If it was a keypad code (if the reader has a keypad).

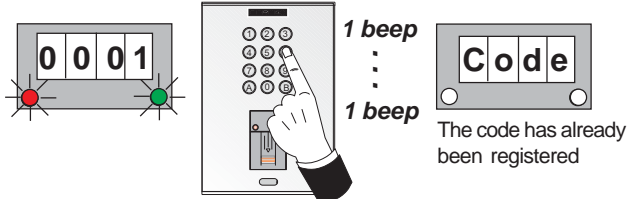

4 or 6 digit code + B. For example:

4 digits (1 2 3 4 + B)
 6 digits (1 2 3 4 3 4 + B)

5. **d1.1 re-appears**, allowing us to continue registering users. Repeat the aforementioned steps to register new users - card or code only.

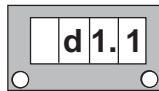

NOTE:

- The choice of number of digits (4 or 6) is chosen using the option: **Code**

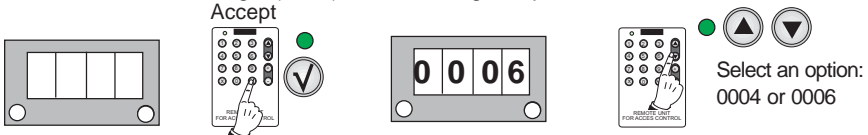

NOTES:

The same proximity card cannot be entered twice on different registers (user number), therefore if it is already registered on the system it cannot be re-registered.

Details: If the card has already been registered in the system an error message will be shown when you try and register it again.



Operation

- User mode 1 or 2 fingerprints.
- User mode 1 or 2 fingerprints + proximity.
- User mode 1 or 2 fingerprints + code.
- User proximity only.
- User ID only.

NOTE:

- For the functioning of users in Security Mode (double security): Fingerprint + Proximity or Fingerprint + Code, in the option: **Mode** the **Sec** mode has to be selected (double security).

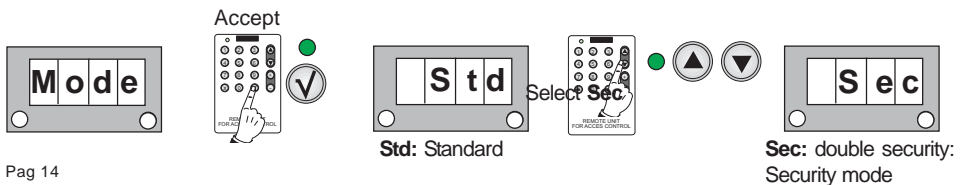

User mode 1 or 2 fingerprints

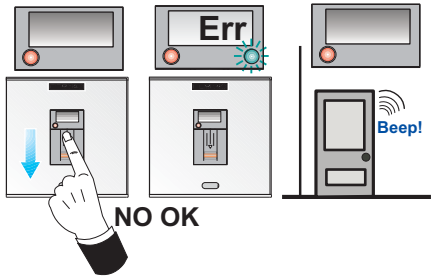
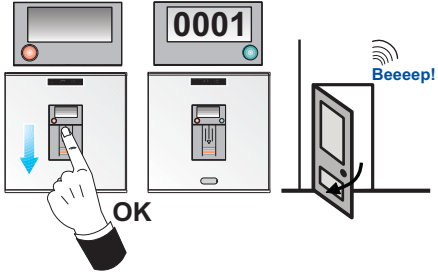

User mode 1 or 2 fingerprints with proximity functioning

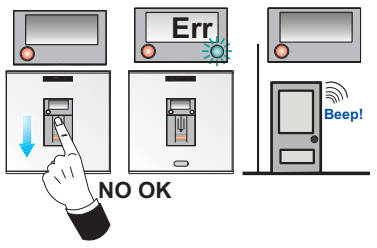
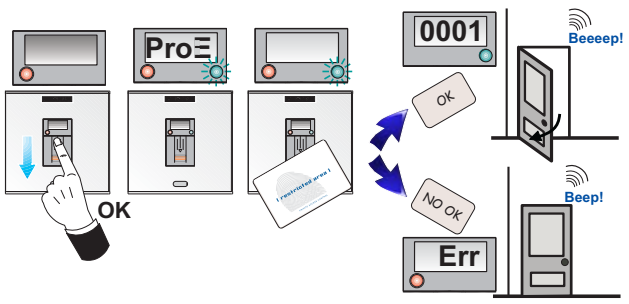

User mode 1 or 2 fingerprints with ID functioning

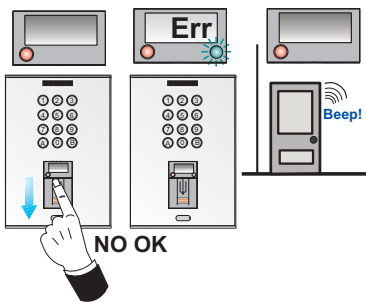
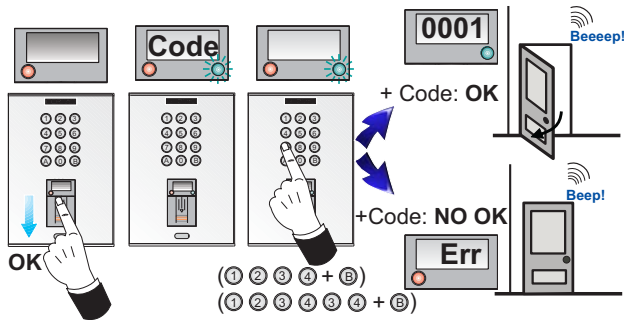

User proximity only functioning

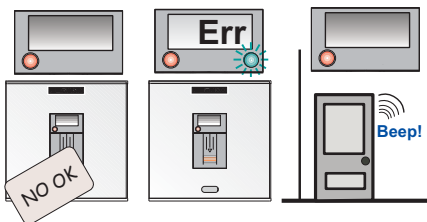
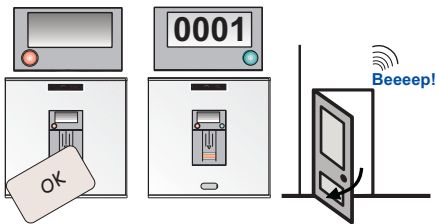

User ID only functioning

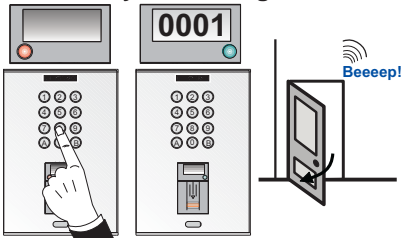

OK

- (1) (2) (3) (4) + (B)
- (1) (2) (3) (4) (3) (4) + (B)

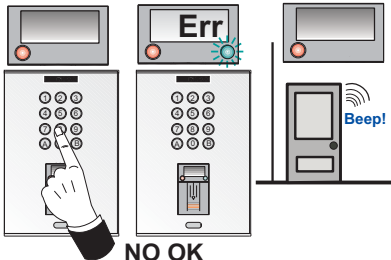

NO OK

- (1) (2) (3) (4) + (B)
- (1) (2) (3) (4) (3) (4) + (B)

Delete Users (ErA)

A registered user can be deleted by entering their **user number**. There is also another option for deleting **all** users on the reader.

a) Delete Users by way of their "user number"

Standby Mode

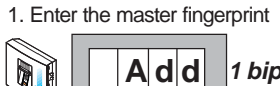
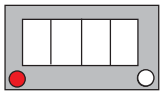

Enter Programming Mode

2. Search using the menu's scroll keys:

ErA

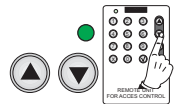

3. ErA is shown. Confirm with the OK key.



4. 0000 is shown. Using the scroll keys the following sequence will appear: 0000, ALL, 0000.... Select the following option: 0000 and enter the "user number" that you wish to delete and confirm with the OK key.



For example:
Number of
User 3

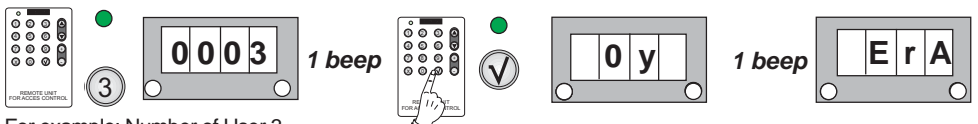

For example: Number of User 3

b) FULL User Reset

Standby Mode

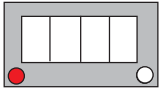

1. Enter the master fingerprint.

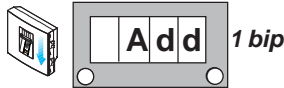

2. Search using the menu's scroll keys:

ErA

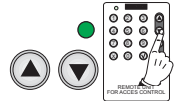

Enter Programming Mode

3. **ErA** is shown. Confirm with the OK key.



4. **0000** is shown. Using the scroll keys the following sequence will appear: **0000**, **ALL**, **0000**... Select the following option: **ALL** and confirm with the OK key.

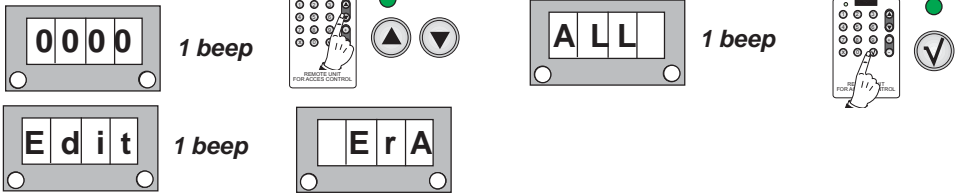

NOTES on the DELETE option:

- Deleting a user or resetting all users are irreversible actions, such that once deleted the information cannot be recovered.
- You can delete a code if you know its associated position, therefore we re-iterate the importance of compiling a table with the users names and numbers.
- If the "user number" entered does not exist or the data is incorrect an error message will appear on the display.

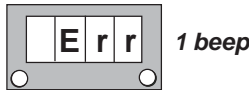

Time Configuration (TeM)

Standby Mode

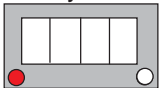

1. Enter the master fingerprint

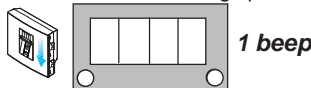

2. Search using the menu's scroll keys:

tEM

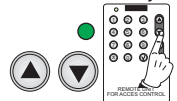

Enter Programming Mode

3. **tEM** is shown. Confirm with the OK key. **TeM** is shown. Using the scroll keys the following sequence will appear: **t.Ab**, **t.ALM**, **t.SE**, **t.Ab**... Select the option you wish to configure.

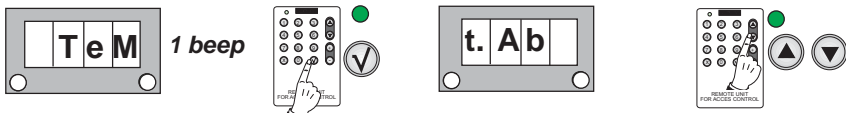

NOTES on "Door Sensor Times" and "Alarm Activation Times" options:

- In options b and c the times are programmed but these functions have to be activated. See the corresponding chapter on: "Auxiliary Output Time".

a) Lock-Release Timing

Time the door's lock-release relay remains active.

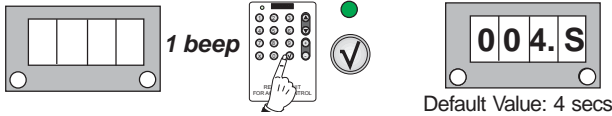

1. Enter the required door opening time of between 01 and 99 seconds.



b) Door Sensor Timing

Maximum time the door can be open before an alarm goes off.

A magnetic door sensor is required. See diagram.

Initially these functions are disabled (000 value).

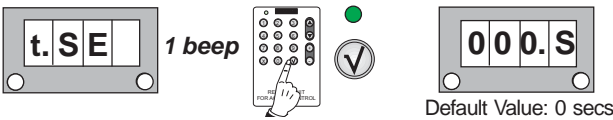

1. Enter a time of between 01 and 99 seconds after which, when the door is open an acoustic alarm integrated into the reader will begin to sound.



c) Alarm Time (auxiliary output)

Time the alarm remains active. Initially these functions are disabled (000 value).

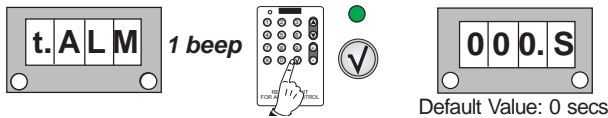

1. Enter the time you wish the alarm to remain active for at between 01 and 99 seconds



NOTE: the sensor time has to be greater than the lock-release time

Auxiliary Output functionality (Au)

The following functions are possible:

- None activated: - - -
- Door and door forced open alarm: **ALP**
- Intruder alarm following an incorrect fingerprint: **ALI**

Only one of these functions can be activated on the system.

NOTE:

- If any of these functions is configured do not associate the exit **Au** (auxiliary exit) with a user fingerprint.

Standby Mode

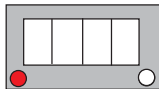

1. Enter the master fingerprint

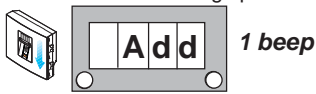

2. Search using the menu's scroll keys:



Enter Programming Mode

3. **Au** is shown. Confirm with the OK key. - - - is shown. Using the scroll keys the following sequence will appear: - - -, **ALI**, **ALP**, - - -.... Select the option you wish to configure.

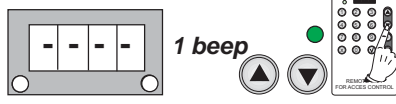

a) No option activated

Initially this function is disabled (- - - value).

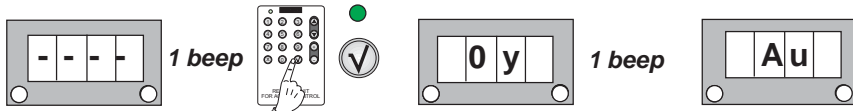

b) Door and door forced open alarm

Door Alarm Activation Option. See the "Door Sensor Time" chapter.

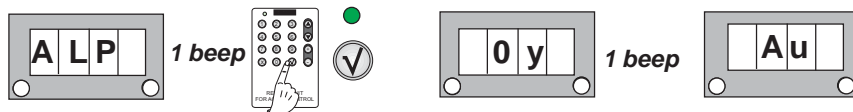

c) Intruder alarm following an incorrect fingerprint

Intruder Alarm Activation Option.

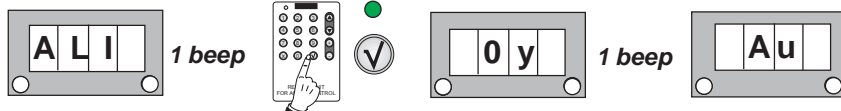

Options with special MASTER (MSt) cards/fingerprints

Within the **MSt** option the following functions are possible:

- Change master fingerprint/card: **MS1**
- Add a second master finger/card **MS2**
- Add a trade finger/card: **trd**
- Add an unblock fingerprint/card: **UnbL**
- Add a fingerprint/card for the security/standard mode: **Seq.**

Standby Mode



1. Enter the master fingerprint

Enter Programming Mode

2. Search using the menu's scroll keys: **MSt**

3. **MSt** is shown. Confirm with the OK key. **MS1** is shown. Using the scroll keys the following sequence will appear: **MS1, MS2, trd, UnbL, Sec, MS1**.... Select the option you wish to configure.

a) Change Master fingerprint/card

The Master fingerprint/card is necessary to enter programming mode. Use this option to change the **master fingerprint** or **register a master card**.

1. **d2.1** is shown, confirm if we wish to register a **master fingerprint**. Enter the new user fingerprint you wish to register as a master fingerprint on the system.

Confirm for master fingerprint.

2. **d2.2** is shown. Enter the fingerprint again to confirm.

1b. **d2.1** is shown, cancel if we wish to register a **master card**. The LEDs of the reader start to flash, present the card that we wish to register in the system as the master card.

b) Add a second master fingerprint/card

To register a **second master card** to allow operation using a second fingerprint if the first has problems (cuts, burns... etc) or register a **second master card**.

1. **d2.1** is shown, confirm if we wish to register a second **master fingerprint**. Enter the new user fingerprint you wish to register as a master fingerprint on the system.

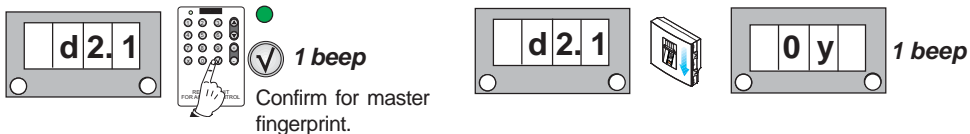

2. **d2.2** is shown. Enter the fingerprint again to confirm.

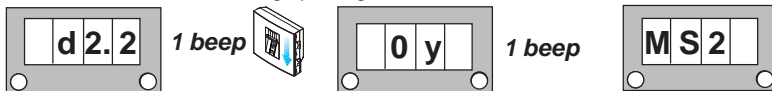

1b. **d2.1** is shown, cancel if we wish to register a **master card**. The LEDs of the reader start to flash, present the card that we wish to register in the system as the master card.

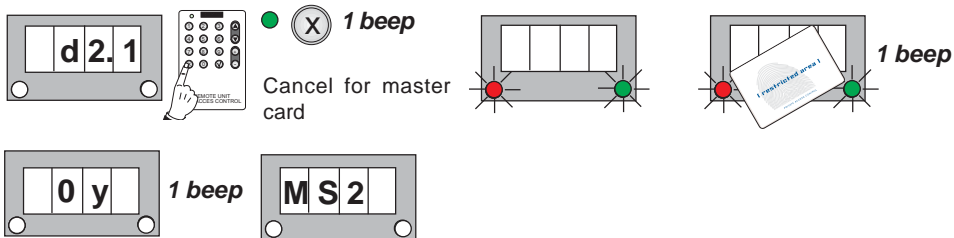

c) Add a trade fingerprint/card

The trades option is a special "free access" function, which is activated from the reader by entering a registered fingerprint/card. As such, we can register **a trade fingerprint** or **a trade card**.

This function is especially useful when you want to offer free access to an area to be controlled. In this mode, any fingerprint/card entered will activate the lock-release.

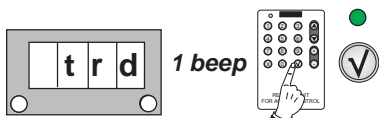

1. **d2.1** is shown, confirm if we wish to register a **trade fingerprint**. Enter the new user fingerprint you wish to register as a trade fingerprint on the system.

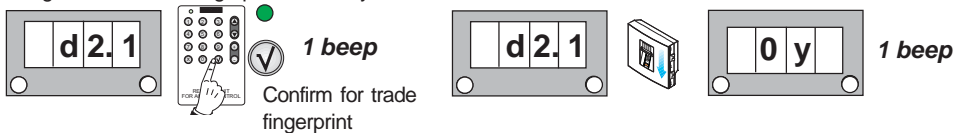

2. **d2.2** is shown. Enter the fingerprint again to confirm.

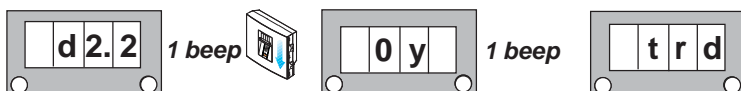

1b. **d2.1** is shown, cancel if we wish to register a **trade card**. The LEDs of the reader start to flash, present the card that we wish to register in the system as the trade card.

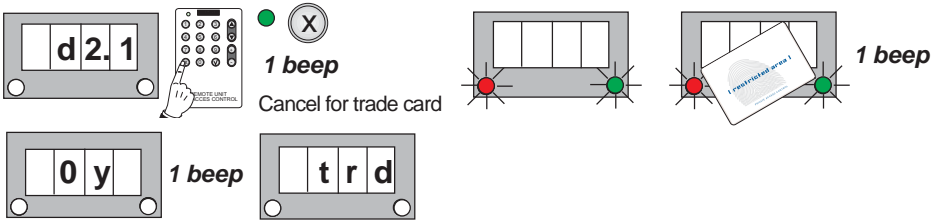

*** Activate the Trades function**

This function is used when you want to offer free access to an area to be controlled. It is activated by sliding the trade fingerprint/presenting the trade card through the reader's sensor when in standby mode . The function remains enabled until the trade fingerprint is entered/the trade card is presented again, and then it will be disabled.

In this mode, any fingerprint/card entered will activate the lock-release. The green LED on the reader will flash when this mode is enabled.

Standby Mode

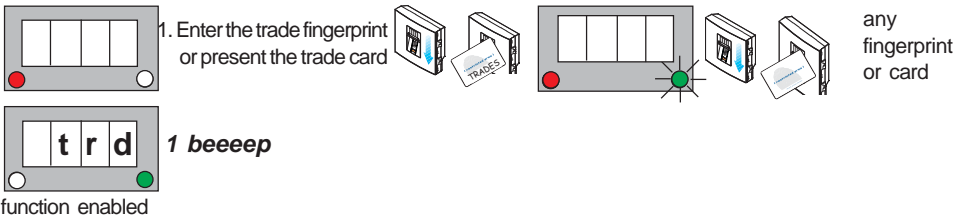

2. Enter the trade fingerprint or present the trade card

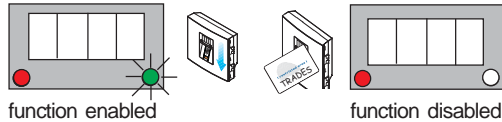

d) Add an unblock fingerprint/card

The Unblock option is a special function. In this mode the lock-release relay remains continuously enabled. You can register an **unblock fingerprint** or **register an unblock card**.

To add an unblock card/fingerprint access the option: **UnbL**.

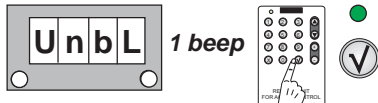

1. **d2.1** is shown, confirm if we wish to register a **unblock fingerprint**. Enter the new user fingerprint you wish to register as an unblock fingerprint on the system.

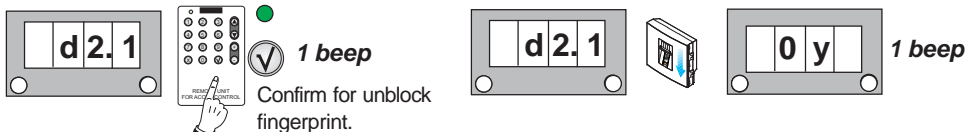

2. **d2.2** is shown. Enter the fingerprint again to confirm.

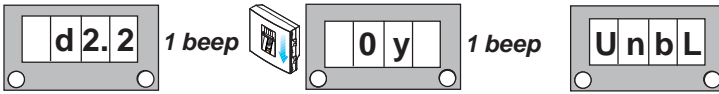

1b. **d2.1** is shown, cancel if we wish to register an **unlock card**. The LEDs of the reader start to flash, present the card that we wish to register in the system as the unlock card.

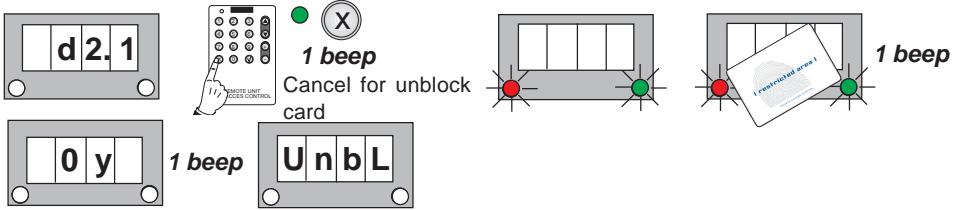

*** Activate the Unblock function**

This function is used when you want the door to remain continuously open. It is activated by sliding the trade fingerprint/presenting the unblock card through the reader's sensor when in standby mode. The function remains enabled until the trade fingerprint is entered/the unblock card is presented again, and then it will be disabled.

The green LED on the reader will remain continuously on when this mode is enabled.

Standby Mode

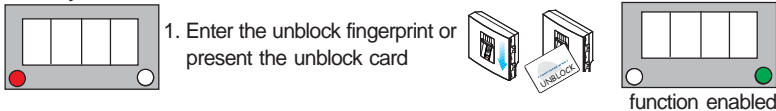

2. Remains activated until the unblock card/fingerprint is entered again.



e) Add a security finger/card

Add a user (security fingerprint or security card) which will allow the reader mode to be changed. Standard or security modes available. See the chapter on: see Operating Modes chapter.

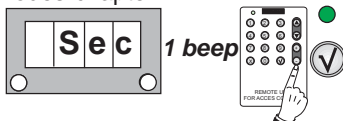

1. **d2.1** is shown, confirm if we wish to register a **security fingerprint**. Enter the new user fingerprint you wish to register as a security fingerprint on the system.

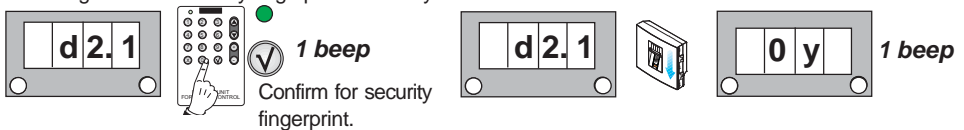

2. **d2.2** is shown. Enter the fingerprint again to confirm.

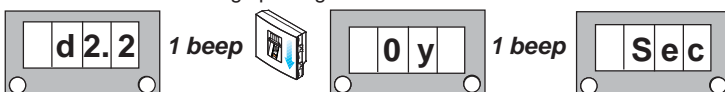

1b. **d2.1** is shown, cancel if we wish to register a **security card**. The LEDs of the reader start to flash, present the card that we wish to register in the system as the security card.

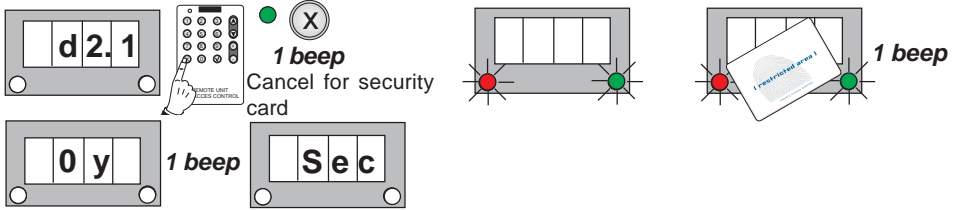

*** Activate the Security/standard operation using the corresponding fingerprint or card registered for this purpose**

Activate one mode or other by sliding the security fingerprint or card over the reader in standby mode. The mode displayed will remain enabled until the security card or fingerprint is presented again. It will then change to the other mode.

Standby Mode



This mode will remain active until the new security fingerprint is entered or the new security card presented (can also be changed by programming. See the chapter on: "Function modes - Mode" below).



Operating Modes (Mode)

- 1. **Standard mode (Std):** double security is not enabled. We only pass the fingerprint or card
- 2. **Security mode (Sec):** double security is enabled: Fingerprint + Card or Fingerprint + Code.

NOTES:

- See functioning (chapter "Add users - Add"):

Standard Mode:

- User mode 1 or 2 fingerprints.
- User proximity only.
- User ID only.

Security mode:

- User mode 1 or 2 fingerprints + proximity.
- User mode 1 or 2 fingerprints + code.

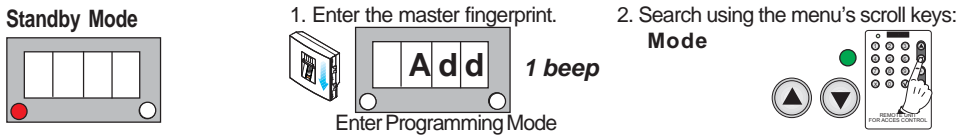

3. Code is shown. Confirm with the OK key.

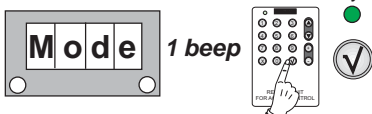

4. **Sec** is shown. Using the scroll keys the following sequence will appear: **Sec, Std, Sec**.... Select the required mode: **Sec** (Security: double security) or **Std** (standard: no double security) and confirm with the OK key.



NOTE:

- In **Security mode**, will only ask for double security if users have registered in this way.

Network Identifier (nEt)

Each reader must have an identifier number to be able to carry out the copy option and this number should not be repeated. This is codified using the dipswitch on the back of the device. All readers are programmed in factory with an identifier number of 1.

Standby Mode

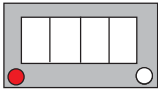

1. Enter the master fingerprint.

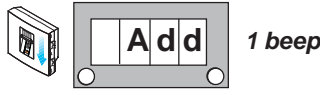

Enter Programming Mode

2. Search using the menu's scroll keys: **nEt**

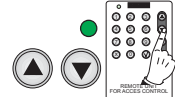

3. **nEt** is shown. Confirm with the OK key. See this **reader's** identifier number (informative purposes).

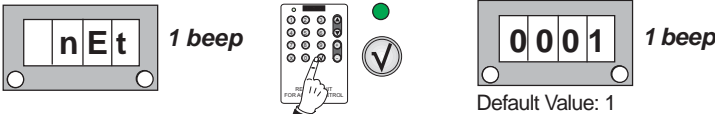

Coding of the reader dipswitch for the network (1...127):
switches 1...7

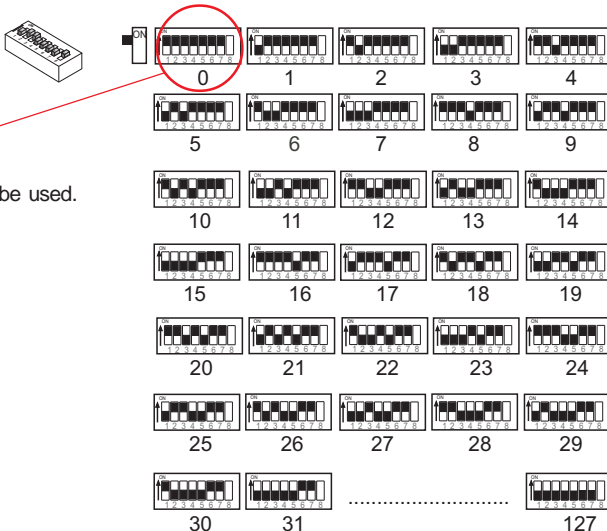

Important note:
Address 0 cannot be used.

Copy (COP)

This operation aims to copy all the data from one reader to another. The following data is copied:

- List of User Fingerprints (**L.NN**)
- Configuration (**C.NN**)

Enter the destination reader number where all the data from the current reader will be copied. The reader number to be copied or the destination reader explained in the option: **“Network Identifier (nEt)”**.

The readers have to be connected using terminals A and B. See diagram.

Standby Mode



1. Enter the master fingerprint.

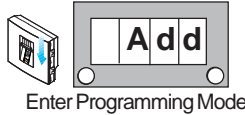

2. Search using the menu's scroll keys: **COP**

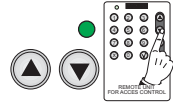

3. **COP** is shown. Confirm with the OK key.

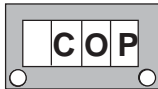

1 beep

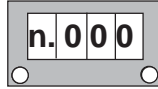
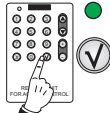

default value: 0

4. Enter a destination reader number of between 1 and 127, on which the system data will be stored.

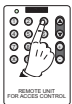

1 beep

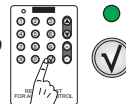

For example: Destination reader 3 (the green LED of the destination reader will flash whilst it is receiving the information).

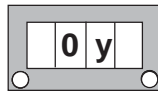

1 beep

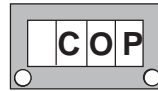

NOTE: the copying time is proportional to the number of fingerprints stored. Do not disconnect until the process is finished.

Clone diagram

CLASS I
AUTÓNOMO
STAND ALONE
8: ON

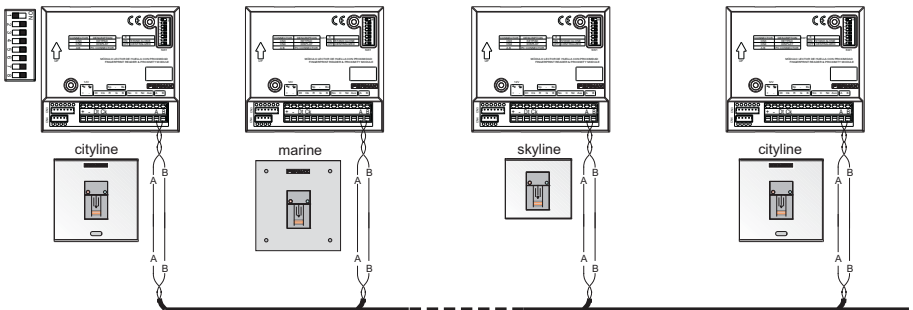

2. Code length - number of digits (Code)

Number of digits to use in the keyboard code. 4 or 6.

NOTES:

- See functioning (chapter "Add users - Add"):

Standby Mode

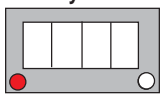

1. Enter the master fingerprint **1 beep**

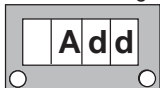

Enter Programming Mode

2. Search using the menu's scroll keys: **Code**

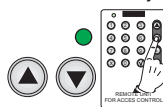

3. **Code** is shown. Confirm with the OK key.

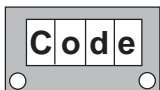

1 beep

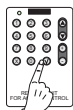

4. **0006** is shown. Using the scroll keys the following sequence will appear: **0006, 0004, 0006...** Select the number of required digits: **4** or **6** and confirm with the OK key.

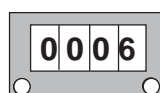

1 beep



Communications protocol in centralised system (Prot)

No autonomous function

Resetting the Master Code (where the previous code is forgotten)

This operation is carried out by electrically modifying the equipment, in the aim of ensuring it is impossible for anyone without physical access to the equipment to modify it in any way.

1. Disconnect the system's power supply.

Mode Not Set-Up



2. Short-circuit "Bs" and the system "-".

If the system is equipped with an exit button, just press and hold it down.

3. Reconnect the system's power supply and do not remove the short circuit.

Once powered up **Ini** will appear on the display

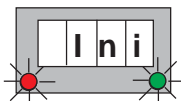

1 beep

Enter the master fingerprint or present the master card

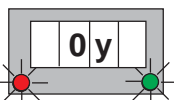
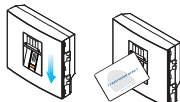

1 beep

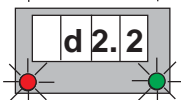

1 beep

- Confirm the master fingerprint or card

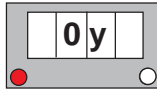
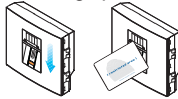

1 beep

4. Disconnect the system's power supply. Remove short-circuit between the system's "Bs" and "-". Reconnect the power supply.

Technical Characteristics

Power supply: 12 Vac / 12 Vdc.

Operating temperature: -10° to 55° C.

Consumption:

* **On standby:** 12Vac: 215 mA / 12Vdc: 150 mA

Capacity:

- Number of users:
 - * 4500 (1 user fingerprint)
 - * 2970 (2 fingerprints per user)
- Number of administrators: 2 master fingerprints/cards
- Door Opening Time: 1...99 seconds
- Door Sensor Timing: 0...99 seconds
- Auxiliary exit activation time: 0...99 seconds
- Number of fingerprints configurable per user (1 or 2)
- Number of incidents without online limit
- Number of readers in network: 127 (001...127)

Default Values:

- Door opening time: 4 seconds
- Door sensor time: 0 seconds (not activated)
- Auxiliary exit activation time: 0 seconds (not activated)
- Mode: Standard
- Auxiliary output function: none
- Network identifier number: 1
- Standalone

Panel Connectors:

~ ~ / +, -: (12 Vac/Vdc) power supply

No, Nc, C: lock-release relay output (potential free)

- C1: common
- No - Nc: normally open (No) or normally closed (Nc) contact

Bs, -: output button

Sp, -: door sensor

Aux: auxiliary/panic output. Collector output open. Maximum current of 125 mA

A, B: Cloned reader connection.

Dt, Ck: conexión datos a controlador (no disponible).

R: led rojo a controlador (no disponible).

G: led verde a controlador (no disponible).

B: buzzer a controlador (no disponible).

Molex connectors:

molex connection display: +, -, D, C

molex connection keypad: +, -, PI, Ck, Si, -, VI

Dip-switch: to select the reader and system addresses: autonomous or centralised.

Wiring Diagram

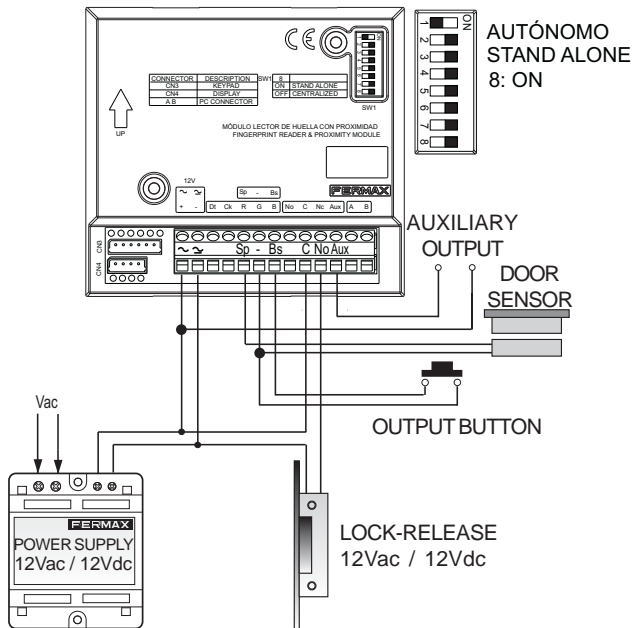

Guía rápida de programación

Function Code	Function Description
Add d1.1/d1.2 - rela/both/Au d2/d2.1- rela/both/Au leds-card-Prox	Add Users: - 1 Fingerprint Mode (1 fingerprint) - 2 Fingerprint Mode (2 fingerprints) - Card
ErA 000 ALL	Delete user: - Per user number - Full reset of all users
TeM t. Ab t. SE t. AL	Time Configuration: - Lock-Release Timing - Door Sensor Timing - Alarm Time (auxiliary output)
AU - - - ALP ALI	Auxiliary Output Time - No function activated - Door and door forced open alarm - Intruder Alarm (incorrect fingerprint)

Function Code	Function Description
MSt	Special fingerprint functions:
MS1	- Change the master fingerprint:
MS2	- Add a second master fingerprint
trd	- Add a trade fingerprint
Unb	- Add an unblock fingerprint
Sec	- Add a fingerprint, security mode
Mode	Operating Modes:
Std	- Standard (no double security)
Sec	- Security (double security)
nEt	Network Identifier
Prot	No autonomous function.
COP	Copy
Code	Number of code digits

Installation

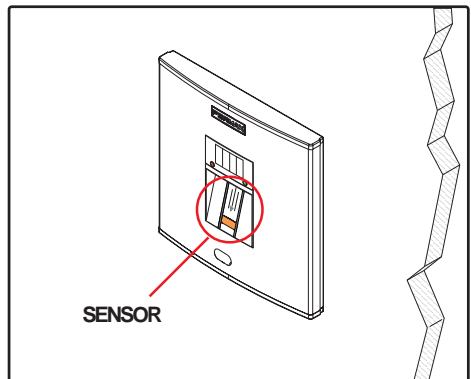
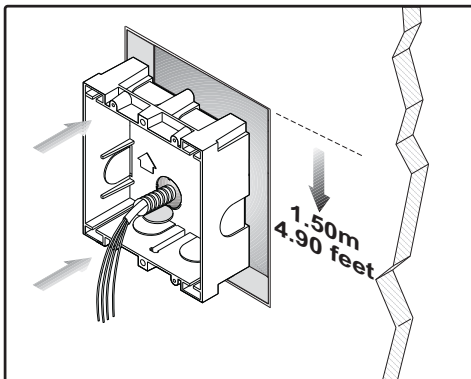

NOTE:

- The reader sensor should be at an **approximate** height of between 1.40 and 1.60 metres, independent of the chosen panel.
- An example will be indicated on the installation diagram, assuming it is located on a series 1 panel.

Maintenance Recommendations

If the reader is installed outside and is wet, the sensor should be removed to ensure its correct operation (before entering a fingerprint).

Any variation in the users' fingerprints used on the system, such as humidity, dirtetc could result in correct reading of the fingerprint.

Usage Recommendations

To ensure the fingerprint is read correctly, the user should run their finger downwards along the reader (from top to bottom), at a constant speed and exercising light pressure.

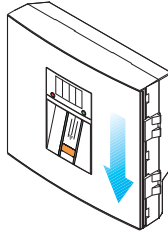

Installation/Replacement of the battery in the remote control

The remote keypad is supplied with power via the integrated battery (CR2025).

Battery Replacement:

- a) Lift the lid as indicated by the arrow (to the right) and move in the indicated direction (downwards).
- b) Remove the used battery and insert the new one in the same position. The + sign on the battery facing upwards.

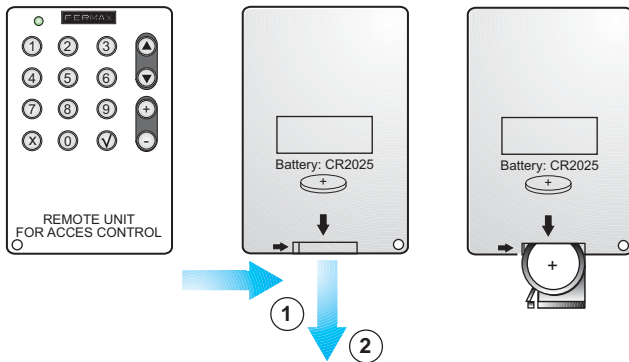

Deposit the battery in the appropriate collection point for the recycling.

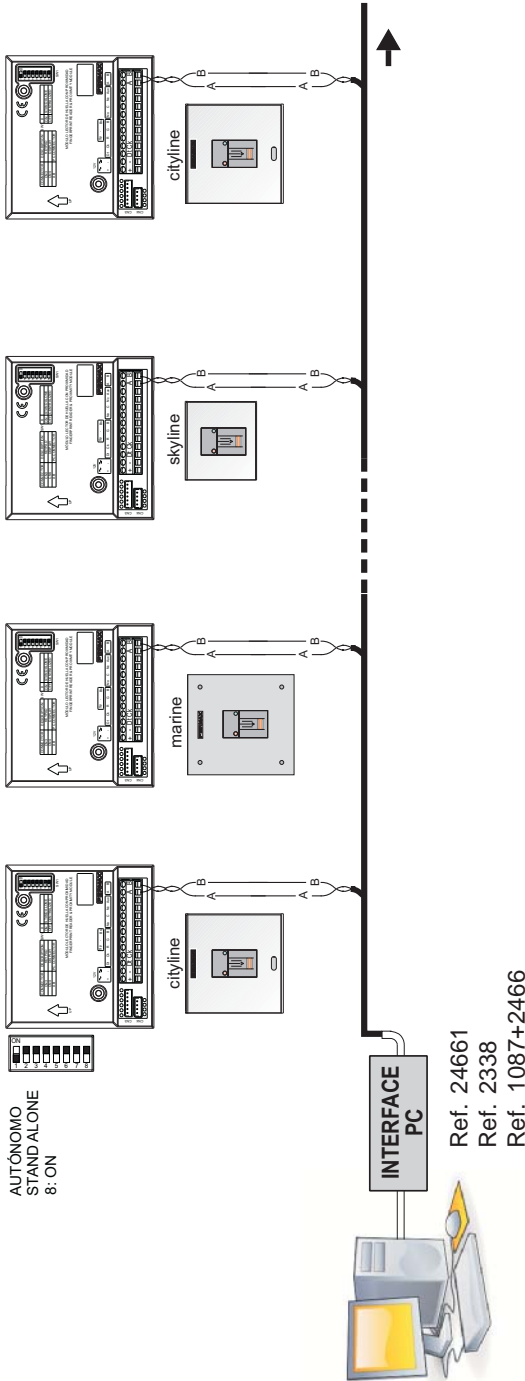

IMPORTANT:

Prior considerations before using the fingerprint software:

- a) Assign a different network ID for each fingerprint reader. See option: **Network Identifier (nEt)**.

FERMAX