

CONGRATULATIONS ON PURCHASING THIS QUALITY PRODUCT!

Fermax electronics develops and manufactures well known systems that meet the highest standards of design and technology.

Your FERMAX video door entry system will allow you to communicate with the entry panel, see who is calling you and open the front door if you wish. We hope you enjoy its range of functions.

www.fermax.com.

Technical publication of an informative nature published by FERMAX ELECTRONICA S.A.E.

As part of its constant improvement policy, FERMAX ELECTRONICA S.A.E. reserves the right to modify the content of this document and the features of the products referenced therein at any time and without prior notice.

Any modification will be reflected in subsequent editions of this document.

TABLE OF CONTENTS

iLOFT TELEPHONE 4

Installation 4

 Connections 6

 Diagrams 6

 Capacity 7

 Technical Features 7

 Telephone Programming 8

 - From the entry panel 8

 - From the telephone 9

 Telephone Settings 11

 - Ringtone Selection 11

 * Main Panel 11

 * Secondary Panel 11

 - Call Volume Regulation 12

 - Resetting Parameters 13

 - SIMPLEX Conversation Mode 14

 - Automatic Door Opening (DOORMATIC) 15

 Operation 17

 - Buttons 17

 * Lock-Release Button/Call to Guard 17

 * Audio Activation /Hang-Up/Autostart Button 18

 * F1 Additional Functions Button 18

 - Led Signals 19

 - Available Functions: 19

 - Operation 20

 * Answering a call 20

 • «Handsfree» Mode 20

 • «Simplex» Mode 20

 * Opening the door 21

 * «Automatic Door Opening» (DOORMATIC) Mode 21

 * Canceling Ringtones 21

TELEPHONE INSTALLATION

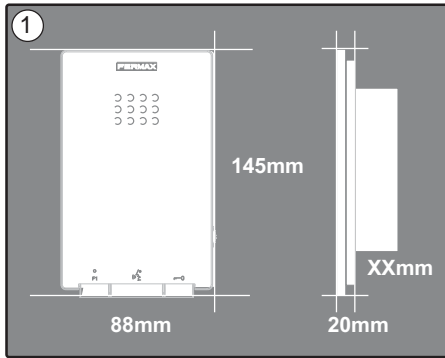

Telephone Dimensions(Height x Width x Depth*):
146 x 90 x 20 mm

Note:

- this telephone can be installed directly at surface level, attached to the wall or in a standard flush mounted box.
- **XX** : standard box.

Grid Positioning Details

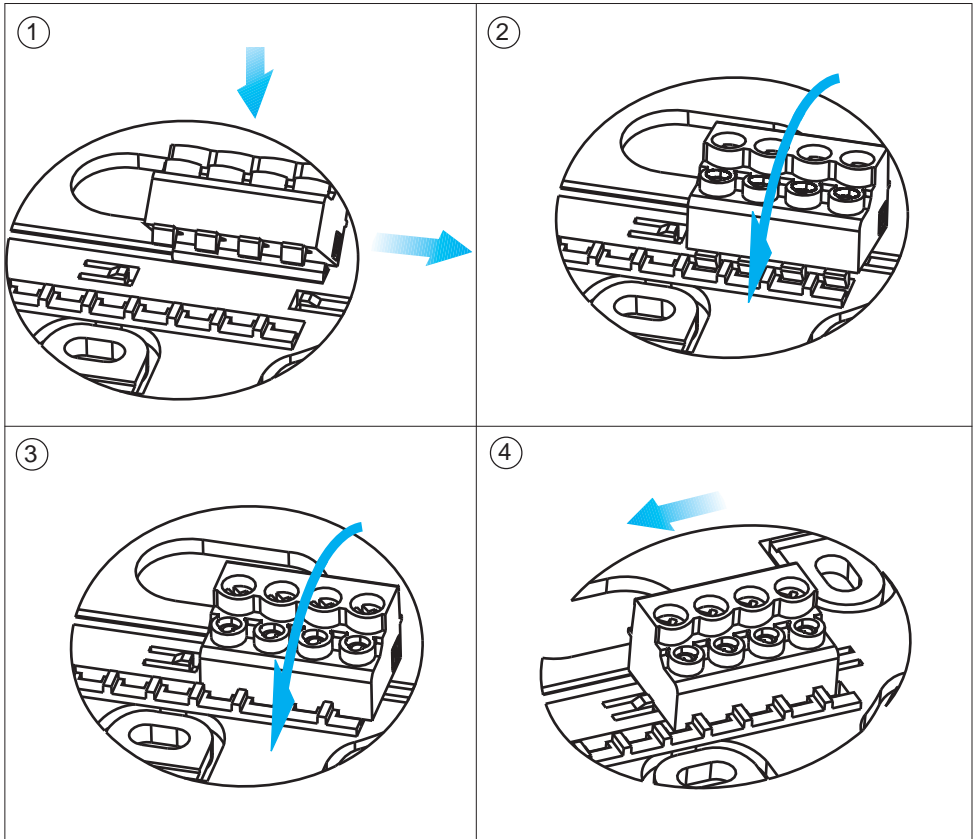

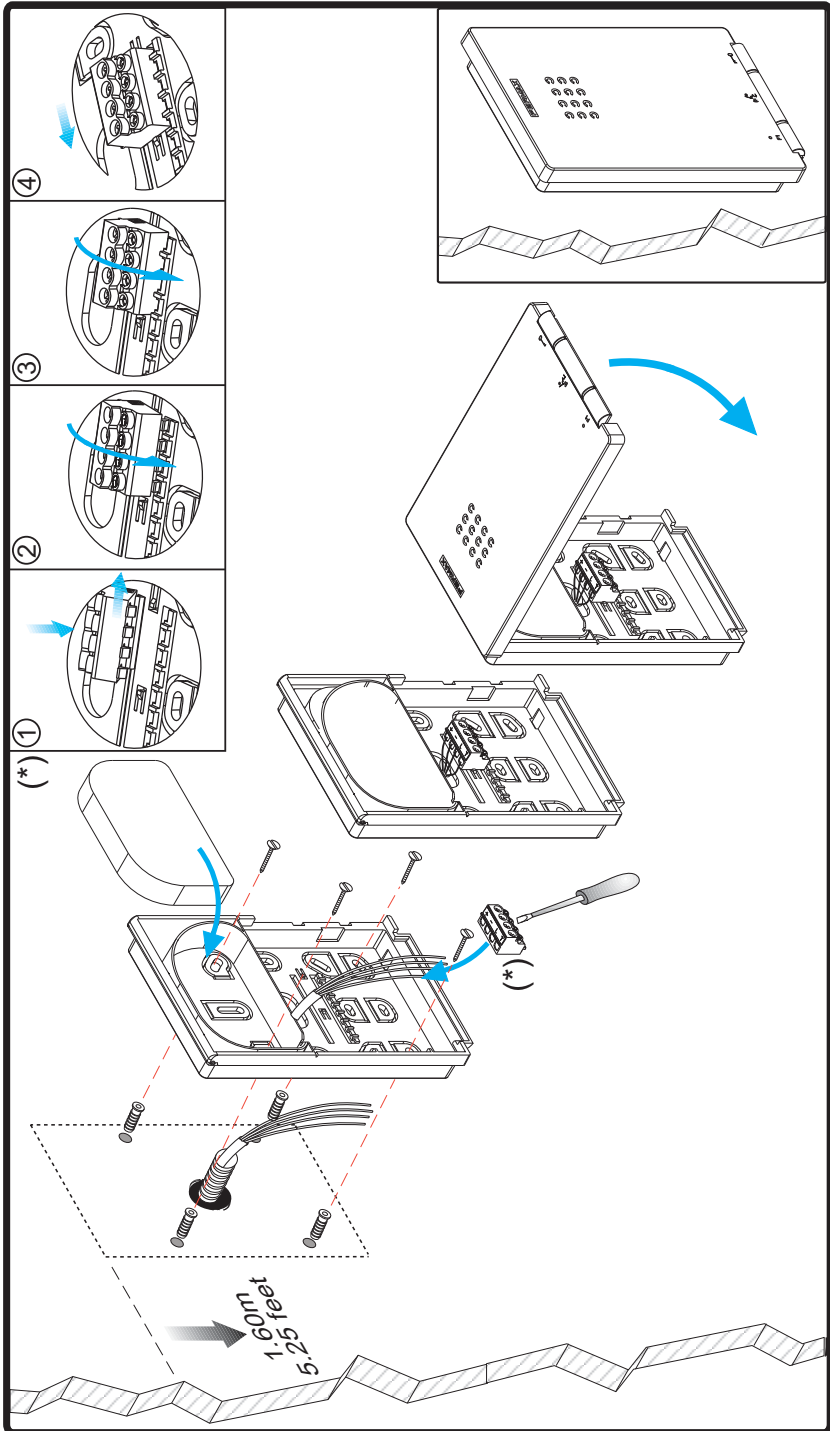

CONNECTIONS

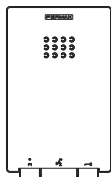

Connection

- **Connection Terminals:**

+, -: Power supply (18 Vdc).

L: Data Bus.

T, -: Call Button Connection for Residential Door (**P1**)

+A, -A: Call extension connection or light and bell activator

Ab: Open Collector Output. When the lock-release command is sent, it sends a negative signal to activate any external devices.

F1: Button for Additional Functions. Input/Output. Configured by default as an output, sending a negative signal. See more details in «iLOFT Telephone Operation - F1».

- **CN1 Connector :**

1. **+**: Positive VDS (+18 Vdc)

2. **-**: Negative VDS

3. **L:** VDS Audio and Data

4. **T:** Doorbell Connection

- Supported via a negative wire
- NA Contact

5. **+A:** Call Extension Output / Light Activator.

6. **-A:** Call Extension Negative Connection / Light Activator.

7. **Ab:** Lock-Release Output

8. **F1:** Input/Output.

- **CN2 Connector :** 2.54mm molex connector for the speaker

DIAGRAMS

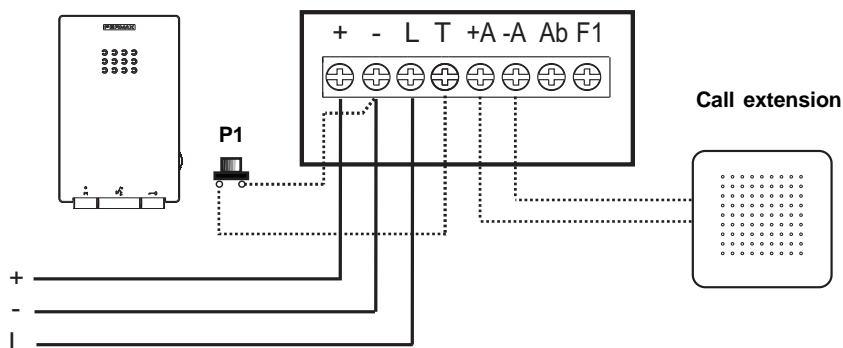

P1: An external button can be installed to act as a «doorbell».

Note: The doorbell tone is set and cannot be modified. In this way it differs from those available on the entry panels.

+A, -A: The telephone has a number of terminals where you can connect a call extension device ref. 2040 or a light and bell activator ref. 2438, which is activated when a call is made from either the entry panel or the residence's main door in the same way as with the iLoft video model.

Note: Where the call is disconnected, the call extension device will not ring, nor will the light and bell activator activate.

CAPACITY.

- Number of terminals per residence: maximum 4.
 Number of terminals per block: 199.
 Number of communication channels: 1.
 Wiring: 3 polarised wires. CAT-5 compatible.
 Number of different ringtones available: 5.
 Call volume regulation (8 levels).
 Maximum conversation time. 90 seconds
 Maximum time to pick up on receiving the call: 30 seconds
 Maximum time to programme the telephone: 150 seconds.
 Default conversation mode: Duplex.

TECHNICAL FEATURES

	Power Supply	18 Vdc
	Consumption on standby	24 mA
	with audio	100 mA
Operating Temperature		[-5°C , +40 °C]
Humidity		[5 - 95%]
Telephone Dimensions(Height x Width x Depth*.):		146 x 90 x 20 mm

1^o. Programming an address from the entry panel (main)

With the telephone connected:

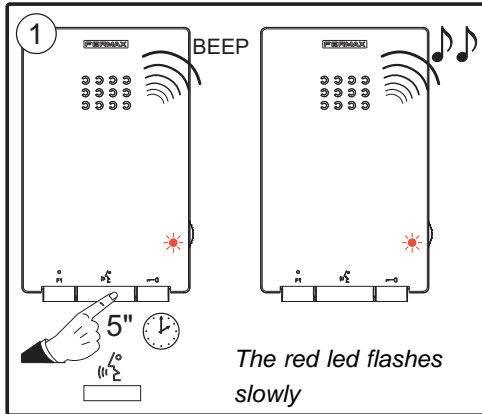

1. The user should start from the «Ringtone Selection» configuration menu. Press and hold the button for 5 seconds until you hear a «beep» then release, a ringtone will sound on the main panel and the red led will flash slowly. While in this mode:

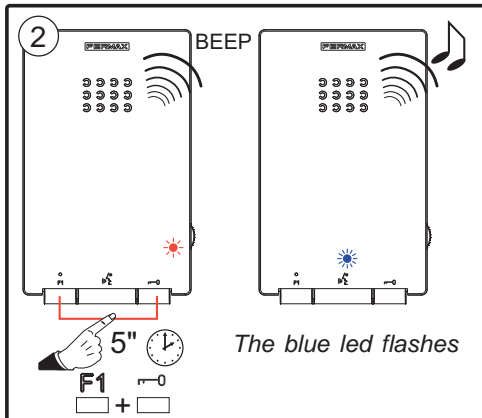

2. Press the F1 and the button simultaneously for 5 seconds until you hear a tone (BEEP). Releasing the button sends a panel configuration command (blue led flashing).

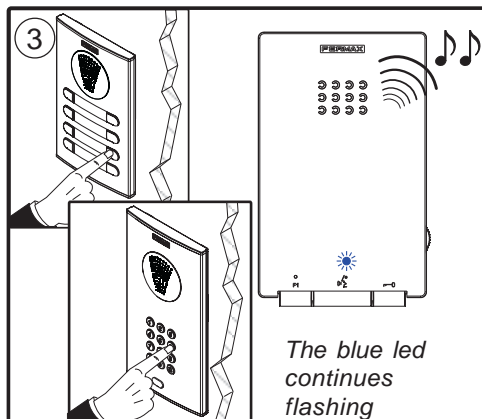

3. Press the button/residential call code from the panel. A confirmation tone will sound on the telephone. The telephone is now programmed.

Note: When the telephone has not been programmed the blue led will flash very slowly.

2°. Programming the address from the telephone.

The call code can be programmed on the telephone without the need for a call from the entry panel.

With the telephone connected:

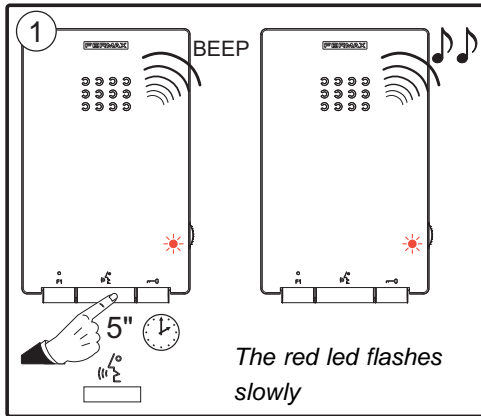

1. The user should start from the «Ringtone Selection» configuration menu. Press F1 and hold the button for 5 seconds until you hear a «beep» then release, a ringtone will sound on the main panel and the red led will flash slowly. While in this mode:

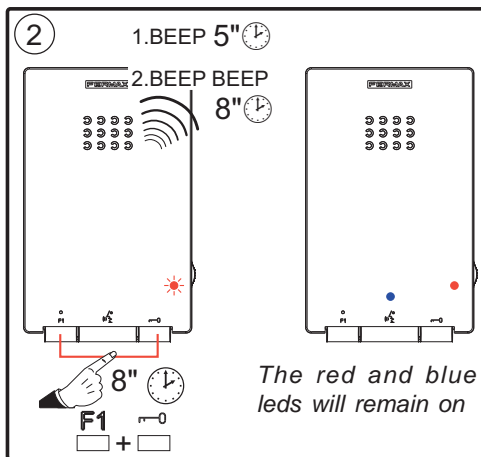

2. Press the F1 and the \rightarrow button simultaneously for 8 seconds until you hear a double tone (BEEP BEEP) and release. The blue and red led remain on.

Note: after 5 seconds you will hear a BEEP, continue to hold down the F1 and \rightarrow button for the 8 seconds until you hear the double BEEP.

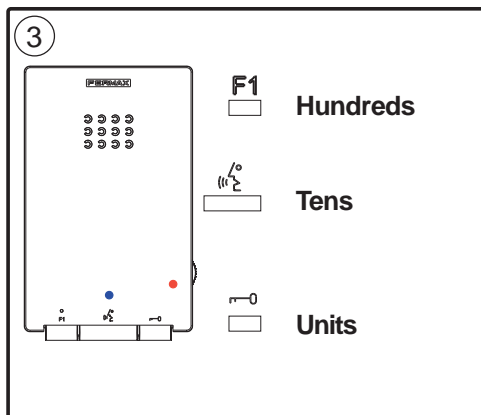

3. The user presses the telephone buttons corresponding to hundreds, tens and units to configure the code.

Every time one of these buttons is pressed a BEEP will sound and the corresponding number will increase, always starting from 000.

Once you reach 9 pressing the button again will return you to 0 and an error tone will sound. The next time you press the button it will start from the number 1.

Note: In this case no audio will be available on the entry panel.

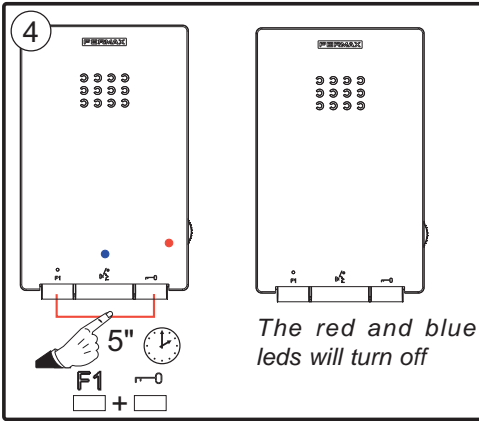

4. The address is confirmed pressing the F1 and \rightarrow button simultaneously for 5 seconds. We know the address has been programmed because the red and blue leds turn off (return to standby mode).

If this is not pressed no address will be confirmed.

Note: If 60 seconds elapse without you having confirmed the selected address, the monitor will remain programmed with the last address stored before entering programming mode.

Note: When the telephone has not been programmed the blue led will flash very slowly.

Example: Programming Code 143.

1. Access to the «Ringtone Selection» configuration menu.
2. Access to the «Address via telephone» programming menu.

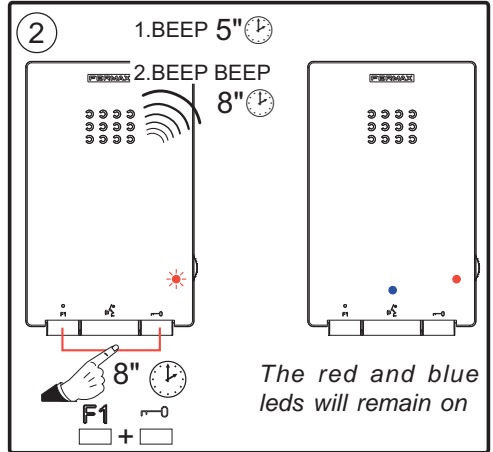
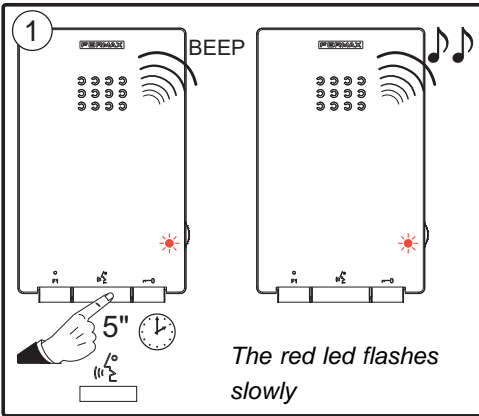

3. Press code 143.

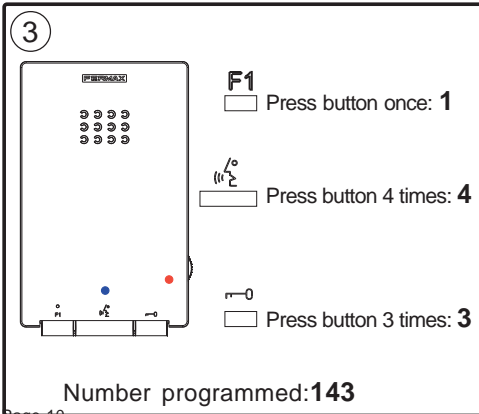

4. Save new address and return to standby.

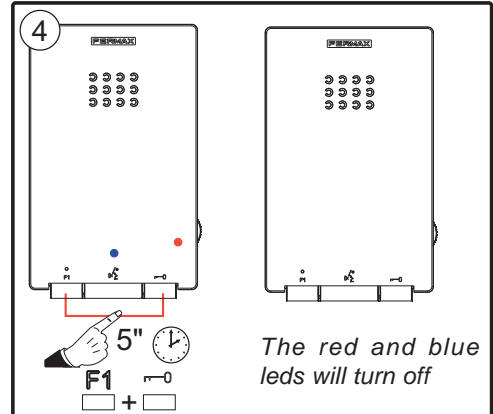

iLOFT TELEPHONE SETTINGS

Ringtone Selection.

The telephone allows you to select different ringtones for calls from the main panel and the secondary panel.

Accessing «Ringtone Selection» Mode:

From standby mode:

Ringtone for calls coming from the Main Panel:

1. Press $\mu\tau$ and hold the button for 5 seconds until you hear a «beep» then release, a ringtone will sound on the main panel and the red led will flash slowly.
2. Press the F1 button to select the ringtone, (circular sequence), the last one played will be the one selected. Red led - slow flash.

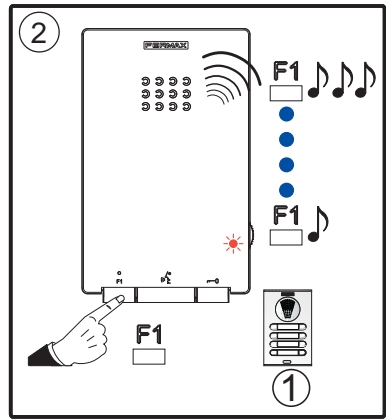
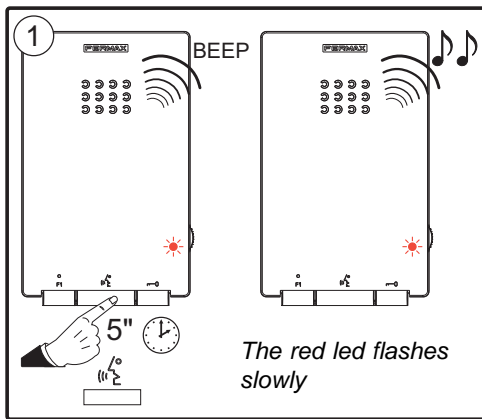

Ringtone for calls coming from the Secondary Panel:

3. While in «Ringtone Selection for Main Panel» mode press the $\mu\tau$ button to select «Ringtone Configuration for Secondary Panel, the secondary panel's ringtone will sound and the red led will flash rapidly.
4. Press the F1 button to select the ringtone, (circular sequence), the last one played will be the one selected. Red led - slow flash.

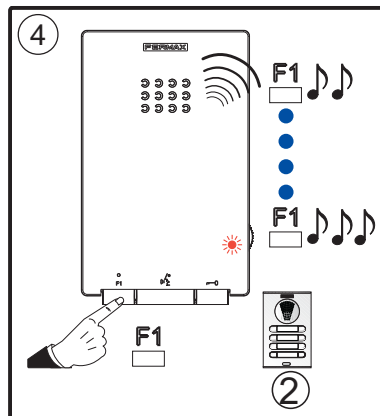
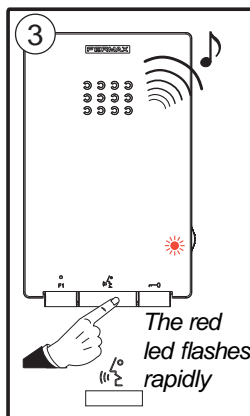

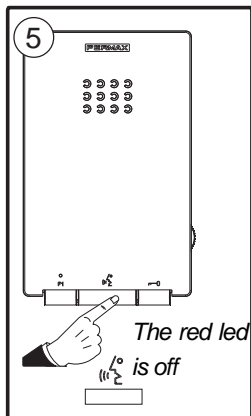

Exit ringtone selection (standby):

- While in «Ringtone Selection for Secondary Panel» mode press the M button to return to standby mode (red led off).

Note:

- The current ringtone will sound on entering each option.
- If you want to listen to the current ringtone without changing it, press the M button twice consecutively.
- The ringtone volume will depend on the setting selected on the lateral potentiometer.
- The volume can be altered while playing the ringtones.

Call Volume Regulation

Starting from standby mode, use the potentiometer to adjust the call volume to any setting between the maximum and minimum levels (8 settings).

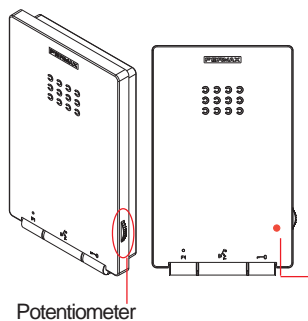

Note:

- The setting affects all ringtones generated by the telephone: entry panels and doorbell.
- To hear the selected setting you can: make a call from the entry panel. enter ringtone selection mode.
- Call volume regulation does not affect the input audio settings.
- If during call volume regulation the potentiometer is turned down to its minimum level, a constant red led will light up to indicate that the **call has been disconnected**.
- The disconnection option affects all ringtones generated by the telephone.
- Where the call is disconnected, the call extension device will not ring, nor will the light and bell activator activate.
- To re-activate the call, you must move the potentiometer above the minimum level.
- The blue led flashes when a call is being received whether enabled or not.

Resetting Parameters

To set all the telephone parameters to default without deprogramming the call number, (useful when the user has doubts over the parameters programmed).

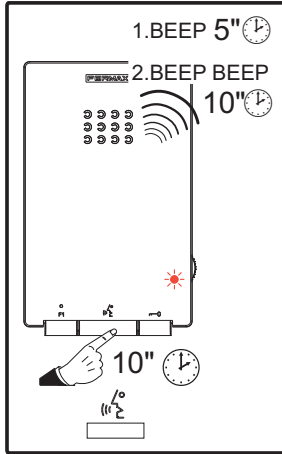

Press and hold the **10** button for 10 seconds. The telephone will emit a short double beep and will reset all parameters to their default settings without deprogramming the call code.

Note:

- *The parameters reset to default are: automatic opening mode disconnected, audio and call volume settings, hands free mode.*

Simplex Conversation Mode.

Default conversation mode on the telephone is «handsfree»

During a «handsfree» conversation, you can reset to simplex conversation mode (press the $\mu\text{Σ}$ button to speak and release to listen).

1. From «handsfree» mode: press the F1 and $\mu\text{Σ}$ button simultaneously until you hear a «BEEP» and see the blue led flashing intermittently, while input audio remains active (you can hear the panel on the telephone).

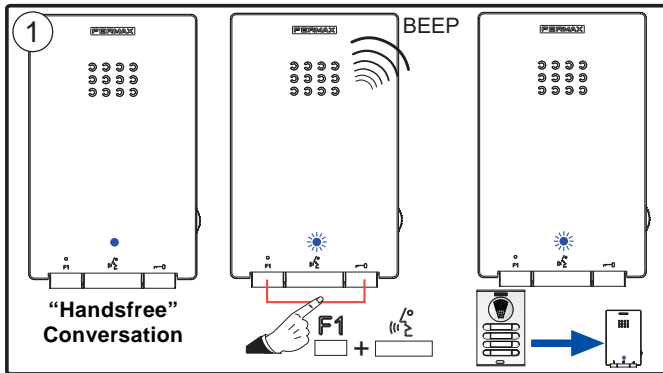

audio channel
Entry Panel - Residence

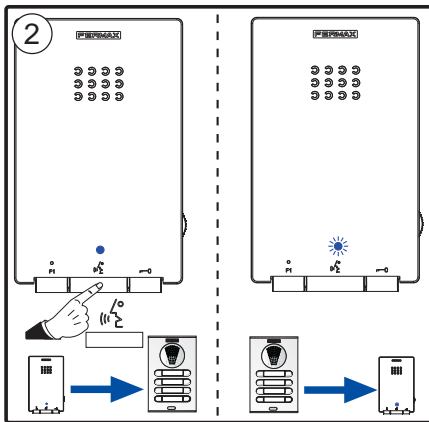

audio channel
Residence - Entry Panel audio channel
Entry Panel - Residence

2. From this point every time you press the $\mu\text{Σ}$ button, the output audio channel will activate (you will hear the telephone on the panel) and a constant blue led will light up.

On releasing the $\mu\text{Σ}$ button the input audio channel will activate (you will hear the panel on the telephone) and the intermittent blue led will light up.

Once you enter «simplex mode» it will remain activated by default. The next time the audio is connected, the input channel will activate when you press the $\mu\text{Σ}$ button (short press).

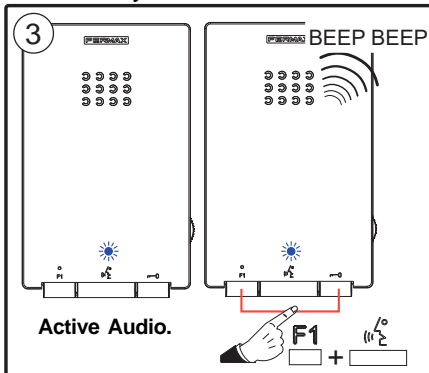

3. To re-establish «handsfree» conversation mode once the audio channel is open, press the F1 and $\mu\text{Σ}$ button simultaneously until you hear «BEEP BEEP».

Automatic Opening (DOORMATIC).

In this mode, when a call is received from the entry panel the lock-release is activated once the ringtone stops.

The open door function is disabled by default.

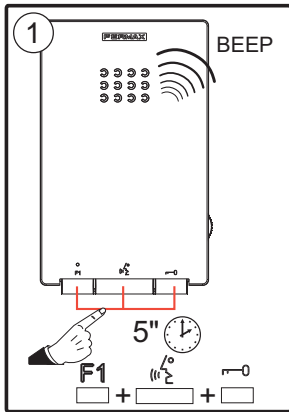

1. To **enable** this mode, hold down the three buttons simultaneously for 5 seconds until you hear a BEEP: F1 button, [Lock] button and [Doorbell] button.

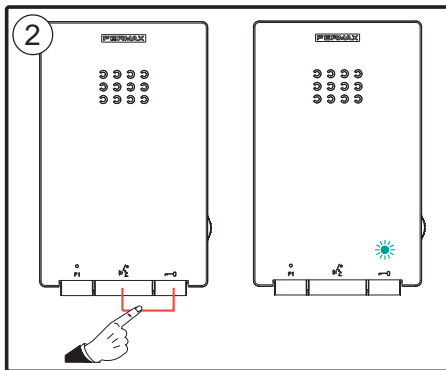

2. To **activate** the function, you must hold down [Lock] button and [Doorbell] button simultaneously until you see the green light flashing.

Once this is activated the door will automatically open when a call is received.

Note:

- The automatic door function **CANNOT** be activated if it has not be previously enabled.

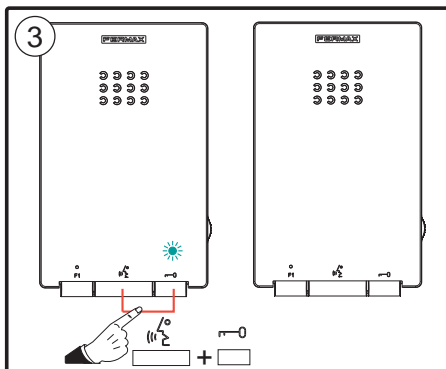

3. To **deactivate** the function, you must hold down [Lock] button and [Doorbell] button simultaneously until you see the green light turn off.

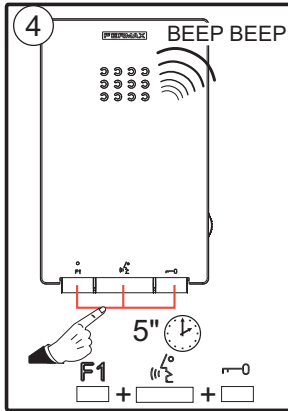

4. To **disable** this mode, hold down the three buttons simultaneously for 5 seconds until you hear a BEEP BEEP: F1 button, F2 button and F3 button.

Note:

- There is also an option to connect a timer to the doorbell (if this is not being used) so that the automatic opening function is activated and deactivated each day at certain times. If activated for a period of 30 seconds it determines that the automatic door function should be activated. When this doorbell feature is deactivated this function will also be deactivated.

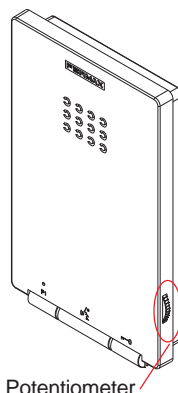
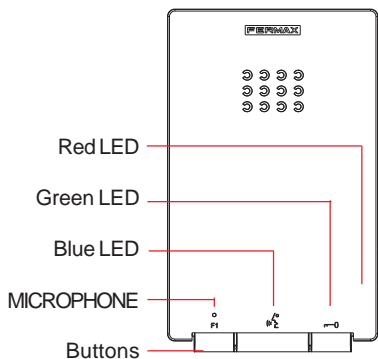

Buttons

 Lock Release / Call Guard Unit Button

- Pressing this button activates the lock-release. The door can be opened at any time. When the lock-release command is sent, the *Ab terminal* sends a negative signal to activate any external devices (where applicable).
- When you press this button with the telephone on the hook (no audio), a call will be made to the guard (where one exists). A beep will sound, indicating that the action has been confirmed.



 Audio activation, hang up and auto-start button

On receiving a call the user has 30 seconds to answer. The blue led flashes during this time to indicate a call waiting.

- *Audio activation*: when a call is received, press and release this button to speak to the visitor. The audio channel between the entry panel and the residence is opened; operating in hands-free mode. The blue led will remain on indicating that a conversation with the entry panel is underway.
- *Hang-Up*: press to end communication, if not the conversation will be disconnected after 90 seconds. Once disconnected the blue led will turn off.
- *Auto-start (main panel)*: on standby, press and release this button (the blue led lights up).

Note:

- The conversation is private, no other terminal can hear it.
- «Handsfree» mode is default mode.
- While the audio channel is open the input audio can be regulated with the potentiometer, without affecting the call volume. The selected setting will not be altered if the call volume is subsequently adjusted.
- If the channel is busy an error tone «BEEP» will be generated and auto-start will not activate.
- If the telephone is configured in «simplex mode», (press to speak and release to listen), the audio channel will be activated to hear sound at street level.
- The auto-start function is always used on the main panel except where a call is received on the secondary panel. Once the conversation is over auto-start will activate on the secondary panel for 30 seconds. After this time it will activate on the main panel.
- During the conversation «handsfree» can be adjusted to «simplex mode». Page 17

F1 F1: Button for Additional Functions.

- Operating Modes:

- Initially configured by default as an output, sending a negative signal.

Note:

- An auxiliary relay can be activated from the telephone and is connected to the F1 terminal for any extra functions such as lighting, alarm activation, etc.
- In conjunction with an MDS/ADS decoder (version V2.5 or above) a panic alarm can be sent to the MDS guard unit. On pressing the F1 button the corresponding command is sent via the bus, while the telephone's output is activated so as to be able to activate the sensors (MDS).

Note:

- Where an MDS Panic Guard Unit is installed, the telephone will use the F1 terminal as an input instead of an output, such that an external panic button can be installed which will send the corresponding F1 command when the telephone is activated.

To send the command the option must be enabled either via the:

- o MDS Panic Guard Unit in DAY MODE
- o Within the **«Programming the telephone address via the telephone» menu**. Return to standby mode by pressing: $\overline{\text{F1}} + \overline{\text{F1}} + \overline{\text{F1}}$ (simultaneously).

Panic Guard Unit - MODE Selection

1. Enter programming mode by pressing «0».
The display offers a series of instructions.

2. Pressing «B» and «3» repeatedly until you have completed the steps and the display shows *the current operating mode*.

3. Use the arrow keys to select the required *operating mode*:
NIGHT
DAY

4. Press «B» when the required *operating mode* appears on the display.

While in the «Programming the telephone's address from the telephone» menu

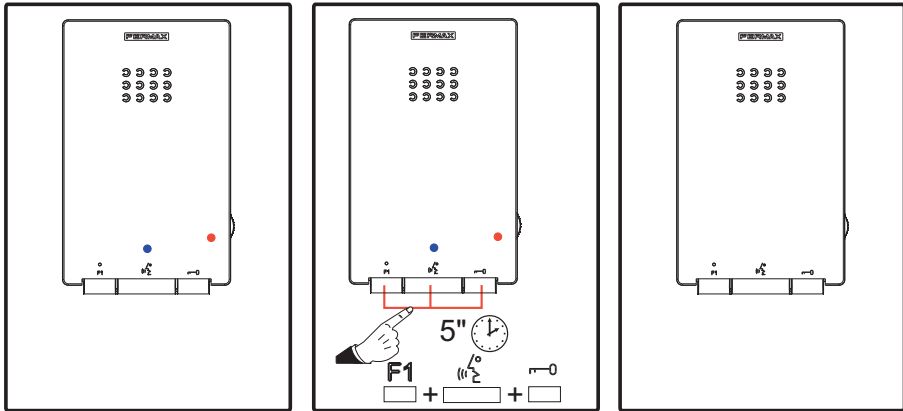

1. While in the menu for «Programming the telephone's address from the telephone» (the red and blue leds will stay on).
2. To **enable** this mode, hold down the three buttons simultaneously for 5 seconds until you hear a BEEP and the leds turn off: F1 button, button $\mu\text{Σ}$ and button r-0 .

If on the other hand you want to **disable the F1 command option** you can do this via the:

- o MDS Panic Guard Unit in NIGHT MODE See previous page.
- o Within the «**Programming the telephone address via the telephone**» menu. Return to standby mode by pressing: r-0 + F1 (simultaneously).

Note:

- On deactivating the F1 command option, the F1 will simply function as an output.

While in the «Programming the telephone's address from the telephone» menu

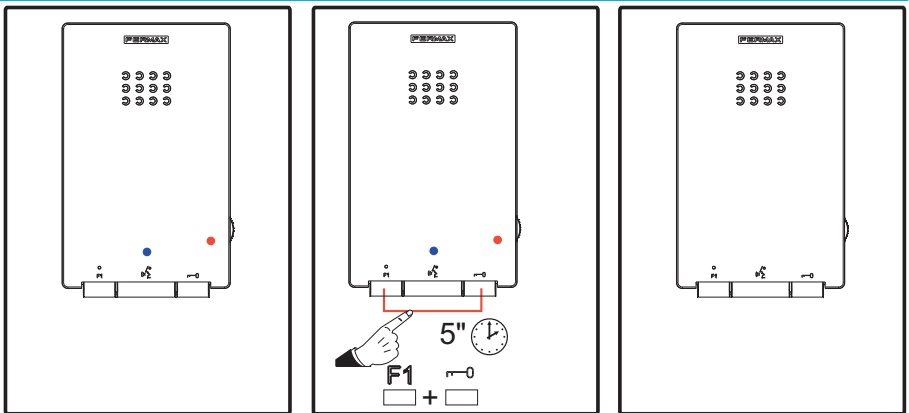



1. While in the menu for «Programming the telephone's address from the telephone» (the red and blue leds will stay on).
2. **Disable** this mode, hold down the three buttons simultaneously for 5 seconds until you hear a BEEP and the leds turn off: F1 button and button r-0 .

F1

F1: Button for Additional Functions.

Led Signals

STATUS (Telephone)	Blue Led 	Green Led 	Red Led
Not programmed	very slow intermittent		
Standby			
Call	rapid intermittent		
Handsfree audio	constant		
Output Audio (simplex mode)	constant		
Input Audio (simplex mode)	slow intermittent		
Do not Disturb			constant
Auto Opening (Doormatic)		slow intermittent	
Select Ringtone Panel 1			slow intermittent
Select Ringtone Panel 2			rapid intermittent
Address Programming	constant		constant

AVAILABLE FUNCTIONS

- Door Opening and Automatic Door Opening (DOORMATIC)
- Call to Guard (where one exists)
- Call volume regulation (8 levels)
- Call Disconnection (Do not Disturb)
- Ringtone Selection (5 options)
- Doorbell
- Programming via the terminal and via the entry panel
- Input audio volume regulation
- Simultaneous activation of the Ab auxiliary output while opening the door
- Simultaneous activation of the F1 auxiliary output while pressing the F1 button
- Activation of lights and bells during the call

Operation

Answering a call.

When the call button on the **entry panel** is pressed a call tone is emitted both from the entry panel and the telephone.

On receiving a call on the telephone the user has 30 seconds to answer. The blue led flashes during this time to indicate a call waiting.

- **Audio activation:** When a call is received, press and release $\mu\zeta$ button to speak to the visitor. The audio channel between the entry panel and the residence is opened; **operating in hands-free mode**. The blue led will remain on indicating that a conversation with the entry panel is underway.
- **Hang-Up:** press $\mu\zeta$ to end communication, if not the conversation will be disconnected after 90 seconds. Once disconnected the blue led will turn off.
- **Auto-start (main panel):** while on standby, press and release $\mu\zeta$ button (the blue led lights up).

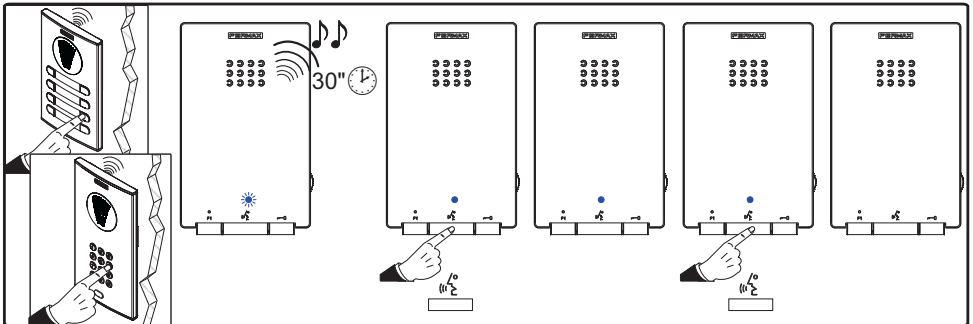

While in simplex conversation mode (press the $\mu\zeta$ button to speak and release to listen).

When the call button on the **Entry Panel** is pressed a call tone is emitted both from the entry panel and the telephone.

On receiving a call on the telephone the user has 30 seconds to answer. The blue led flashes during this time to indicate a call waiting.

- Press and release the $\mu\zeta$ button, the blue led will continue to flash, the input audio will remain active (you will hear the panel on the telephone).

From this point every time you press the $\mu\zeta$ button, the output audio channel will activate (you will hear the telephone on the panel) and a constant blue led will light up.

On releasing the $\mu\zeta$ button the input audio channel will activate (you will hear the panel on the telephone) and the intermittent blue led will light up.

- **Hang-Up:** press $\mu\zeta$ to end communication, if not the conversation will be disconnected after 90 seconds. Once disconnected the blue led will turn off.
- **Auto-start (main panel):** with the telephone on standby, press and release this button $\mu\zeta$ (short press), the blue led lights up (indicates simplex mode).

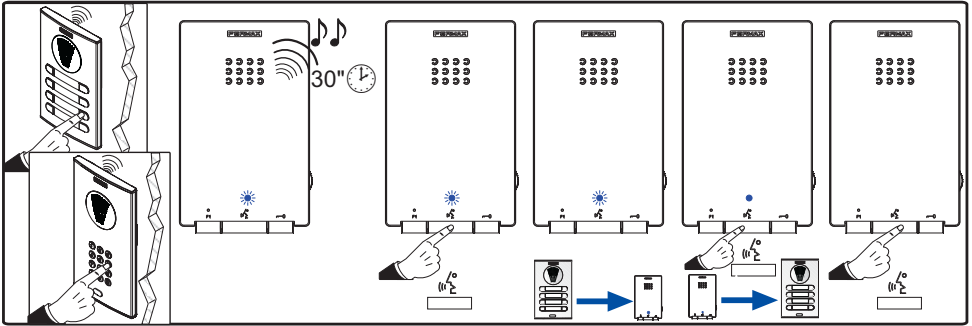

audio channel audio channel
Entry Panel - Residence Residence - Entry Panel

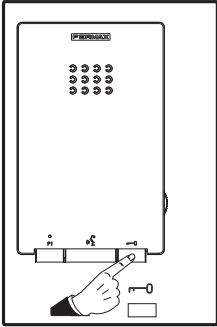

Opening the Door

When a call is received from the entry panel, you can open the door at any time, by pressing the 0 button.

When the lock-release command is sent, the Ab terminal sends a negative signal to activate any external devices (where applicable).

«Automatic Opening» (DOORMATIC) Mode

With «Automatic Opening» **activated**, when a call is received from the entry panel, the lock-release is activated once the ringtone stops.

The open door function is disabled by default. It must be **pre-enabled** (by the installer), **to be able to be activated** by the user.

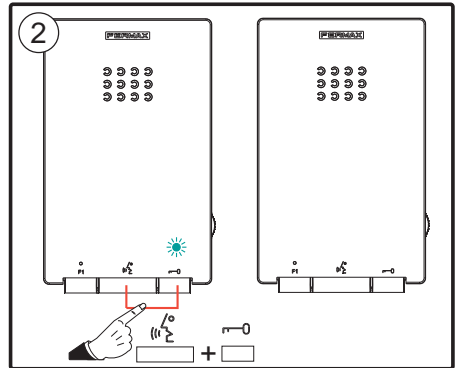
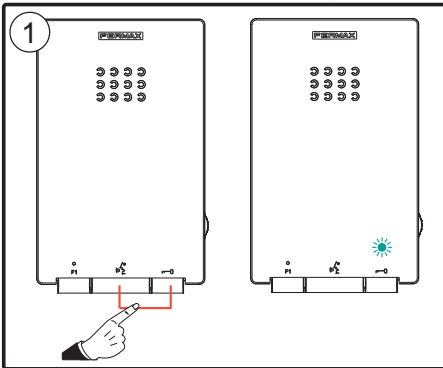

1. To **activate** the function, you must hold down the 0 button and Ab button simultaneously until you see the green light flashing.

Once this is activated the door will automatically open when a call is received.

2. To **deactivate** the function, you must hold down 0 button and Ab button simultaneously until you see the green light turn off.

Important Note:

- The automatic door function CANNOT be activated if it has not been previously enabled.

- When the «Automatic Opening» function is activated and a call is received from the entry panel and the lock-release is activated, a negative signal will be sent via the «Ab» terminal for a period of a second.

Canceling the Ring Tone

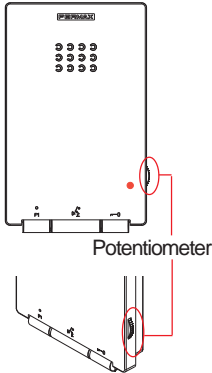

If during call volume regulation the potentiometer is turned down to its minimum level, a constant red led will light up to indicate that the call has been disconnected.

The disconnection option affects all ringtones generated by the telephone:

To deactivate ringtone cancellation, you must move the potentiometer above the minimum level. The led will return to its previous status.

Note:

- The blue led flashes when a call is being received whether enabled or not.
- Where the call is disconnected, the call extension device will not ring, nor will the light and bell activator activate.
- For more operating information: See «**Call Volume Regulation**».

F1 (Additional Functions)

Query with your installer with regard to which functions have been programmed.

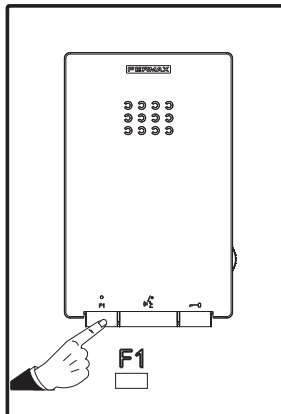

Options:

- An auxiliary relay can be activated from the telephone and is connected to the F1 terminal for any extra functions such as lighting, alarm activation, etc.
- A panic call can be sent from the MDS guard unit to activate the sensors (MDS), in addition to the telephone activating an output.

FERMAX