

FERMAX

MONITOR iLOFT BUS2
BUS2 iLOFT MONITOR
MONITEUR iLOFT BUS2
BUS2 iLOFT MONITOR
MONITOR iLOFT BUS2
MONITOR iLOFT BUS2

MANUAL DE INSTALADOR Y USUARIO
USER & INSTALLER'S MANUAL
MANUEL D'INSTALLATION ET UTILISATION
INSTALLATIONS-und BENUTZERHANDBUCH
MANUAL DO INSTALADOR E USUÁRIO
MANUALE DELL'INSTALLATORE E UTENTE

MANUAL DE USUARIO USER'S MANUAL MANUEL D'UTILISATION BENUTZE
MANUAL DO USUÁRIO MANUAL DE USUÁRIO USER'S MANUAL MANUEL D'
HANDBUCH MANUAL DO USUÁRIO MANUAL DE USUARIO USER'
UTILISATION BENUTZERHANDBUCH MANUAL DO USUÁRIO MA
UAL MANUEL D'UTILISATION BENUTZERHANDBUCH MANUAL
INSTALADOR INSTALLER'S MANUAL MANUEL D'INSTALLATION
ONSHANDBUCH MANUAL DO INSTALADOR MANUAL DE INSTAL
S MANUAL MANUEL D'INSTALLATION INSTALLATIONSHANDBUC
H INSTALADOR MANUAL DE INSTALADOR INSTALLER'S MANUA
INSTALLATION INSTALLATIONSHANDBUCH MANUAL DO INSTALA
USUARIO USER'S MANUAL MANUEL D'UTILISATION BENUTZE

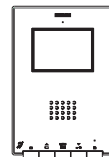
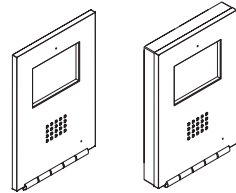

ESPAÑOL
ENGLISH
FRANÇAIS
DEUTSCH
PORTUGÜES
ITALIANO

E ¡ENHORABUENA POR DISPONER DE UN PRODUCTO DE CALIDAD!

Fermax electrónica desarrolla y fabrica equipos de prestigio que cumplen los más altos estándares de diseño y tecnología.

Su monitor de videoportero FERMAX le permitirá comunicarse con la placa de calle, ver la persona que le está llamando y abrirle la puerta de entrada si así lo desea. Esperamos disfrute de sus funcionalidades.

EN CONGRATULATIONS ON PURCHASING THIS QUALITY PRODUCT!

Fermax Electronics develops and manufactures reputable equipment which fulfils the highest design and technology standards.

Your FERMAX video door entry system allows you to communicate with the entry panel, to see who is calling and to open the door if you wish. We hope you enjoy its range of functions.

F FÉLICITATIONS ! VOUS VENEZ D'ACQUÉRIR UN VÉRITABLE PRODUIT DE QUALITÉ!

Fermax Electrónica développe et fabrique des équipements de prestige qui répondent aux normes de design et technologie les plus développées.

Votre moniteur pour portier vidéo FERMAX vous permettra de communiquer avec la platine de rue, de voir la personne qui vous appelle et d'ouvrir la porte d'entrée si vous le souhaitez. Nous espérons que vous profiterez pleinement de toutes ses fonctions.

D WIR GRATULIEREN IHNEN ZUM KAUF DIESES QUALITÄTSPRODUKTS!

Fermax Electrónica entwickelt und fabriziert hochwertige Anlagen, die den höchsten Technologie- und Designstandards entsprechen.

Der Monitor der Videotürsprechanlage von FERMAX ermöglicht Ihnen eine Sprechverbindung mit der Türstation herzustellen, die Person, mit der Sie sprechen auf dem Bildschirm zu betrachten und bei Bedarf die Tür zu öffnen. Überzeugende Funktionalität für Ihr Eigenheim!

P PARABÉNS POR DISPOR DE UM PRODUTO DE QUALIDADE!

Fermax electrónica desenvolve e fabrica equipas de prestígio que cumprem com os mais altos estándares de desenho e tecnologia.

O seu monitor de vídeo-porteiro FERMAX lhe permitirá comunicar-se com a placa da rua, ver a pessoa que lhe está a chamar e abrir-lhe a porta de entrada se assim o deseja. Esperamos que aproveites as suas funcionalidades.

IT CONGRATULAZIONI PER AVER ACQUISTATO UN PRODOTTO DI QUALITÀ!

Fermax electrónica sviluppa e fabbrica apparecchiature prestigiose conformi ai più alti standard di design e di tecnologia.

Il monitor del videocitofono FERMAX vi permetterà di comunicare con il posto esterno, di vedere il visitatore, e di aprirle la porta di ingresso se lo desiderate. Ci auguriamo che possiate sfruttare appieno le potenzialità di questa apparecchiatura.

www.fermax.com

Monitor iLOFT BUS2

Cod. 97485g V03_12

INDICE - INDEX SOMMAIRE - INHALT - INDICE

E	MONITOR iLOFT	6
	Instalación Monitor	6
	Conexiones	8
	Características Técnicas	8
	Esquemas	9
	Programación del monitor	10
	Funcionamiento	13
	Ajustes del monitor	16
	Mantenimiento (limpieza)	78
EN	MONITOR iLOFT	17
	Installing the Monitor	18
	Connections	20
	Technical Characteristics	20
	Wiring Diagrams	21
	Programming the monitor	22
	Operation	25
	Monitor settings	28
	Maintenance (cleaning)	78
F	MONITEUR iLOFT	29
	Installation moniteur	30
	Connexions	32
	Caractéristiques techniques	32
	Schémas de câblage	33
	Programmation du moniteur	34
	Fonctionnement	37
	Réglages du moniteur	40
	Maintenance (nettoyage)	78
D	iLOFT MONITOR	41
	Installation des Monitors	42
	Verkabelung	44
	Technische Eigenschaften	44
	Verkabelungschema	45
	Programmierung des Monitors	46
	Funktionsweise	50
	Monitoreinstellungen	52
	Wartung (Reinigung)	78
P	MONITOR iLOFT	53
	Instalação do Monitor	54
	Ligações	56
	Características Técnicas	57
	Esquemas cablagem	58
	Programação do monitor	58
	Funcionamento	61
	Ajustes do monitor	64
	Manutenção (limpeza)	78

INDICE

IT MONITOR iLOFT	65
Installazione Monitor	66
Collegamenti	68
Specifiche tecniche	68
Schemi	69
Programmazione del monitor	70
Funzionamento	73
Regolazione del monitor	76
Manutenzione (pulizia)	78

E *Monitor iLOFT*

EN *iLOFT Monitor*

F *Moniteur iLOFT*

D *iLOFT Monitor*

P *Monitor iLOFT*

IT *Monitor iLOFT*

INSTALACIÓN MONITOR EMPOTRAR

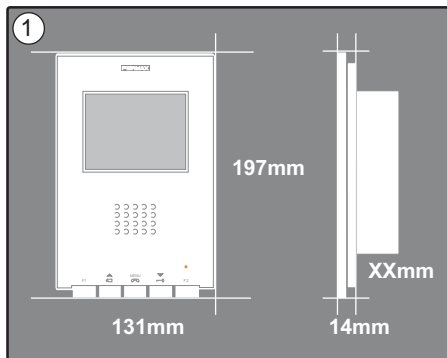

Dimensiones monitor (Alto x Ancho x Prof *):

197 x 131 x 60 mm / 7,7" x 5,1" x 2,3"

Dimensiones monitor modelo Pure (Alto x Ancho x Prof *):

197 x 131 x 59 mm / 7,7" x 5,1" x 2,3"

Dimensiones caja Fermax (Alto x Ancho x Prof.):

158 x 108 x 45 mm / 6,2" x 4,2" x 1,7"

Dimensiones caja universal (Alto x Ancho x Prof.):

174 x 114 x 50 mm / 6,8" x 4,5" x 2"

Notas:

- este monitor se puede instalar en una caja universal.
- **Prof ***: la profundidad del Monitor se ha considerado con caja Fermax

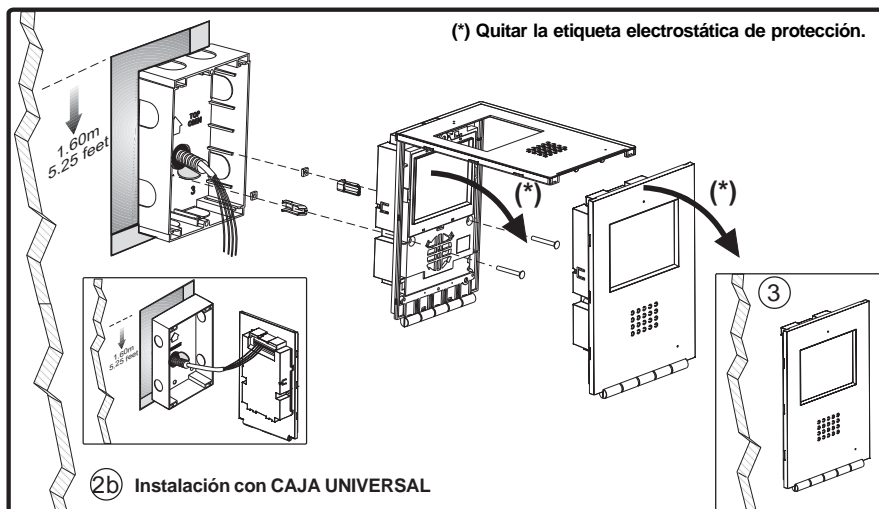
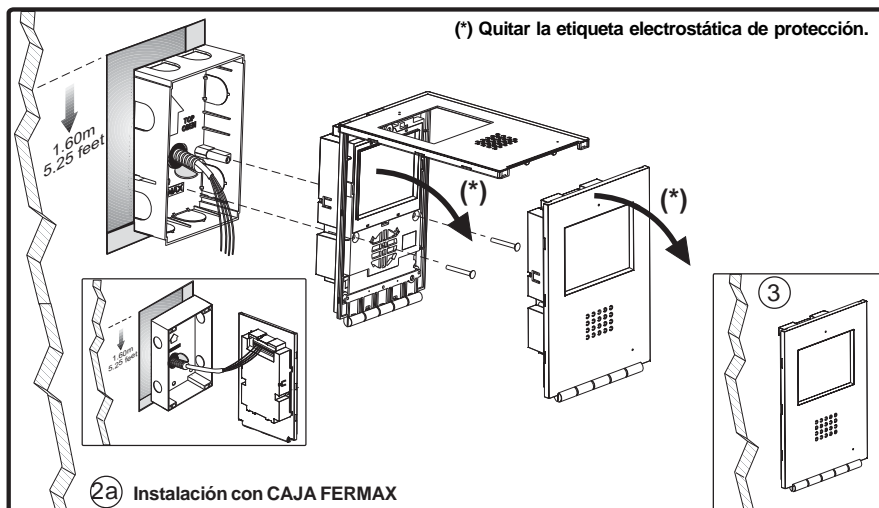

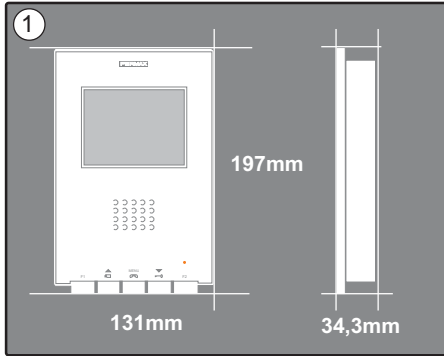
INSTALACIÓN MONITOR SUPERFICIE

Dimensiones monitor (Alto x Ancho x Prof.):
197 x 131 x 34,3 mm / 7,7" x 5,1" x 1,3"

Dimensiones monitor modelo Pure (Alto x Ancho x Prof.):
197 x 131 x 33,3 mm / 7,7" x 5,1" x 1,3"

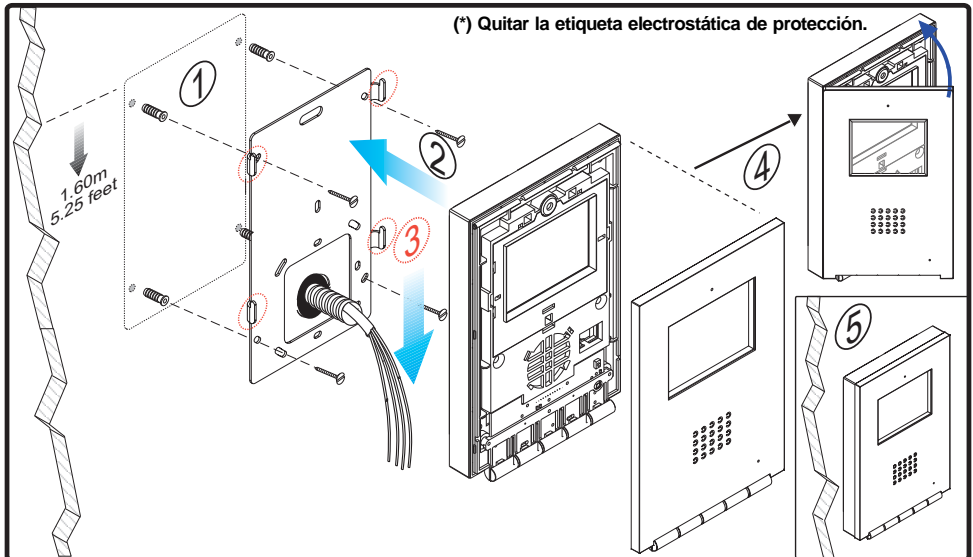

CONEXIONES

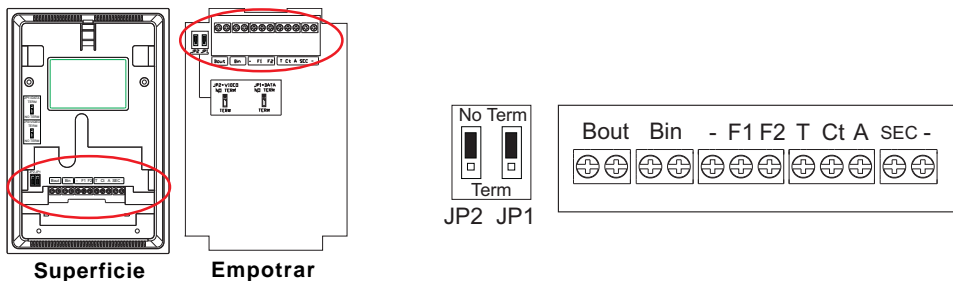

Bin	- Bus de comunicaciones audio+video (sin polaridad) - Conexión monitor/teléfono adicional
Bout	Conexión siguiente monitor/teléfono en cascada
F1, F2	Funciones adicionales (salida negativo «-»). Corriente máxima por pulsador F1,F2: 150mA
T, -	Conexión pulsador de llamada puerta vivienda.
CT	Cuando en el monitor se activa el video en esta borna se genera una tensión de 10Vdc (Activación cámara auxiliar).
A, -	Conexión prolongador de llamada Ref. 2040.
SEC	Genera una tensión de 12Vdc durante 5 segundos cuando se recibe una llamada en el monitor.

JP1	En <i>instalaciones en cascada</i> : - Colocar el puente JP1 en la posición NO TERM en los monitores de planta primera y plantas intermedias. - Colocar el puente JP1 en la posición TERM en el último monitor (última planta). En <i>instalaciones en distribución</i> , colocar el puente JP1 en la posición NO TERM en todos los monitores.
JP2	- Cuando sólo hay un monitor por vivienda, colocar el puente JP2 en la posición «NO TERM». - Si tenemos dos monitores (o incluso monitor y teléfono), se debe situar el puente JP2 en la posición «TERM» en ambos terminales.

CARACTERÍSTICAS TÉCNICAS

	Alimentación	24 Vdc		
	Consumo	SIN bucle inductivo	CON Bucle inductivo	
		en reposo	36 mA	34 mA
		en llamada	350 mA	490 mA
		con video	250 mA	330 mA
	con audio y video	390 mA	con audio al máximo 634 mA	
Temperatura de funcionamiento	[5, +40 °C] [41, +104 °F]			
Humedad	[0 - 90%]			
TFT	Pantalla Plana . 3,5" Diagonal			
Resolución:	Horizontal: 480 Line TV - Vertical: 234 Line TV			
Señal de video:	Señal modulada 4,5 Vpp			
Dimensiones monitor empotrar (Alto x Ancho x Prof.):	197 x 131 x 60 mm / 7,7" x 5,1" x 2,3"			
Dimensiones monitor empotrar Pure (Alto x Ancho x Prof.):	197 x 131 x 59 mm / 7,7" x 5,1" x 2,3"			
Dimensiones monitor superficie (Alto x Ancho x Prof.):	197 x 131 x 34,3 mm / 7,7" x 5,1" x 1,3"			
Dimensiones monitor superficie Pure (Alto x Ancho x Prof.):	197 x 131 x 33,3 mm / 7,7" x 5,1" x 1,3"			

ESQUEMAS

En cascada

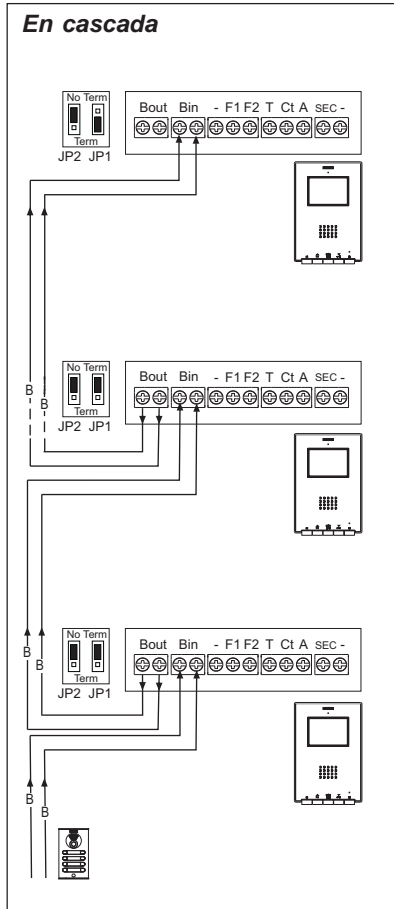

En distribución

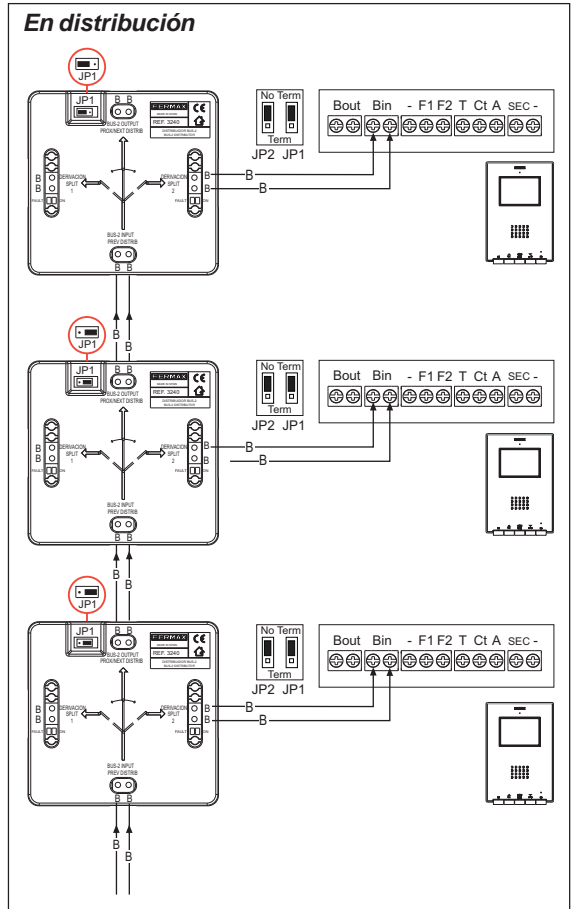

Monitor adicional

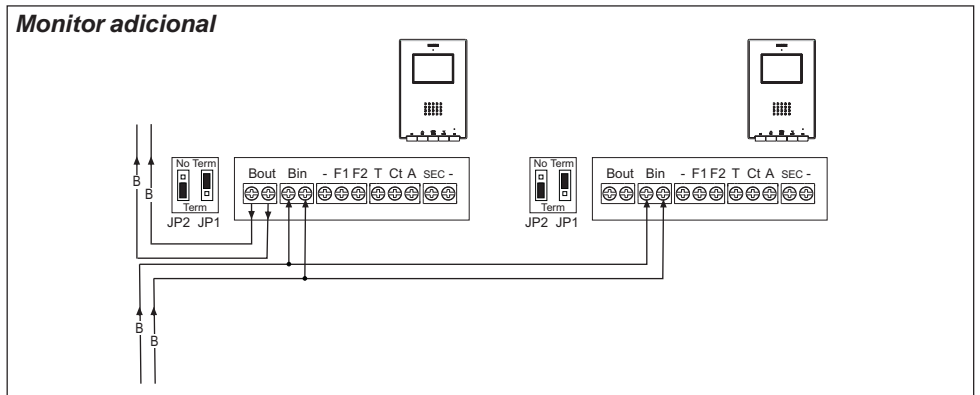

Nota: Configurar los puentes JP1 y JP2 tal y como se explica en la página anterior.

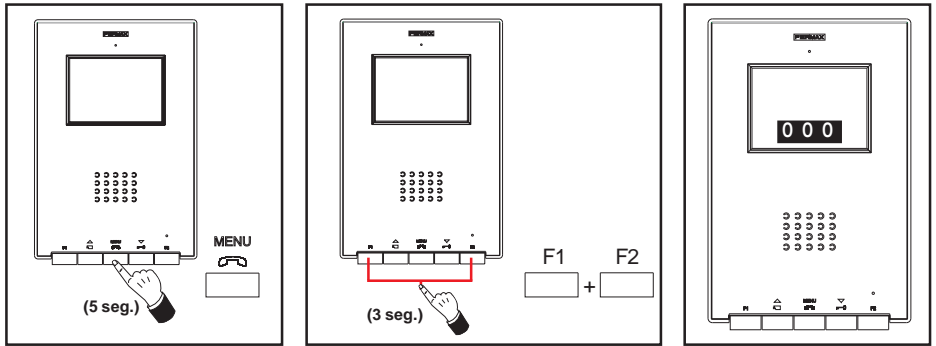
PROGRAMACIÓN DEL MONITOR iLOFT**1º. Entrar en programación****Opción 1**

Con el monitor conectado:

- Pulsar el botón «MENU» durante 5 segundos. Se escucha la melodía programada para la placa principal.
- Pulsar los botones «F1» y «F2» simultáneamente durante 3 segundos. Se escucha un pitido de confirmación, la pantalla del monitor se activa y se muestra en un recuadro la dirección actual del monitor.

El led azul fijo.

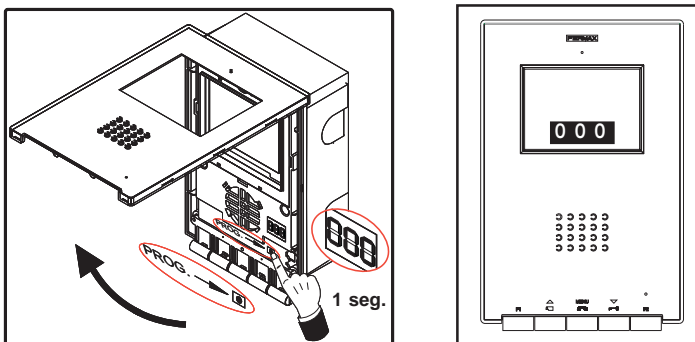
Opción 2

Con el monitor conectado:

- Presionar el botón «PROG.» durante 1 segundo. La pantalla del monitor se activa y se muestra en un recuadro la dirección actual del monitor.

El led azul fijo.

2º. Programar la dirección del monitor

Opción 1: Desde placa de calle

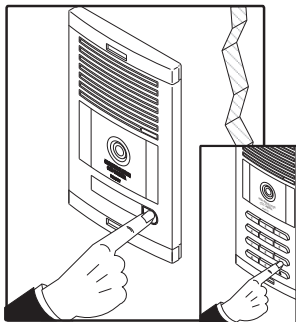

Pulsar el botón de llamada a vivienda (placas de pulsadores) o código de llamada (placas de teclado). Se produce confirmación con tono de llamada y se visualiza en la pantalla el número programado.

Opción 2: Desde monitor

2.1- Pulsar el botón correspondiente a centenas, decenas o unidades, para incrementar en una unidad el dígito correspondiente (se visualiza en pantalla):

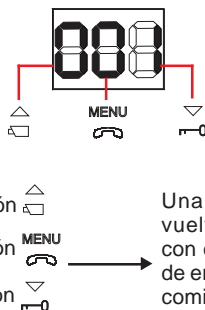
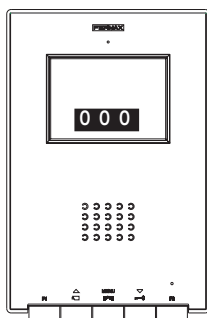

Centenas: Pulsar el botón

Decenas: Pulsar el botón

Unidades: Pulsar el botón

Una vez se llega al 9 y se vuelve a presionar continúa con el 0 y emite un tono grave de error. La siguiente pulsación comienza desde el número 1.

2.2- Confirmar la dirección: pulsar los botones «F1» y «F2» simultáneamente durante 3 segundos hasta escuchar un pitido de confirmación.

Si transcurren 90 segundos sin confirmar la dirección seleccionada, el monitor se queda programado con la dirección que tuviera programada antes de entrar en programación.

PROGRAMACIÓN DEL MONITOR iLOFT como SECUNDARIO

1º. Entrar en programación

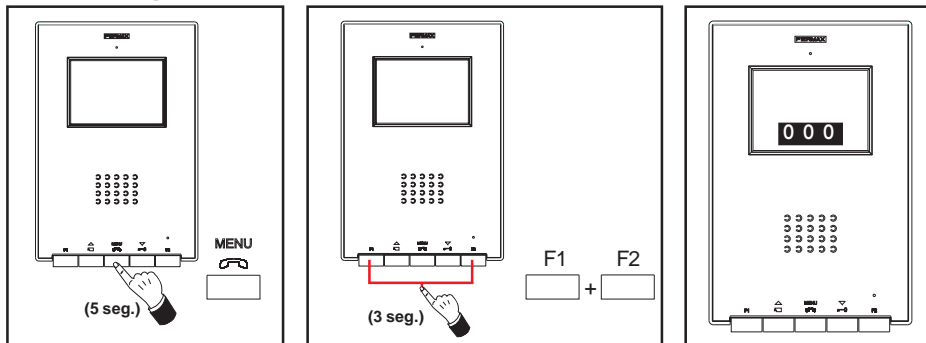

Con el monitor conectado:

- Pulsar el botón «MENU» durante 5 segundos. Se escucha la melodía programada para la placa principal.
- Pulsar los botones «F1» y «F2» simultáneamente durante 3 segundos. Se escucha un pitido de confirmación, la pantalla del monitor se activa y se muestra en un recuadro la dirección actual del monitor.

El led azul fijo.

2º. Programar la dirección del monitor , desde el monitor

2.1- Pulsar el botón correspondiente a centenas, decenas o unidades, para incrementar en una unidad el dígito correspondiente (se visualiza en pantalla):

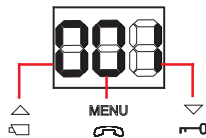
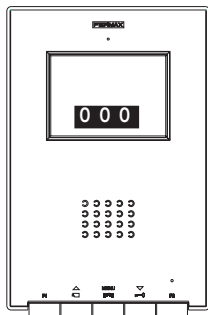

- Centenas: Pulsar el botón
- Decenas: Pulsar el botón
- Unidades: Pulsar el botón

Una vez se llega al 9 y se vuelve a presionar continúa con el 0 y emite un tono grave de error. La siguiente pulsación comienza desde el número 1.

2.2- Pulsar el botón «F2», hasta escuchar sonido de confirmación.

2.3- Confirmar la dirección: pulsar los botones «F1» y «F2» simultáneamente durante 3 segundos hasta escuchar un pitido de confirmación.

Si transcurren 90 segundos sin confirmar la dirección seleccionada, el monitor se queda programado con la dirección que tuviera programada antes de entrar en programación.

FUNCIONAMIENTO MONITOR ILOFT

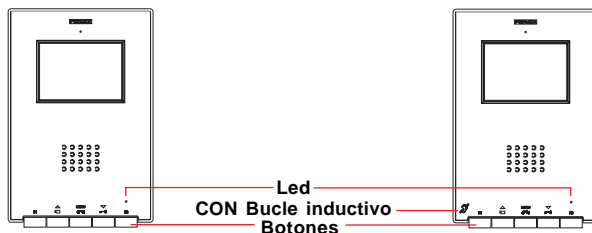

CON Bucle inductivo. Vienen identificados con este símbolo.

- Incluye un bucle que interactúa con los dispositivos de audición de personas con discapacidad auditiva.
- **Nota:** en dispositivos de audición con selección manual de modo, debe estar configurado el Modo Digital.

Botones

MENU



Botón Activación de Audio, Colgado y Ajustes configuración (menú).

- Al recibir una llamada pulsar este botón para hablar con el visitante. Se abre el canal de audio en sentido calle y vivienda, el funcionamiento es en modo manos libres.
- Pulsar al finalizar la comunicación.
- Con el monitor en reposo pulsar este botón, durante 3 segundos, para entrar en modo configuración del monitor. Ver apartado «Ajustes del Monitor».



F0



Botón de abrepuertas / llamada a conserje.

- Estando en conversación con la Placa de Calle, al pulsar este botón se activa el abrepuertas.
- Con el monitor en reposo, al pulsar este botón se realiza una llamada al conserje (si existe conserjería).



Botón de Autoencendido / Selección cámara principal-secundaria.

- Con el monitor en reposo pulsar este botón durante 1 segundo para encender manualmente el monitor. Para activar audio pulsar el botón .
- Con video, mantener pulsado este botón durante 2 segundos para seleccionar secuencialmente entre la cámara principal y secundaria (si existe).

F1



F1 y F2: Botones para Funciones Adicionales. (Asignadas por el instalador).

Led

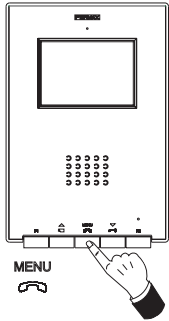

	Estado Led	Estado monitor
Rojo	Parpadeo 1 vez cada segundo.	En modo programación.
	Parpadeo 1 vez cada 2 segundos.	Cancelación tono de llamada activado.
Verde	Encendido color verde.	Modo «Apertura automática» activado.
Verde Rojo	Encendido, alterna entre verde y rojo.	Cancelación tono de llamada y Modo «Apertura automática» activados.
Azul	Encendido color azul.	Comunicación establecida / Canal ocupado y ajustes.

Funcionamiento



Atender una llamada

Al presionar el pulsador de llamada, en la **Placa de Calle** se produce un tono de llamada tanto en la placa de calle como en el monitor, encendiéndose la pantalla.

Pulsar el botón  para hablar con el visitante. Se abre el canal de audio en sentido calle y vivienda, el **funcionamiento es en modo manos libres**. La comunicación finalizará automáticamente a los 90 segundos o en cualquier momento al pulsar el botón  **MENU**.

El led permanecerá encendido (azul) durante el tiempo que dure la conversación.

Si no se establece comunicación con la placa de calle, el monitor se apaga automáticamente pasados 30 seg.

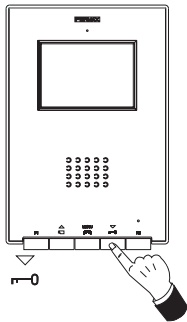

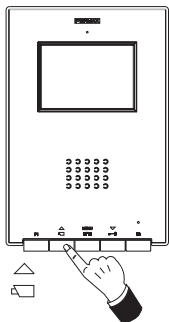

Apertura de puerta

Al recibir una llamada desde la placa de calle, es posible abrir la puerta en cualquier momento, pulsado el botón .



Activación Manual del Monitor (Autoencendido)

Con el monitor en reposo pulsar este botón  durante 1 segundo para encender manualmente el monitor. Para seleccionar secuencialmente entre la cámara principal y secundaria (si existe) mantener pulsado el botón  durante 2 segundos.

Para activar el audio y hablar con el visitante o abrir la puerta realizar los pasos descritos anteriormente.

Si no se establece comunicación con la placa de calle, el monitor se apaga automáticamente pasados 30 seg.

NOTAS:

La pantalla del monitor se enciende una vez finalizada la llamada desde placa.

Si existe más de un monitor iLoft en la instalación y se realiza la llamada a un monitor, el resto de los monitores mostrarán el led en color azul avisando que el canal está ocupado.

Funcionamiento

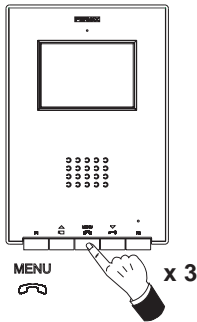

Cancelar tono de llamada

Con el monitor en reposo, pulsar 3 veces seguidas el botón  en un tiempo inferior a 2 segundos aproximadamente.

El led rojo parpadea 1 vez cada 2 segundos.

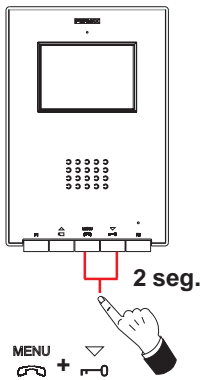

Para desactivar la cancelación de tono de llamada, pulsar nuevamente 3 veces seguidas el botón  en un tiempo inferior a 2 segundos.

El led vuelve a sus estado anterior.





Modo «Apertura automática»

Con el modo «Apertura automática» activado, el monitor activa automáticamente el abrepuertas a los 5 segundos de recibir una llamada desde placa.

Para activar el modo «Apertura automática» pulsar simultáneamente, durante 2 segundos, los botones  + .

El led permanece en color verde.

Para desactivar el modo «Apertura automática» pulsar simultáneamente, durante 2 segundos, los botones  + .

El led vuelve a sus estado anterior.

Nota: Si al mismo tiempo están activadas la «cancelación del tono de llamada» y la «apertura automática», el led del monitor alternará entre rojo y verde cada segundo.

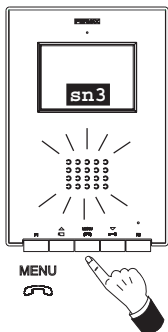

Ajuste Volumen Audio



Estando en comunicación con placa de calle, mantener pulsado el botón , hasta que aparezca en pantalla el menú:

sn 3

- pulsar el botón  para aumentar el *nivel de audio*.

- pulsar el botón  para disminuir el *nivel de audio*.

(Existen 5 niveles seleccionables de audio: sn1..sn5)

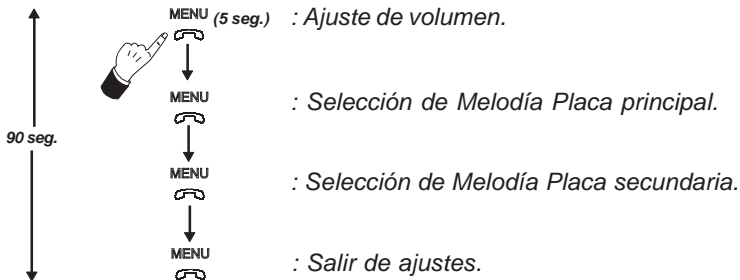

Es posible establecer comunicación con la placa de calle sin necesidad de recibir una llamada de placa, realizando «Autoencendido» (pulsar ) y pulsando posteriormente el botón .

AJUSTES MONITOR iLOFT

Ajustes de Volumen y Selección de Melodías

- **Acceso a modo «ajuste de volumen»:** pulsar el botón «» 5 segundos. (el led parpadea 1 vez por segundo y se escuchar el tono de llamada de placa principal).

El monitor iLOft dispone de 5 niveles de volumen distintos:



- pulsar el botón  para aumentar el volumen.
- pulsar el botón  para disminuir el volumen.

Una vez se alcanza el mayor o menor de los niveles de volumen se escucha un pitido doble indicando que se ha alcanzado el nivel máximo o mínimo.

- **Acceso a modo «selección de melodía»**



Melodía para llamada procedente de Placa Principal:

Estando en modo «ajuste de volumen» pulsar el botón «» hasta escuchar nuevamente el tono de llamada de placa principal.

- pulsar el botón  para seleccionar la melodía siguiente.
- pulsar el botón  para seleccionar la melodía anterior.

Melodía para llamada procedente de Placa Secundaria:

Estando en modo «selección de melodía para Placa Principal» pulsar el botón «» hasta escuchar nuevamente el tono de llamada de placa principal.

- pulsar el botón  para seleccionar la melodía siguiente.
- pulsar el botón  para seleccionar la melodía anterior.

- **Salir de «ajuste de volumen y selección de melodía»**

Estando en modo «selección de melodía para Placa Secundaria» pulsar el botón «» hasta escuchar un tono largo de confirmación.

Ajustes de Imagen (contraste, brillo, color)

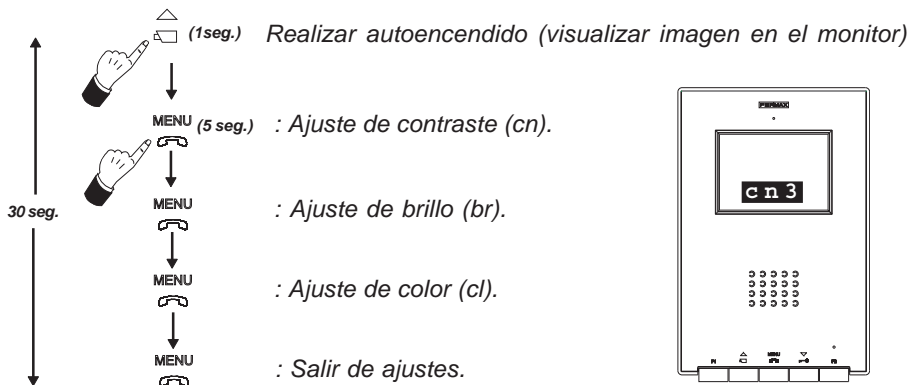

El monitor ILOFT, dispone de 5 niveles predefinidos para los ajustes de contraste, brillo y color.

- Acceso a modo «ajuste de contraste»:

- 1- Realizar autoencendido: Pulsar el botón hasta visualizar la imagen en la pantalla.
- 2- pulsar el botón «» 5 segundos.

Se escucha un pitido de confirmación y se muestra en pantalla el menú de ajuste de contraste.



- pulsar el botón para aumentar el *nivel de contraste*.
- pulsar el botón para disminuir el *nivel de contraste*.

- Acceso a modo «ajuste de brillo»:

Estando en modo «ajuste de contraste» pulsar el botón «»:



- pulsar el botón para aumentar el *nivel de brillo*.
- pulsar el botón para disminuir el *nivel de brillo*.

- Acceso a modo «ajuste de color»:

Estando en modo «ajuste de brillo» pulsar el botón «»:



- pulsar el botón para aumentar el *nivel de color*.
- pulsar el botón para disminuir el *nivel de color*.

- Salir de «ajuste de imagen»: Estando en modo «ajustes de color» pulsar el botón «».

Nota: Si el monitor se apaga porque han transcurrido los 30 segundos de programación, se guardan los últimos valores mostrados en pantalla para cada ajuste.

FLUSH MOUNTED MONITOR INSTALLATION

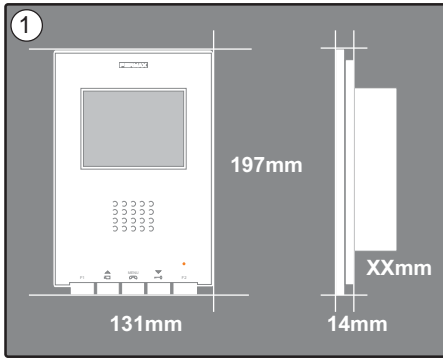

Monitor Dimensions (Height x Width x Depth*.):

197 x 131 x 60 mm / 7.7" x 5.1" x 2.3"

Pure Monitor Dimensions (Height x Width x Depth*.):

197 x 131 x 59 mm / 7.7" x 5.1" x 2.3"

Fermax Box Dimensions (Height x Width x Depth):

158 x 108 x 45 mm / 6.2" x 4.2" x 1.7"

Universal Box Dimensions (Height x Width x Depth):

174 x 114 x 50 mm / 6.8" x 4.5" x 2"

Note:

- this Monitor can be installed in a universal box.
- **Depth ***: the Monitor depth stated here takes into account the Fermax box

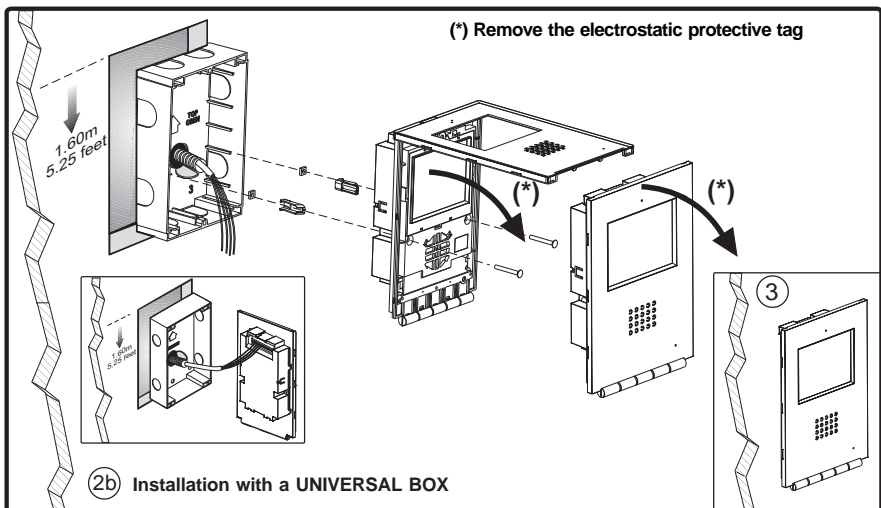
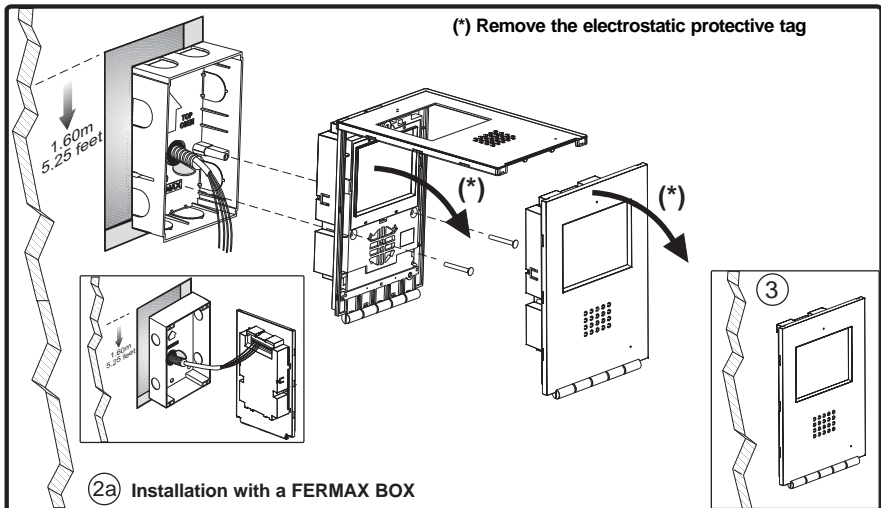

SURFACE MONITOR INSTALLATION

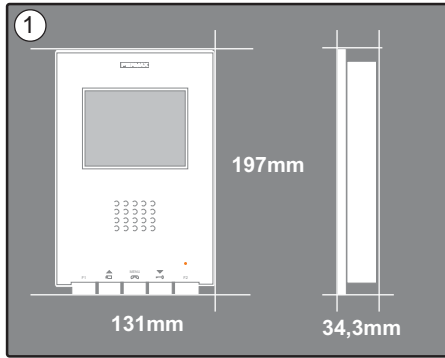

Monitor Dimensions (Height x Width x Depth.):
197 x 131 x 34,3 mm / 7,7" x 5,1" x 1,3"

Pure Monitor Dimensions (Height x Width x Depth.):
197 x 131 x 33,3 mm / 7,7" x 5,1" x 1,3"

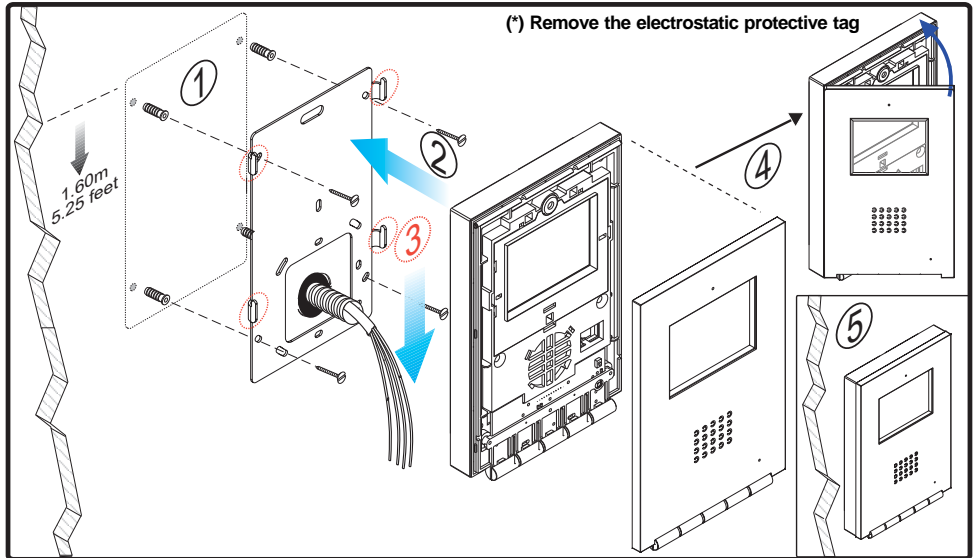

CONNECTIONS

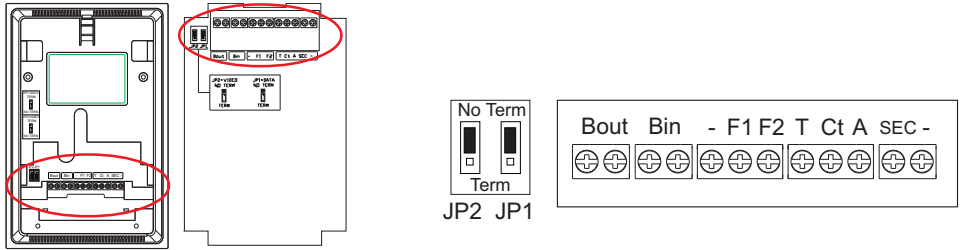

	Surface	Flush
Bin	- Audio + Video Communication Bus (polarity free) - Monitor/Additional Telephone Connection	
Bout	Connection to next monitor/telephone on the cascade.	
F1, F2:	Additional Functions (negative output «-») Maximum current per F1 and F2 button: 150mA	
T, -:	Call Button Connection for Doors to Residences.	
CT	When the video is activated from this terminal on the monitor, it generates a voltage of 10Vdc (Auxiliary Camera Activation).	
A, -	Call Extension Connection Ref. 2040.	
SEC	Generates a voltage of 12Vdc for a period of 5 seconds when a call is received on the monitor.	
JP1:	In <i>cascade systems</i> : - Set up the JP1 switch in the NO TERM position on the first and mezzanine floor monitors. - Set up the JP1 switch in the TERM position on the last monitor (top floor). In distribution systems, set up the JP1 switch in the NO TERM position on all the monitors.	
JP2 :	- When there is only one monitor per residence, set up the JP2 switch in the NO TERM position. - If we have two monitors (or even a monitor and a telephone) the JP2 switch should be set up in the TERM position on both terminals.	

TECHNICAL FEATURES

	Power Supply	24 Vdc		
	Consumo	WITHOUT Induction Loop	WITH Induction Loop	
		on standby	36 mA	34 mA
		making a call	350 mA	490 mA
		with video	250 mA	330 mA
	with audio and video	390 mA	with audio at maximum 634 mA	
Operating Temperature	[5 , +40 °C] [41, +104 °F]			
Humidity	[0 - 90%]			
TFT	Flat Screen. 3,5 Diagonal			
Resolution:	Horizontal: 480 Line TV - Vertical: 234 Line TV			
Video Signal:	4.5Vpp Modulated Signal			
Flush mounted monitor dimensions (Height x Width x Depth):	197 x 131 x 60 mm / 7,7" x 5,1" x 2,3"			
Pure flush mounted monitor dimensions (Height x Width x Depth):	197 x 131 x 59 mm / 7,7" x 5,1" x 2,3"			
Surface monitor dimensions (Height x Width x Depth):	197 x 131 x 34,3 mm / 7,7" x 5,1" x 1,3"			
Pure surface monitor dimensions (Height x Width x Depth):	197 x 131 x 33,3 mm / 7,7" x 5,1" x 1,3"			

DIAGRAMS:

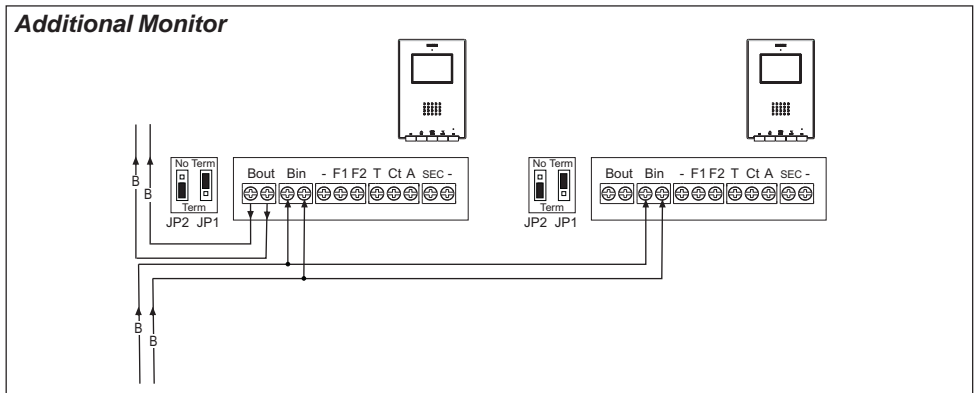
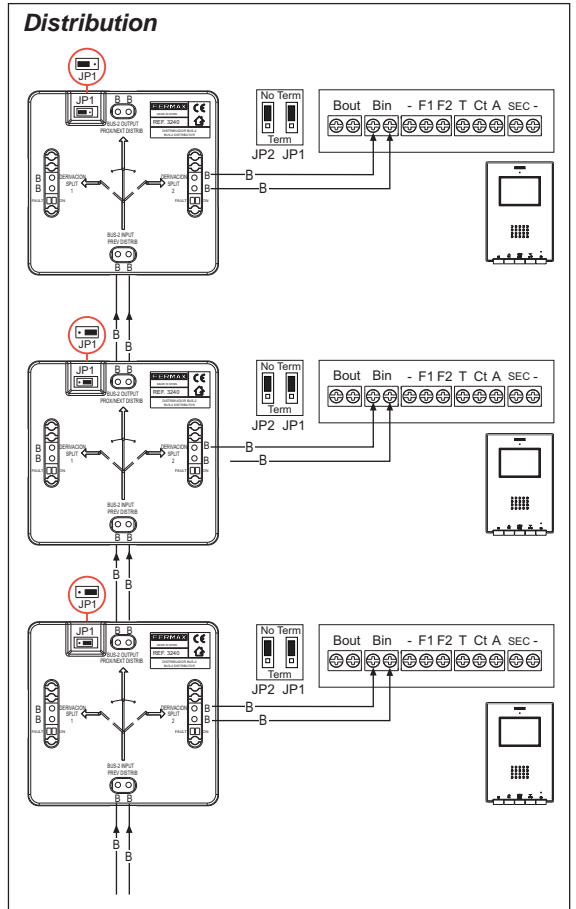
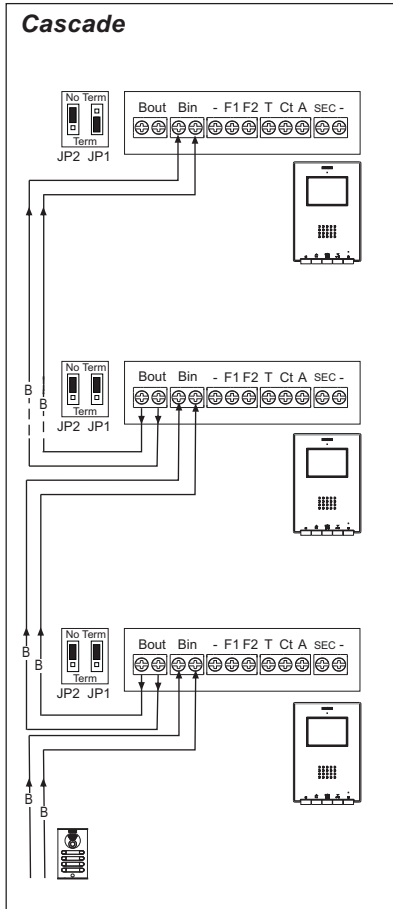

Note: Configure the JP1 and JP2 switches as explained on the previous page.

PROGRAMMING THE iLOFT MONITOR

1. Select programming mode:

Option 1:

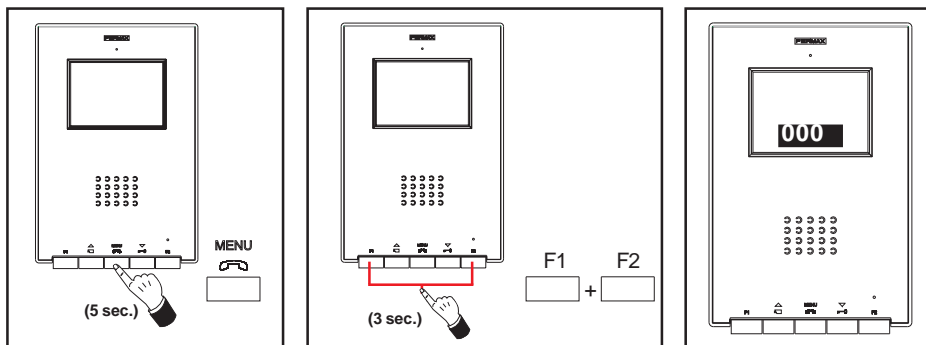

With the monitor connected:

- Press and hold the «MENU» button for 5 seconds. The tone pre-programmed on the main panel will sound.
- Press and hold the «F1» and «F2» buttons simultaneously for 3 seconds. The confirmation tone will sound, the monitor screen will be activated and will show its current address in the box.

The blue led on.

Option 2:

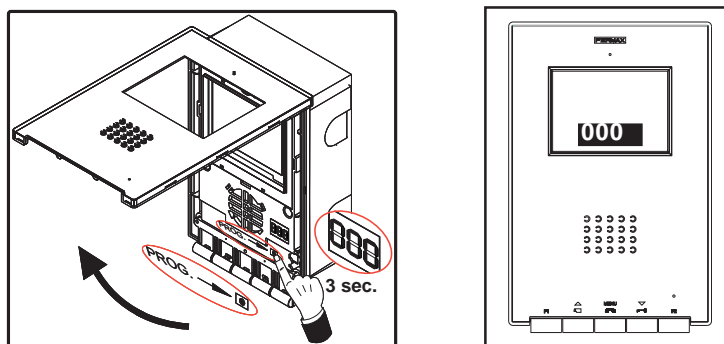

With the monitor connected:

- Press and hold the «PROG» button for 1 second. The monitor's screen will be activated and show its current address in the box.

The blue led on.

2. Programme the monitor's address

Option 1: From the entry panel

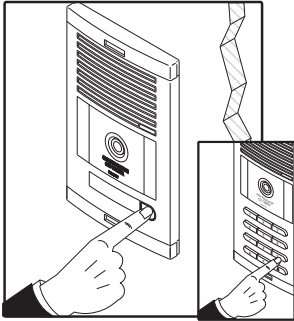



Press the residence's call button (button panel) or call code (keypad panel). A ring tone will sound as confirmation and you will see the number programmed appear on the screen.

Option 2: From the Monitor

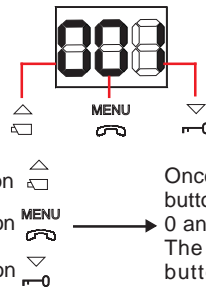
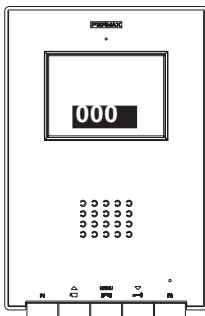
2.1- Press the corresponding button for hundreds, tens or units to increase the corresponding digit by that unit (appears on screen):



Hundreds: Press the button 
 Tens: Press the button 
 Units: Press the button 

Once you reach 9 pressing the button again will return you to 0 and an error tone will sound. The next time you press the button it will start from the number 1.

2.2- Confirm address: press and hold the «F1» and «F2» buttons simultaneously for 3 seconds until you hear the confirmation tone.

If 90 seconds elapse without you having confirmed the selected address, the monitor will remain programmed with the last address stored before entering programming mode.

PROGRAMMING OF THE iLOFT MONITOR as a SECONDARY

1. Select programming mode:

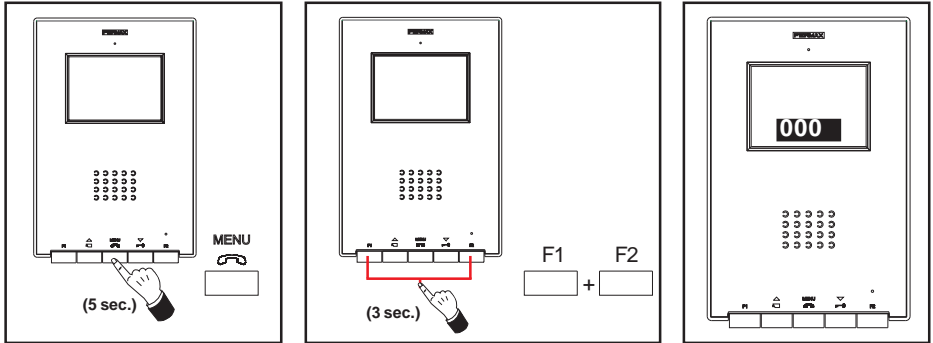

With the monitor connected:

- Press and hold the «MENU» button for 5 seconds. The tone pre-programmed on the main panel will sound.
- Press and hold the «F1» and «F2» buttons simultaneously for 3 seconds. The confirmation tone will sound, the monitor screen will be activated and will show its current address in the box.

The blue led on.

2. Programme the monitor's address from the Monitor

2.1- Press the corresponding button for hundreds, tens or units to increase the corresponding digit by that unit (appears on screen):

Hundreds: Press the button

Tens: Press the button

Units: Press the button

Once you reach 9 pressing the button again will return you to 0 and an error tone will sound. The next time you press the button it will start from the number 1.

2.2- Press the «F2» button until you hear the confirmation sound.

2.3- Confirm address: press and hold the «F1» and «F2» buttons simultaneously for 3 seconds until you hear the confirmation tone.

If 90 seconds elapse without you having confirmed the selected address, the monitor will remain programmed with the last address stored before entering programming mode.

iLOFT MONITOR OPERATION

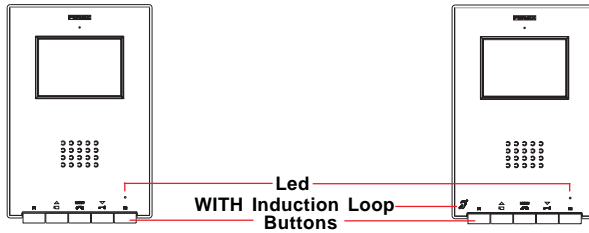

Including induction loop. Identified by the following symbol.

- Includes an induction loop which interacts with audio devices used by the hearing impaired.
- **Note:** In manual audio devices Digital Mode should be configured.

Buttons



Audio Activation, Call Hang-Up and Configuration Settings Button (menu).

- When a call is received, press this button to speak to the visitor. The audio channel between the entry panel and the residence is opened; operating in hands-free mode.
- Press to end communication.
- With the monitor on standby, press and hold this button for 5 seconds to go into monitor configuration mode. See the «Monitor Settings» section.



Lock Release / Call Guard Unit Button

- Pressing this button whilst communicating with the Entry Panel will activate the *lock release*.
- Pressing this button whilst the monitor is on standby will result in a *call being made to the guard unit* (where one exists).



Auto-Start / Main-Secondary Camera Selection Button.

- With the monitor on standby, press and hold this button for 1 second to switch the monitor on manually. To activate audio functions, press the  button.
- With video, press and hold this button for 2 seconds to sequentially select between the main camera and the secondary camera (where one exists).



F1 and F2: Buttons for Additional Functions. (Assigned by the installer).

Led

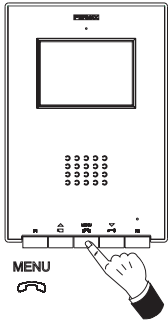

	Led Status	Monitor Status
Red	1 Flash every second.	In Programming Mode.
	1 Flash every 2 seconds.	Ring Tone Cancelled Option Activated.
Green	On, green .	«Automatic Release» Mode Activated.
Green Red	On, alternating between green and red.	Call Tone Cancelled and «Automatic Release» activated.
Blue:	On, blue .	Communication Established / Channel Busy and Settings.

Operation



Answering a call.

When the call button on the **Entry Panel** is pressed a ring tone is emitted both from the panel and on the monitor, causing the screen to start up.

Press the button ^{MENU}  to speak with the visitor. The audio channel between the entry panel and the residence will be opened; **operating in hands-free mode**. The communication will automatically end after 90 seconds, or at any time by pressing the ^{MENU}  button .

The led will remain on (blue) for the duration of the conversation.

If communication is not established with the entry panel, the monitor will automatically switch off after 30 seconds.

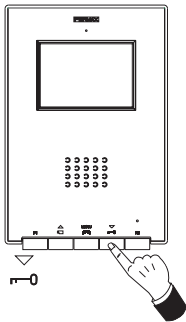

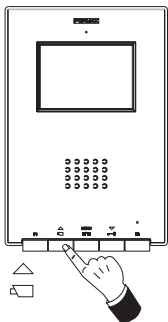

Opening the Door

When a call is received from the entry panel, you can open the door at any time, by pressing the  button.



Manual Monitor Activation (Auto-Start)

With the monitor on standby, press and hold the  button for 1 second to switch the monitor on manually. To sequentially select between the main camera and the secondary camera (where one exists), press and hold the  button for 2 seconds.

To activate the audio and speak to the visitor or open the door, follow the steps above.

If communication is not established with the entry panel, the monitor will automatically switch off after 30 seconds.

NOTES:

The monitor screen goes on once the call from the panel has ended.

If there is more than one iLoft monitor in the system and a call is made to one of the monitors, the rest of the monitors will show a blue led, warning that the channel is busy.

Operation

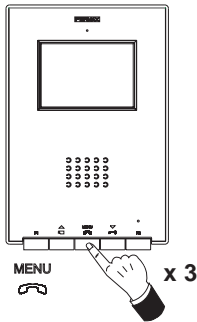

Canceling the Ring Tone

With the monitor on standby, press the  button 3 times consecutively in less than 2 seconds.

The red led flashes once every 2 seconds.

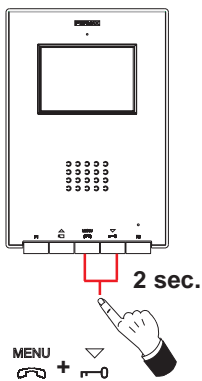

To deactivate the ring tone cancellation option, press the  button 3 times consecutively once again, in less than 2 seconds.

The led will return to its previous status.





«Automatic Release» Mode

When «Automatic Release» Mode is activated, the monitor will automatically be activated 5 seconds after receiving a call from the panel.

To activate the «Automatic Release» Mode, press and hold the  +  buttons simultaneously for 2 seconds.

The led remains green.

To deactivate the «Automatic Release» Mode, press and hold the  +  buttons simultaneously for 2 seconds.

The led will return to its previous status.

Note: If the «Cancel Ring Tone» and «Automatic Release» Mode are activated at the same time, the monitor led will alternate between red and green every second.

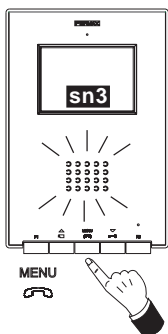

Audio Volume Settings



While communicating with the entry panel, press and hold the  button, until the menu appears on the screen.

sn3

- press the  button to increase the *audio volume*.

- press the  button to reduce the *audio volume*.

(There are 5 possible audio options: sn1..sn5)

You can communicate with the entry panel without having received a call by selecting «Auto-Start» (pressing ) and then pressing the  button.

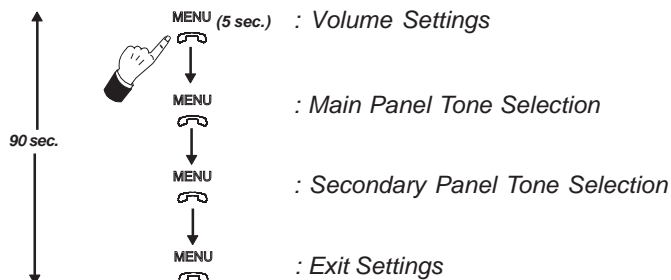

iLOFT MONITOR SETTINGS

Volume Settings and Tone Selection



- **Accessing «Volume Settings» Mode:** Press and hold the «» button for 5 seconds. (the led flashes once per second and the dial tone sounds via the main panel).

The iLOft monitor has 5 different volume levels:



- press the  button to increase the *volume*.
- press the  button to reduce the *volume*.

Once the lowest or highest volume levels have been reached a double beep will sound indicating that you reached the minimum or maximum levels.

- **Accessing «Tone Selection» Mode:**



Tone for calls coming from the Main Panel:

While in «volume settings» mode press the «» button until you hear the main panel ring tone again.

- press the  button to select the next ring tone.
- press the  button to select the previous ring tone.

Tone for calls coming from the Secondary Panel:

While in «Tone Selection Mode for the Main Panel» press the «» button until you hear the main panel ring tone again.

- press the  button to select the next ring tone.
- press the  button to select the previous ring tone.

- **Exit «volume settings and tone selection»**

While in «Tone Selection Mode for the Secondary Panel» press the «» button until you hear the long confirmation tone.

Image Settings (contrast, shine, colour)



The ILOFT monitor has 5 pre-defined levels for contrast, shine and colour settings.

- Accessing «Contrast Settings» Mode:

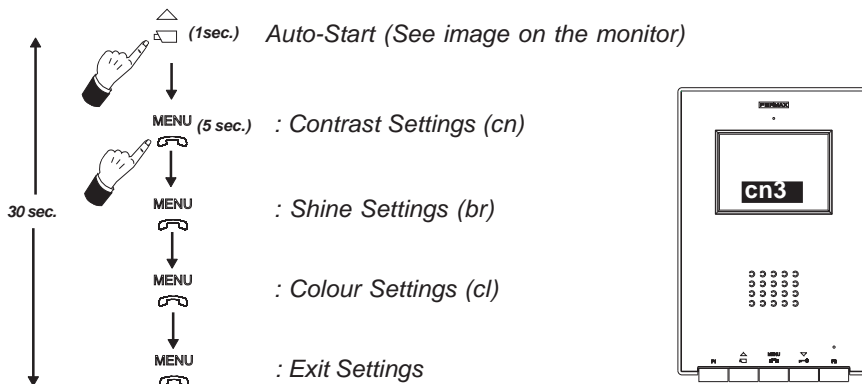
1 - Auto-Start: Press and hold the △ button until you see the image on the screen.

2- Press and hold the «MENU» button for 5 seconds.

You will hear a confirmation tone and the contrast settings menu will appear on the screen.



- press the △ button to increase the *contrast level*.

- press the ▽ button to reduce the *contrast level*.

- Accessing «Shine Settings» Mode:

While in «Contrast Settings» mode, press the «MENU» button:



- press the △ button to increase the *shine level*.

- press the ▽ button to reduce the *shine level*.

- Accessing «Colour Settings» Mode:

While in «Shine Settings» mode, press the «MENU» button:



- press the △ button to increase the *colour level*.

- press the ▽ button to reduce the *colour level*.

- Exit «Image Settings»: While in «Colour Settings» mode, press the «MENU» button:

Note: If the monitor switches off because 30 seconds have elapsed since you began programming, the most recent selection shown on screen for each setting will be saved.

INSTALLATION MONITEUR ENCASTRER

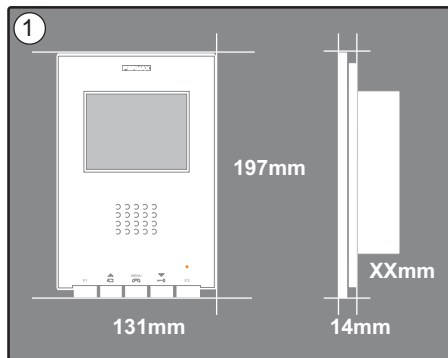

Dimensions moniteur (hauteur x largeur x prof*) :

197 x 131 x 60 mm / 7,7" x 5,1" x 2,3"

Dimensions moniteur Pure (hauteur x largeur x prof*) :

197 x 131 x 59 mm / 7,7" x 5,1" x 2,3"

Dimensions boîtier Fermax (hauteur x largeur x prof*) :

158 x 108 x 45 mm / 6,2" x 4,2" x 1,7"

Dimensions boîtier universel (hauteur x largeur x prof*) :

174 x 114 x 50 mm / 6,8" x 4,5" x 2"

Remarques :

- Ce moniteur peut être installé dans un boîtier universel.
- **Prof *** : la profondeur du moniteur est prise en compte avec le boîtier Fermax.

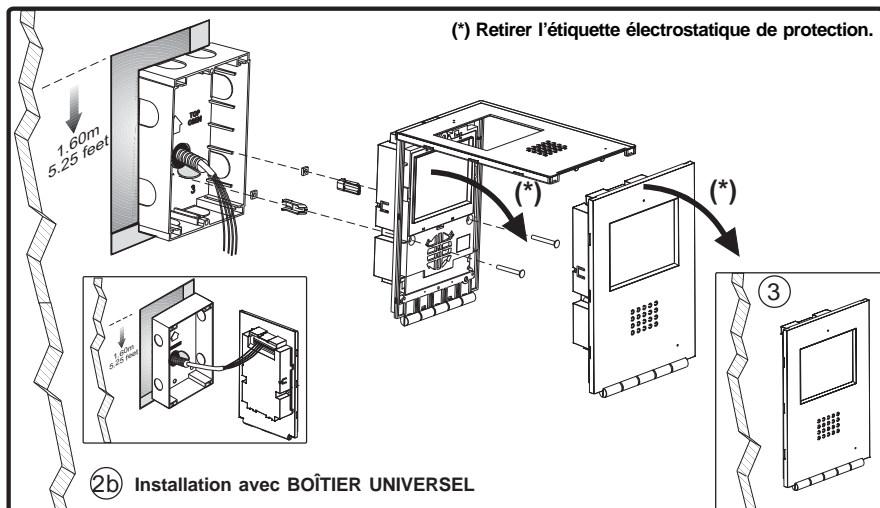
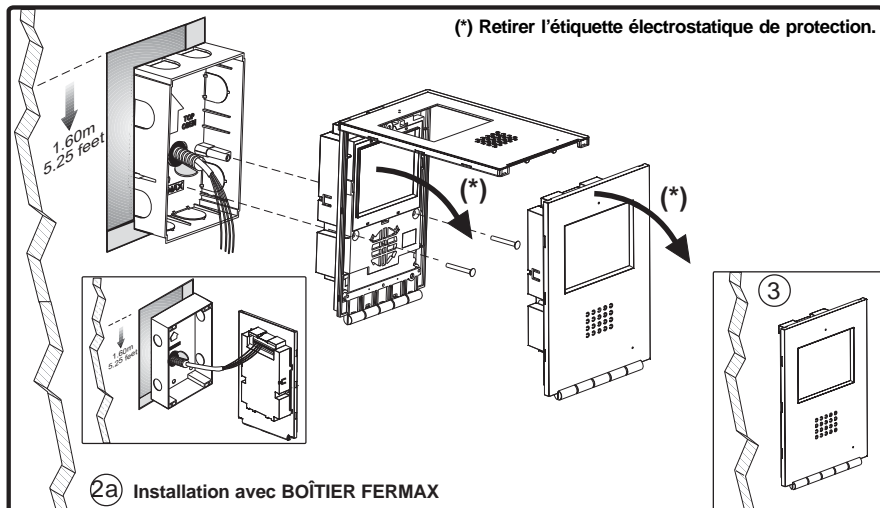

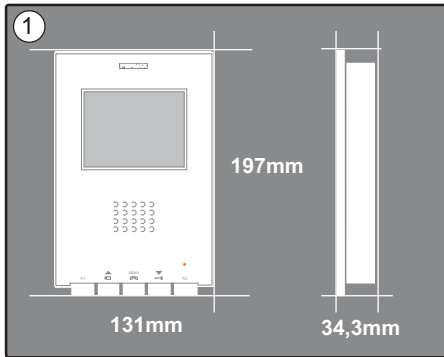
INSTALLATION MONITEUR SURFACE

Dimensions moniteur (hauteur x largeur x prof.):
197 x 131 x 34,3 mm / 7,7" x 5,1" x 1,3"

Dimensions moniteur Pure (hauteur x largeur x prof.):
197 x 131 x 33,3 mm / 7,7" x 5,1" x 1,3"

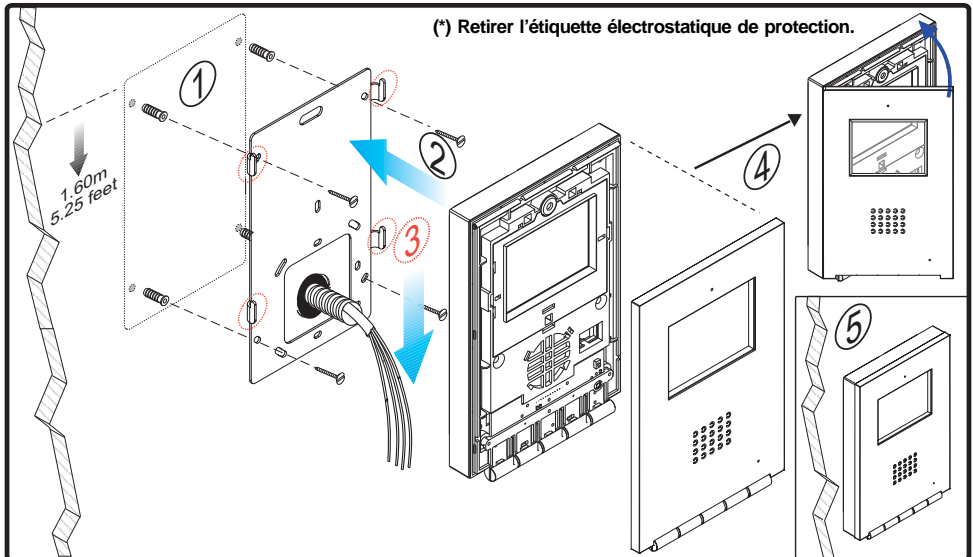

CONNEXIONS

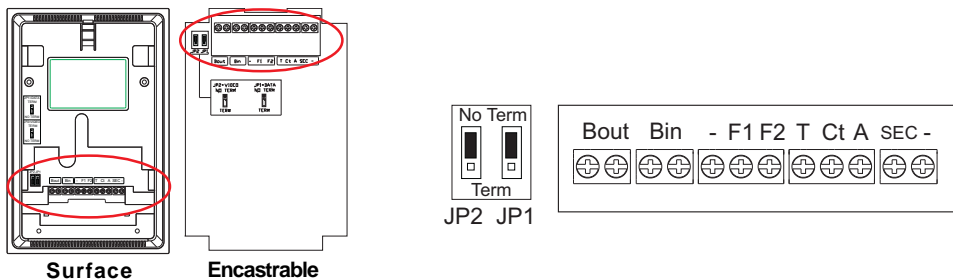

Bin	- Bus de communication audio+vidéo (sans polarité). - Connexion moniteur/poste supplémentaire.
Bout	Connexion moniteur/poste en cascade suivant.
F1, F2	Fonctions supplémentaires (sortie négatif « - »). Courant maximal par bouton-poussoir F1,F2 : 150 mA.
T, -	Raccordement bouton-poussoir d'appel de la porte du logement
CT	Lorsque l'image s'active sur le moniteur, une tension de 10 Vcc (activation caméra auxiliaire) est créée au niveau de cette borne.
A, -	Raccordement prolongateur d'appel réf. 2040.
SEC	Crée une tension de 12 Vcc pendant 5 secondes lors de la réception d'un appel au niveau du moniteur.

JP1	<p>Sur des <i>installations en cascade</i> :</p> <ul style="list-style-type: none"> - Placez le commutateur JP1 sur la position NO TERM sur les moniteurs du premier étage et des étages intermédiaires. - Placez le commutateur JP1 sur la position TERM sur le dernier moniteur (dernier étage). <p>Sur des <i>installations en distribution</i>, placez le commutateur JP1 sur NO TERM pour tous les moniteurs.</p>
JP2	<ul style="list-style-type: none"> - Lorsqu'il n'y a qu'un seul moniteur par logement, placez le commutateur JP2 sur « NO TERM ». - S'il y a deux moniteurs (voire moniteur et poste), l'on doit placer le commutateur JP2 sur « TERM » pour les deux terminaux.

CARACTÉRISTIQUES TECHNIQUES

	Alimentation	24 Vdc		
	Consommation	SANS Boucle à induction	AVEC Boucle à induction ⚡	
		en veille	36 mA	34 mA
		lors d'un appel	350 mA	490 mA
		avec image	250 mA	330 mA
	avec son et image	390 mA	avec son au maximum 634 mA	
Température de fonctionnement	[5 , +40 °C] [41, +104 °F]			
Humidité	[0 - 90%]			
TFT	Ecran plat. 3,5" Diagonal			
Résolution :	Horizontale : 480 Line TV / Verticale : 234 Line TV			
Signal vidéo :	signal modulé 4,5 Vpp			
Dimensions moniteur à encastrer (hauteur x largeur x prof.):	197 x 131 x 60 mm / 7,7" x 5,1" x 2,3"			
Dimensions moniteur à encastrer Pure (hauteur x largeur x prof.):	197 x 131 x 59 mm / 7,7" x 5,1" x 2,3"			
Dimensions moniteur en saillie (hauteur x largeur x prof.):	197 x 131 x 34,3 mm / 7,7" x 5,1" x 1,3"			
Dimensions moniteur en saillie Pure (hauteur x largeur x prof.):	197 x 131 x 33,3 mm / 7,7" x 5,1" x 1,3"			

SCHÉMAS

En cascade

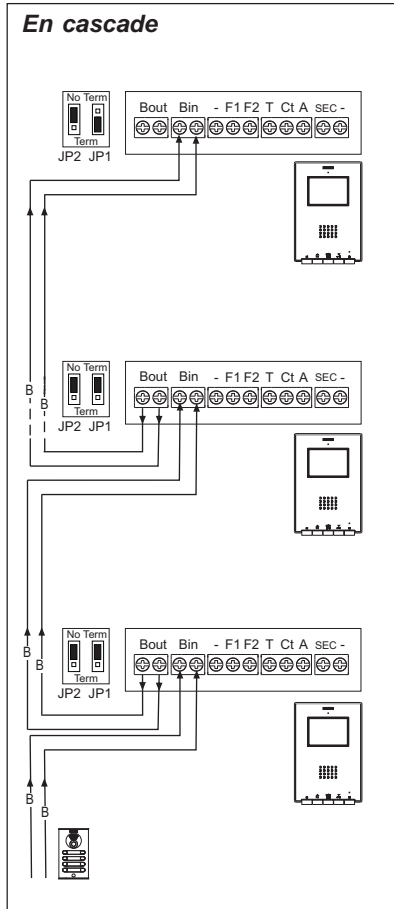

En distribution

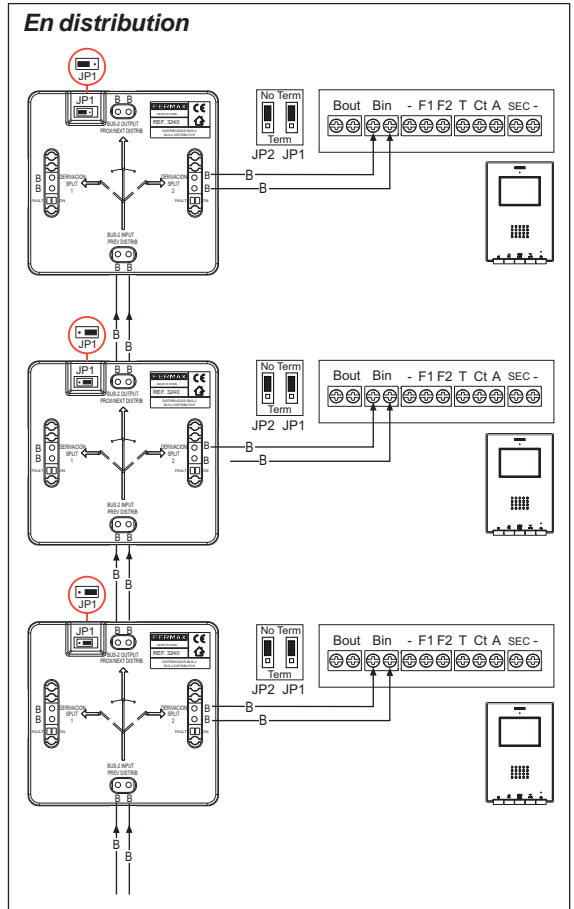

Moniteur supplémentaire

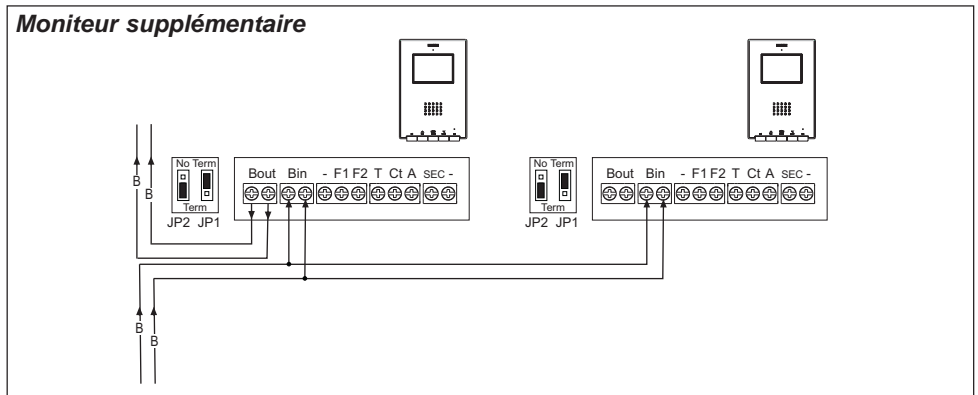

Remarque : configurez les commutateurs JP1 et JP2 comme expliqué sur la page précédente.

PROGRAMMATION DU MONITEUR iLOFT

1°. Entrer en mode programmation

Option 1

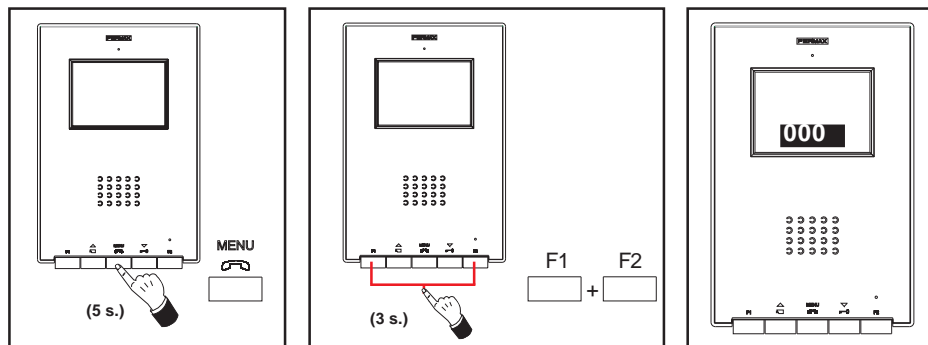

Si le moniteur est connecté :

- Appuyez sur le bouton « MENU » pendant 5 secondes. La mélodie programmée pour la platine principale est émise.
- Appuyez sur les boutons « F1 » et « F2 » simultanément pendant 3 secondes. Un bip de confirmation est émis. L'écran du moniteur s'active et l'adresse du moniteur s'affiche dans un encadré.

La DEL bleue reste fixe.

Option 2

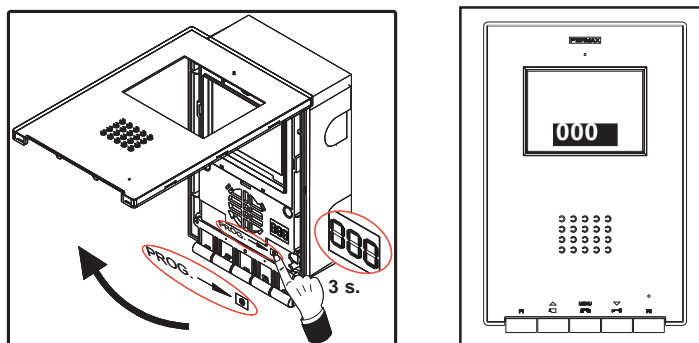

Si le moniteur est connecté :

- Appuyez sur le bouton « PROG » pendant 1 seconde. L'écran du moniteur s'active et l'adresse du moniteur s'affiche dans un encadré.

La DEL bleue reste fixe.

2°. Programmer l'adresse du moniteur

Option 1 : depuis la platine de rue

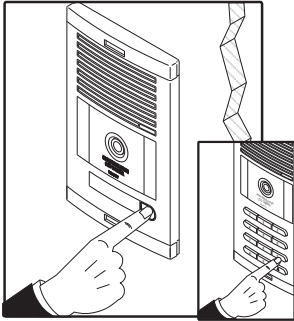

Appuyez sur le bouton d'appel à destination du logement (platines à boutons-poussoirs) ou composez le code d'appel (platines à clavier). La confirmation se fait via une tonalité d'appel et le numéro programmé s'affiche à l'écran.

Option 2 : à partir du moniteur

2.1- Appuyez sur le bouton correspondant aux centaines, dizaines ou unités pour augmenter le chiffre correspondant (s'affiche à l'écran) :

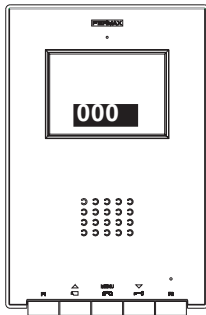

Centaines :

appuyez sur le bouton 

Dizaines :

appuyez sur le bouton 

Unités :

appuyez sur le bouton 

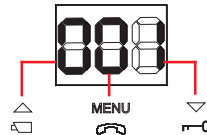

Une fois arrivé au 9 et si vous appuyez une fois de plus, vous parviendrez au 0 et une tonalité d'erreur (son grave) sera émise. En appuyant une fois de plus, la numérotation reprend au numéro 1.

2.2- Confirmer l'adresse : appuyez sur les boutons « F1 » et « F2 » simultanément pendant 3 secondes jusqu'à ce qu'un bip de confirmation soit émis.

Si 90 secondes s'écoulent sans que l'adresse sélectionnée soit confirmée, le moniteur conserve l'adresse programmée avant l'entrée en mode programmation.

PROGRAMMATION DU MONITEUR iLOFT en tant que moniteur SECONDAIRE

1°. Entrer en mode programmation

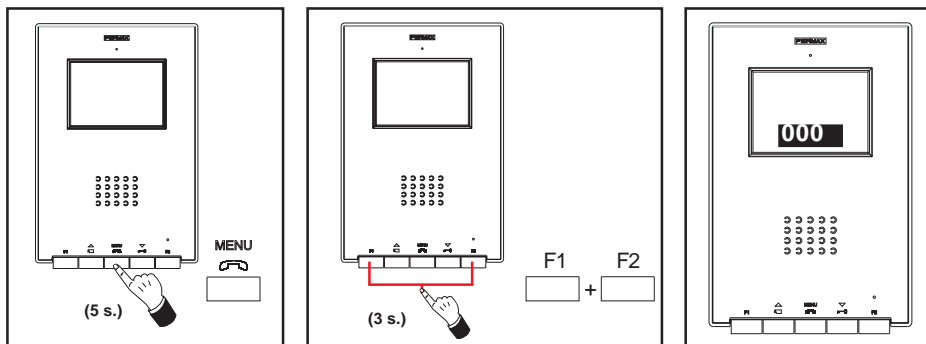

Si le moniteur est connecté :

- Appuyez sur le bouton « MENU » pendant 5 secondes. La mélodie programmée pour la platine principale est émise.
- Appuyez sur les boutons « F1 » et « F2 » simultanément pendant 3 secondes. Un bip de confirmation est émis. L'écran du moniteur s'active et l'adresse du moniteur s'affiche dans un encadré.

La DEL bleue reste fixe.

2°. Programmer l'adresse du moniteur à partir du moniteur

2.1- Appuyez sur le bouton correspondant aux centaines, dizaines ou unités pour augmenter le chiffre correspondant (s'affiche à l'écran) :

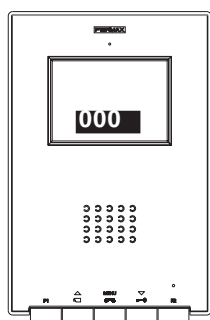

Centaines :

appuyez sur le bouton 

Dizaines :

appuyez sur le bouton 

Unités :

appuyez sur le bouton 

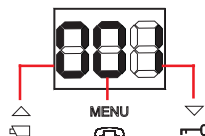

Une fois arrivé au 9 et si vous appuyez une fois de plus, vous parviendrez au 0 et une tonalité d'erreur (son grave) sera émise. En appuyant une fois de plus, la numérotation reprend au numéro 1.

2.2- Appuyez sur la touche « F2 » jusqu'à ce qu'une tonalité de confirmation soit émise.

2.3- Confirmer l'adresse : appuyez sur les boutons « F1 » et « F2 » simultanément pendant 3 secondes jusqu'à ce qu'un bip de confirmation soit émis.

Si 90 secondes s'écoulent sans que l'adresse sélectionnée soit confirmée, le moniteur conserve l'adresse programmée avant l'entrée en mode programmation.

FONCTIONNEMENT MONITEUR iLOFT

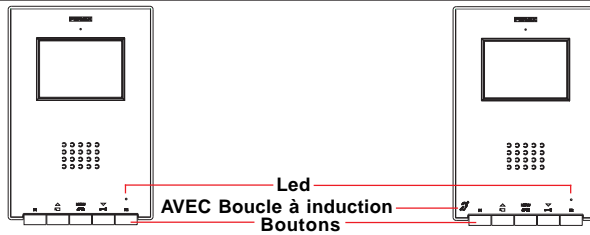

AVEC boucle à induction. Sont identifiés à l'aide de ce symbole.

- Comprend une boucle à induction qui interagit avec les appareils auditifs des personnes malentendantes.
- **Remarque :** pour les appareils auditifs avec sélection manuelle du mode, il faut configurer le mode numérique.

Boutons



Bouton pour l'activation du son, pour raccrocher et pour les réglages de la configuration (menu).

- Si vous recevez un appel, appuyez sur ce bouton pour parler avec le visiteur. Le canal audio sens rue-logement s'active et le tout fonctionne en mode mains libres.
- Cliquez pour couper la communication.
- Si le moniteur est en veille, appuyez sur le bouton pendant 5 secondes pour entrer en mode configuration du moniteur. Voir rubrique « Réglages du moniteur ».



Bouton-poussoir de la gâche électrique / appel au concierge.

- Lors d'une communication avec la platine de rue, la *gâche électrique* est activée en appuyant sur ce bouton.
- Lorsque le moniteur est en veille, en appuyant sur ce bouton, un *appel à destination du concierge* est effectué (s'il y a une conciergerie).



Bouton d'allumage automatique / sélection caméra principale-secondaire.

- Si le moniteur est en veille, appuyez sur la touche pendant 1 seconde pour allumer manuellement le moniteur. Afin d'activer le son, appuyez sur la touche .
- Lorsqu'il y a de l'image, pour sélectionner la caméra principale ou la caméra secondaire (s'il y en a une) l'une à la suite de l'autre, appuyez sur la touche et maintenez-la enfoncée pendant 2 secondes.

F1 F1 et F2 : boutons pour fonctions supplémentaires (assignées par l'installateur).

DEL

	Statut DEL	Statut moniteur
Rouge	1 clignotement toutes les secondes	En mode programmation
	1 clignotement toutes les 2 secondes	Annulation tonalité d'appel activée
Verte	Allumée couleur verte	Mode « Ouverture automatique » activé
Verte et rouge	Allumée, passe du vert au rouge	Annulation tonalité d'appel et mode « Ouverture automatique » activés
Bleue	Allumée couleur bleue	Communication établie/Canal occupé/réglages

Fonctionnement

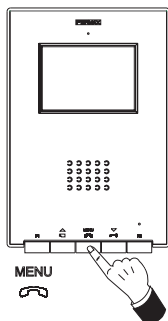

Prendre un appel

En appuyant sur le bouton-poussoir d'appel sur la **platine de rue**, il se produit une tonalité d'appel aussi bien au niveau de la platine de rue que du moniteur ; l'écran s'allume.

Appuyez sur la touche **MENU** afin de pouvoir parler avec le visiteur. Le canal audio sens rue-logement s'active et le **tout fonctionne en mode mains libres**. La communication est automatiquement coupée au bout de 90 secondes ou auparavant en appuyant sur le bouton **MENU**.

La DEL restera allumée (en bleu) pendant la durée de la conversation.

Si aucune communication n'est établie avec la platine de rue, le moniteur s'éteindra automatiquement au bout de 30 s.

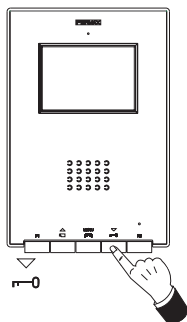

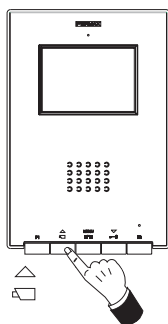

Ouverture de la porte

Si vous recevez un appel depuis la platine de rue, il est possible d'ouvrir la porte à tout moment en appuyant sur le bouton .



Activation manuelle du moniteur (allumage automatique)

Si le moniteur est en veille, appuyez sur cette touche  pendant 1 seconde pour allumer manuellement le moniteur. Pour sélectionner la caméra principale ou la caméra secondaire (s'il y en a une) l'une à la suite de l'autre, appuyez sur la touche  et maintenez-la enfoncée pendant 2 secondes.

Pour activer le son, parler avec le visiteur ou ouvrir la porte, effectuez les étapes décrites antérieurement.

Si aucune communication n'est établie avec la platine de rue, le moniteur s'éteindra automatiquement au bout de 30 s.

REMARQUES :

L'écran du moniteur s'allume une fois l'appel en provenance de la platine terminé.

S'il existe plus d'un moniteur iLoft sur l'installation et qu'on effectue un appel à destination du moniteur, les autres moniteurs présentent la DEL en bleu indiquant de la sorte que le canal est occupé.

Fonctionnement

Annuler tonalité d'appel

Lorsque le moniteur est en veille, appuyez 3 fois de suite sur le bouton  en moins de 2 secondes à peu près.

La DEL rouge clignote 1 fois toutes les 2 secondes.

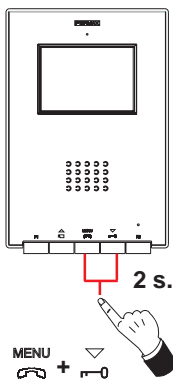
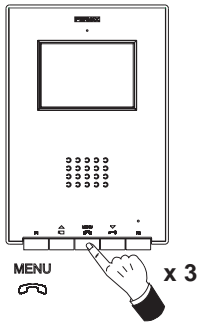

Pour désactiver l'annulation de la tonalité d'appel, appuyez de nouveau 3 fois de suite sur le bouton  en moins de 2 secondes.

La DEL revient à son état précédent.





Mode « Ouverture automatique »

Lorsque le mode « Ouverture automatique » est activé, le moniteur active automatiquement la gâche électrique 5 secondes après avoir reçu un appel en provenance de la platine.

Pour activer le mode « Ouverture automatique », appuyez simultanément pendant 2 secondes sur les boutons  + .

La DEL reste en vert.

Pour désactiver le mode « Ouverture automatique », appuyez simultanément pendant 2 secondes sur les boutons  + .

La DEL revient à son état précédent.

Remarque : si « l'annulation de la tonalité d'appel » et « l'ouverture automatique » sont activées en même temps, la DEL du moniteur passe du rouge au vert toutes les secondes.

Réglage volume son

Tout en étant en communication avec la platine de rue, maintenez le bouton  enfoncé jusqu'à ce que le menu suivant apparaisse à l'écran :

sn 3 - Appuyez sur le bouton  pour augmenter le *niveau sonore*.

- Appuyez sur le bouton  pour réduire le *niveau sonore*.

(il existe 5 niveaux de son pouvant être sélectionnés : sn1...sn5)

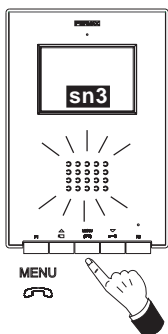

Il est possible d'établir une communication avec la platine de rue sans avoir à recevoir un appel en provenance de cette dernière, en effectuant un « **allumage automatique** » (appuyer sur  et en appuyant ensuite sur le bouton .

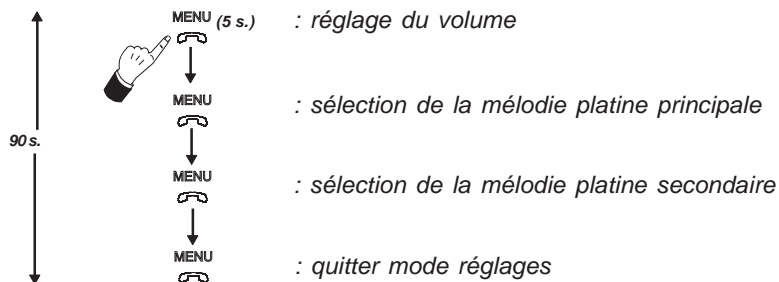

RÉGLAGES MONITEUR iLOFT

Réglages du volume et sélection des mélodies



- **Accès au mode « réglage du volume »** : appuyez sur le bouton «  » pendant 5 secondes (la DEL clignote 1 fois par seconde et la tonalité d'appel de la platine principale est émise).

Le moniteur iLoft dispose de 5 niveaux de volume différents :



- Appuyez sur le bouton  pour augmenter le volume.
- Appuyez sur le bouton  pour réduire le volume.

Une fois le niveau le plus faible ou le plus élevé atteint, un double bip est émis indiquant que l'on est arrivé au niveau minimal ou maximal.

- **Accès au mode « sélection de la mélodie »**



Mélodie pour appel en provenance de la platine principale :

En mode « réglage du volume », appuyez sur le bouton «  » jusqu'à entendre de nouveau la tonalité d'appel de la platine principale.

- Appuyez sur la touche  pour sélectionner la mélodie suivante.
- Appuyez sur la touche  pour sélectionner la mélodie précédente.

Mélodie pour appel en provenance de la platine secondaire :

En mode « sélection de la mélodie pour platine principale », appuyez sur le bouton «  » jusqu'à entendre de nouveau la tonalité d'appel de la platine principale.

- Appuyez sur la touche  pour sélectionner la mélodie suivante.
- Appuyez sur la touche  pour sélectionner la mélodie précédente.

- **Quitter le mode « réglage du volume et sélection de la mélodie »**

En mode « sélection de la mélodie pour platine secondaire », appuyez sur le bouton «  » jusqu'à ce qu'un long bip de confirmation soit émis.

Réglages de l'image (contraste, luminosité, couleur)

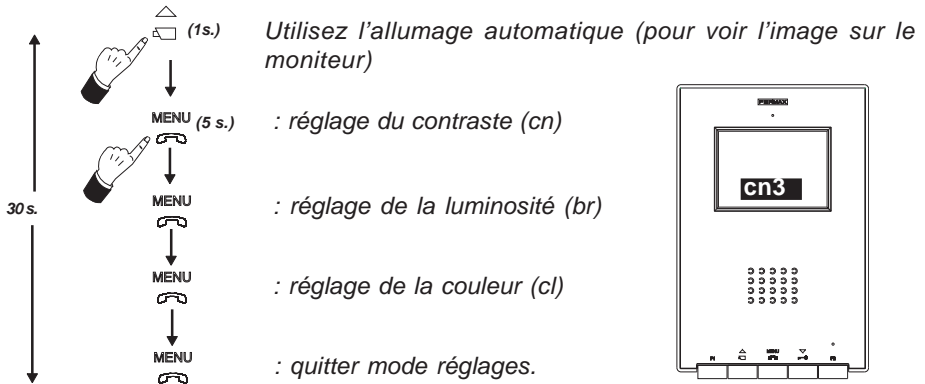

Le moniteur ILOFT dispose de 5 niveaux prédéfinis pour le réglage du contraste, de la luminosité et de la couleur.

- Accès au mode « réglage du contraste » :

1- Utilisez l'allumage automatique : appuyez sur le bouton  jusqu'à ce que l'image apparaisse à l'écran.

2- Appuyez sur le bouton «  » pendant 5 secondes.

Un bip de confirmation est émis et le menu de réglage du contraste s'affiche.

cn3

- Appuyez sur le bouton  pour augmenter le *niveau du contraste*.

- Appuyez sur le bouton  pour réduire le *niveau du contraste*.

- Accès au mode « réglage de la luminosité » :

En mode « réglage du contraste », appuyez sur le bouton «  » :

br5

- Appuyez sur le bouton  pour augmenter le *niveau de la luminosité*.

- Appuyez sur le bouton  pour réduire le *niveau de la luminosité*.

- Accès au mode « réglage de la couleur » :

En mode « réglage de la luminosité », appuyez sur le bouton «  » :

cl5

- Appuyez sur le bouton  pour augmenter le *niveau de la couleur*.

- Appuyez sur le bouton  pour réduire le *niveau de la couleur*.

- **Quitter le mode « réglage de l'image »** : en mode « réglages de la couleur », appuyez sur le bouton «  ».

Remarque : le moniteur s'éteint si les 30 secondes de programmation se sont déjà écoulées. Les dernières valeurs présentées à l'écran sont alors enregistrées pour chaque réglage.

MONITORINSTALLATION UNTERPUTZKASTEN

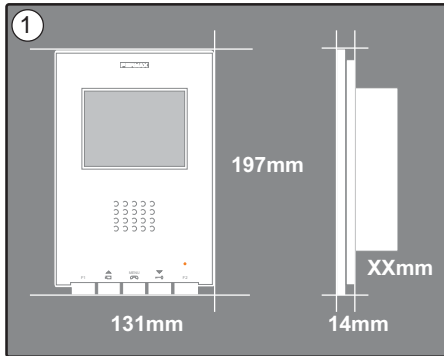

Abmessungen Monitor (Höhe x Breite x Tiefe*):

197 x 131 x 60 mm / 7,7" x 5,1" x 2,3"

Abmessungen Pure Monitor (Höhe x Breite x Tiefe*):

197 x 131 x 59 mm / 7,7" x 5,1" x 2,3"

Abmessungen des Fermax-Kastens (Höhe x Breite x Tiefe):

158 x 108 x 45 mm / 6.2" x 4.2" x 1.7"

Abmessungen Universalkasten (Höhe x Breite x Tiefe):

174 x 114 x 50 mm / 6.8" x 4.5" x 2"

Hinweise:

- Dieser Monitor kann in einem Universalkasten installiert werden.
- **Tiefe***: Die Tiefe des Monitors ist auf den Fermax-Kasten abgestimmt.

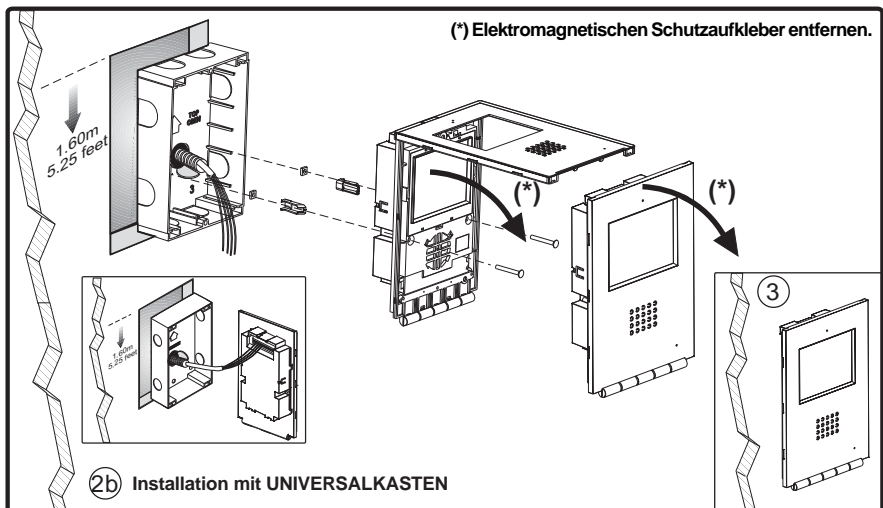
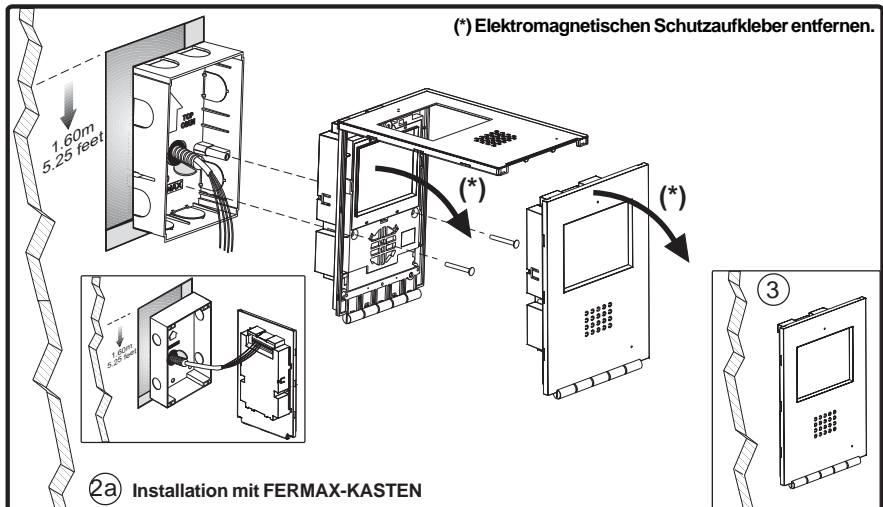

MONITORINSTALLATION AUFPUTZKASTEN

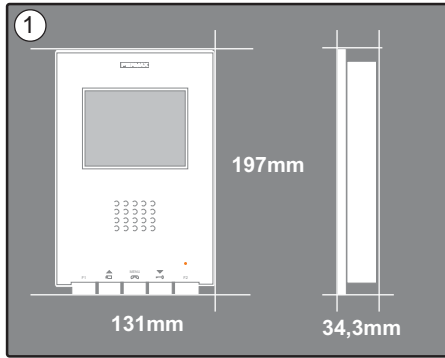

Abmessungen des Monitors (Höhe x Breite x Tiefe):
197 x 131 x 34,3 mm / 7,7" x 5,1" x 1,3"

Abmessungen des Pure Monitors (Höhe x Breite x Tiefe):
197 x 131 x 33,3 mm / 7,7" x 5,1" x 1,3"

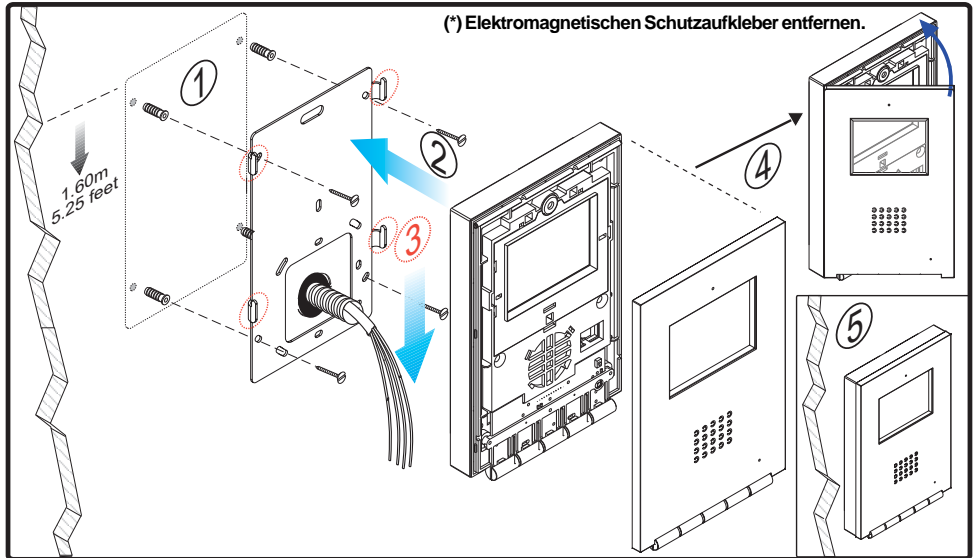

ANSCHLÜSSE

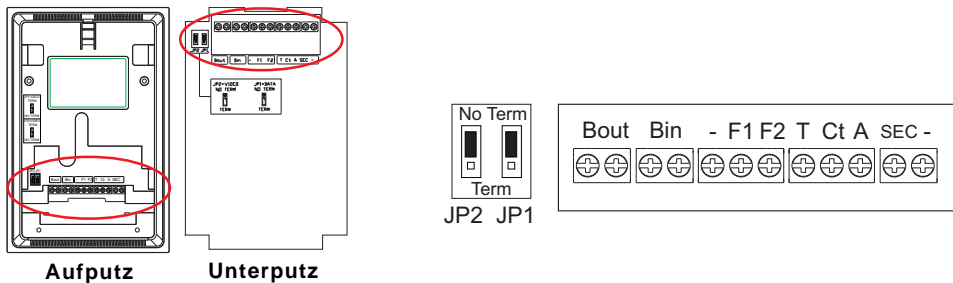

Bin	- Audio und Video-Kommunikationsbus (ohne Polarität) - Zusätzlicher Monitor- und Telefonanschluss
Bout	Anschluss an den nachfolgenden Monitor/Telefon bei Kaskadenanordnung
F1, F2	Zusatzfunktionen (Negativausgang "-"). Maximalstrom durch Taste F1,F2: 150 mA
T,-	Anschluss Ruftaste Wohnungstür
CT	Falls das Videosignal beim Monitor aktiviert wird, wird an der Klemme eine Spannung von 10 VDC generiert (Aktivierung Hilfskamera).
A, -	Anschluss Anrufererweiterungsmodul, Ref. 2040.
SEC	Wenn ein Anruf am Monitor eingeht, wird fünf Sekunden lang eine Spannung von 12 VDC erzeugt.

JP1	Bei <i>Anlagen mit Kaskadenanordnung</i> : - Stecken Sie die Steckbrücke JP1 bei den Monitoren im ersten Stockwerk und den Zwischenstockwerken auf NO TERM um. - Stecken Sie die Steckbrücke JP1 beim letzten Monitor (letztes Stockwerk) auf TERM um. Bei <i>Anlagen mit Verzweigungen</i> stecken Sie die Steckbrücke JP1 bei allen Monitoren auf NO TERM um.
JP2	- Falls nur ein Monitor pro Wohnung vorhanden ist, stecken Sie die Steckbrücke JP2 auf „NO TERM“ um. - Falls zwei Monitore vorhanden sind (bzw. ein Monitor und ein Telefon), muss die Steckbrücke JP2 an beiden Geräten auf „TERM“ umgesteckt werden.

TECHNISCHE EIGENSCHAFTEN

	Stromversorgung	24 Vdc	
	Stromverbrauch	OHNE induktiver Schleife	MIT induktiver Schleife ⚡
	im Bereitschaftsmodus	36 mA	34 mA
	bei Anruf	350 mA	490 mA
	bei Videoübertragung	250 mA	330 mA
	bei Audio- und Videoübertragung	390 mA	bei max. Lautstärke 634 mA
Betriebstemperatur		[5, +40 °C] [41, +104 °F]	
Relative Luftfeuchtigkeit		[0 - 90%]	
TFT Flachbildschirm Diagonale 3,5"			
Auflösung: Horizontal: 480 Bildpunkte - Vertikal: 234 Bildpunkte			
Videosignal: Moduliertes Signal 4,5 Vpp			
Abmessungen des Einbaumonitors (Höhe x Breite x Tiefe): 197 x 131 x 60 mm / 7,7" x 5,1" x 2,3"			
Abmessungen des Einbaumonitors Pure (Höhe x Breite x Tiefe): 197 x 131 x 59 mm / 7,7" x 5,1" x 2,3"			
Abmessungen des Monitors zur Oberflächenmontage(Höhe x Breite x Tiefe): 197 x 131 x 34,3 mm / 7,7" x 5,1" x 1,3"			
Abmessungen des Monitors zur Oberflächenmontage Pure (Höhe x Breite x Tiefe): 197 x 131 x 33,3 mm / 7,7" x 5,1" x 1,3"			

SCHEMATA

Kaskadenanordnung

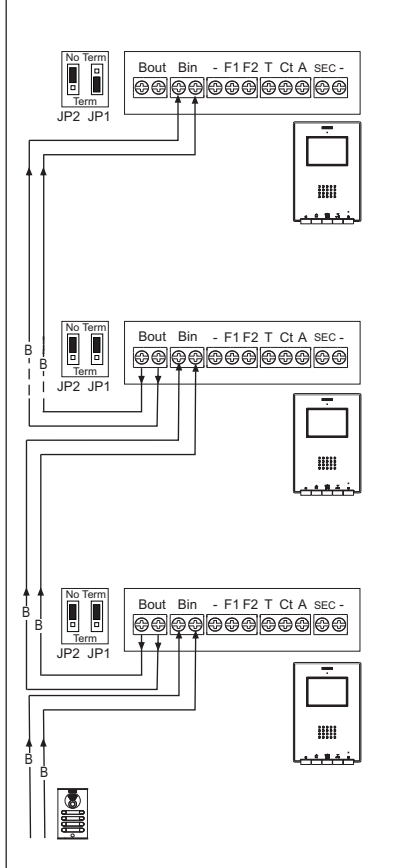

mit Verzweigungen

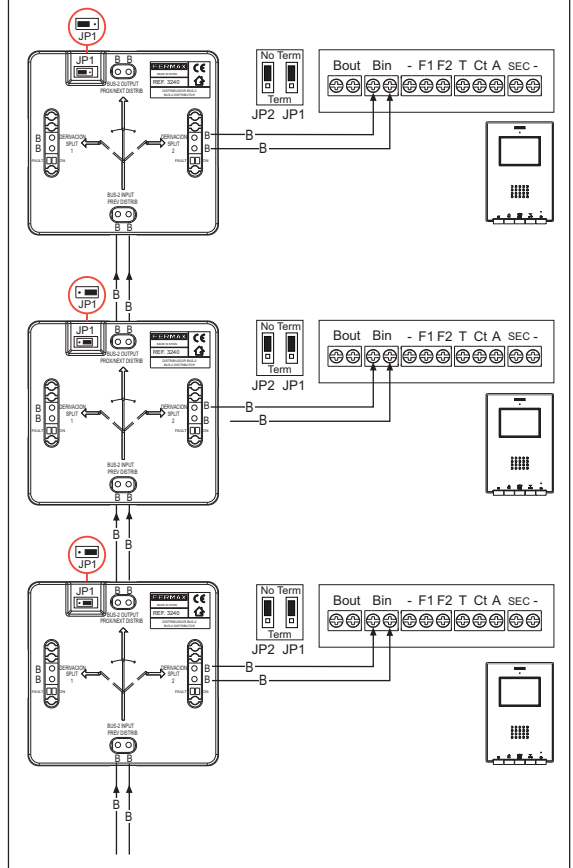

Zusatzmonitor

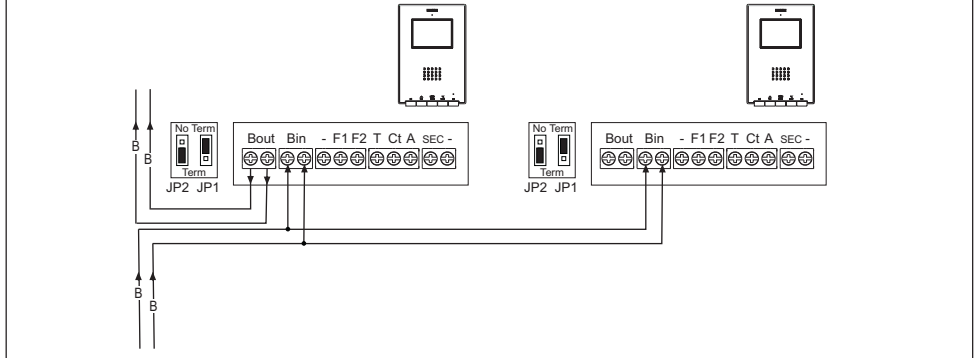

Hinweis: Konfiguration der Steckbrücken JP1 und JP2, so wie auf der vorherigen Seite erläutert.

iLOFT MONITORPROGRAMMIERUNG

1. Zugang in den Programmiermodus

Option 1

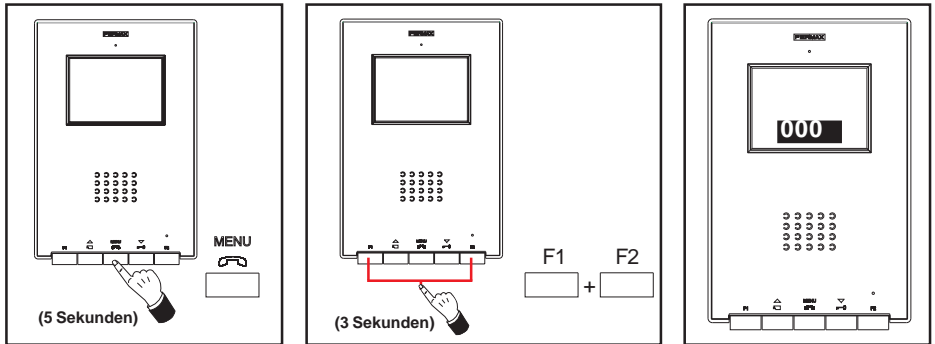

Bei eingeschaltetem Monitor:

- Den Schalter "MENU" 5 Sekunden lang drücken. Nun ertönt die einprogrammierte Melodie der Haupttürstation.
- Drücken Sie drei Sekunden lang die Tasten "F1" und "F2". Es ertönt ein Signalton und der Monitor aktiviert sich und zeigt auf dem Feld die aktuelle Adresse des Monitors an.

Die durchgehend blau leuchtende LED.

Option 2

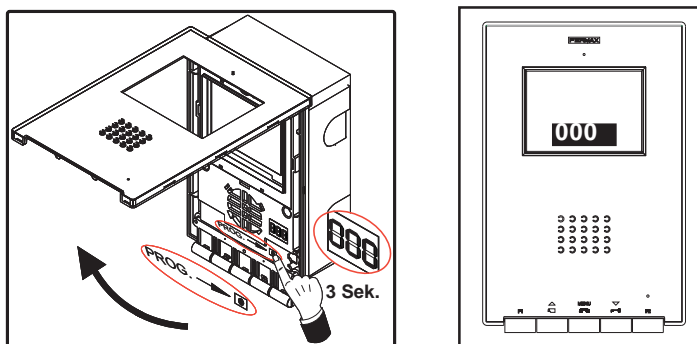

Bei eingeschaltetem Monitor:

- Die Taste "PROG" drei Sekunden lang gedrückt halten. Der Bildschirm des Monitors aktiviert sich und auf dem Anzeigefeld erscheint die aktuelle Monitoradresse.

Die durchgehend blau leuchtende LED.

2. Programmierung der Monitoradresse.

Option 1: Über die Türstation

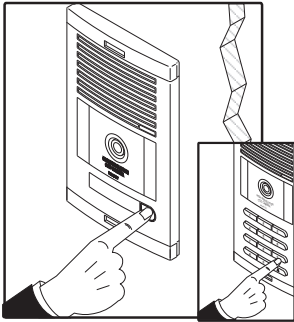

Drücken Sie die Ruftaste der Wohnung (Türstation mit Infomodul) oder geben Sie den Rufcode ein (Türstationen mit Tastatur). Es ertönt ein Rufton und auf dem Bildschirm wird die einprogrammierte Nummer angezeigt.

Option 2: Über den Monitor

2.1- Drücken Sie die entsprechenden Tasten der Hunderter-, Zehner- und Einereinheit, um die die Zahl um jeweils eine Einheit zu erhöhen (Anzeige auf dem Bildschirm):

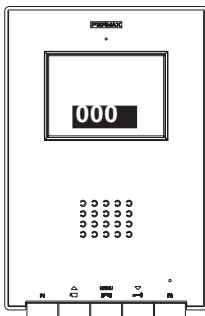

Hundertereinheit:

Drücken Sie die Taste 

Zehnerereinheit:

Drücken Sie die Taste 

Einereinheit:

Drücken Sie die Taste 

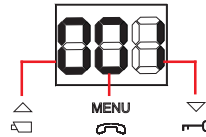

Beim Erreichen von 9 und erneutem Drücken erscheint die Ziffer 0 und es ertönt ein tiefer Fehlerton. Bei erneutem Drücken beginnt die Anzeige wieder bei 1.

2.2- Bestätigung der Adresse: Drücken Sie drei Sekunden lang die Tasten "F1" und "F2" bis der Vorgang durch einen Signalton bestätigt wird.

Falls 90 Sekunden verstreichen, ohne dass die eingegebene Adresse bestätigt wird, behält der Monitor vor dem Zugang in den Programmiermodus einprogrammierte Adresse bei.

iLOFT MONITORPROGRAMMIERUNG als ZUSATZMONITOR

1. Zugang in den Programmiermodus

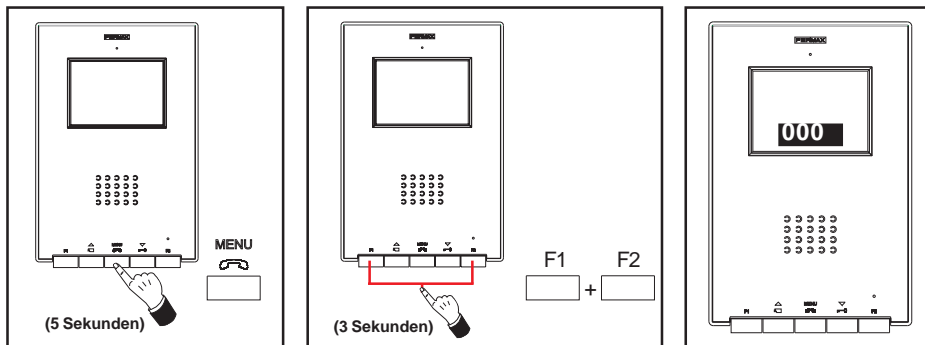

Bei eingeschaltetem Monitor:

- Den Schalter "MENU" 5 Sekunden lang drücken. Nun ertönt die einprogrammierte Melodie der Haupttürstation.
- Drücken Sie drei Sekunden lang die Tasten "F1" und "F2". Es ertönt ein Signalton und der Monitor aktiviert sich und zeigt auf dem Feld die aktuelle Adresse des Monitors an.

Die durchgehend blau leuchtende LED.

2. Programmierung der Monitoradresse Über den Monitor.

2.1- Drücken Sie die entsprechenden Tasten der Hunderter-, Zehner- und Einereinheit, um die die Zahl um jeweils eine Einheit zu erhöhen (Anzeige auf dem Bildschirm):

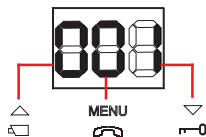
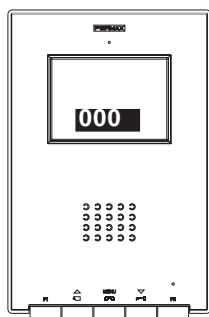

Hundertereinheit:

Drücken Sie die Taste

Zehnerereinheit:

Drücken Sie die Taste

Einereinheit:

Drücken Sie die Taste

Beim Erreichen von 9 und erneutem Drücken erscheint die Ziffer 0 und es ertönt ein tiefer Fehlerton. Bei erneutem Drücken beginnt die Anzeige wieder bei 1.

2.2- Taste «F2»edrückt halten, bis ein Signalton zur Bestätigung ertönt.

2.3- Bestätigung der Adresse: Drücken Sie drei Sekunden lang die Tasten "F1" und "F2" bis der Vorgang durch einen Signalton bestätigt wird.

Falls 90 Sekunden verstreichen, ohne dass die eingegebene Adresse bestätigt wird, behält der Monitor vor dem Zugang in den Programmiermodus einprogrammierte Adresse bei.

FUNKTIONSWEISE MONITOR iLOFT

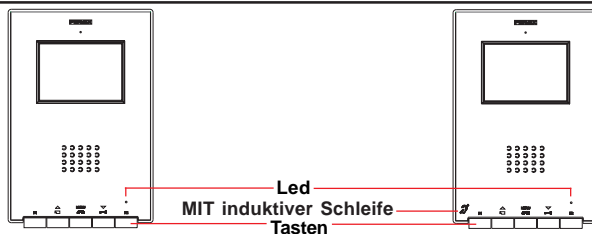

MIT induktiver Schleife. Sie werden mit diesem Symbol gekennzeichnet.

- Enthält eine induktive Schleife, die sicherstellt, dass Personen mit eingeschränktem Hörvermögen die Mitteilungen hören können.
- **Hinweis:** Bei Hörgeräten, bei denen der Betriebsmodus manuell einzustellen ist, muss dieser auf Digitaler Modus geschaltet werden.

Tasten



Taste Audioaktivierung, Aufhängen und Einstellungen (Menü)

- Drücken Sie bei einem eingehenden Anruf auf diese Taste, um mit dem Besucher zu sprechen. Der Audiokanal wird in Richtung Türstation und Wohnung freigegeben und auf Freisprechbetrieb geschaltet.
- Taste drücken, um die Verbindung zu beenden.
- Drücken Sie diese Taste 5 Sekunden lang, wenn sich der Monitor im Bereitschaftsmodus befindet, um in den Konfigurationsmodus des Monitor zu gelangen. Siehe Abschnitt "Monitor-Einstellungen"



Türöffnungstaste / Portierruf

- Bei bestehender Sprechverbindung zur Türstation wird durch Drücken dieser Taste der *Türöffner* aktiviert.
- Durch Drücken dieser Taste wird eine *Verbindung zur Portierzentrale* hergestellt (falls vorhanden), wenn sich der Monitor im Bereitschaftsmodus befindet.



Eigenstarttaste / Kamerawahlstaste

- Drücken Sie diese Taste eine Sekunde lang, wenn sich der Monitor im Bereitschaftsmodus befindet, um ihn manuell einzuschalten. Um die Audiofunktion zu aktivieren, drücken Sie die Taste .
- Um zwischen der Haupt- und der Zusatzkamera (falls vorhanden) hin- und herzuschalten, halten Sie diese Taste zwei Sekunden lang gedrückt.

F1

F1 und F2: Tasten für Zusatzfunktionen (Festgelegt durch den Installateur)

LED

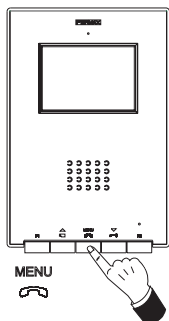

	LED-Zustandsanzeige	Monitorzustand
Rot	<i>Blinkt im Sekundenintervall</i>	Im Programmiermodus
	<i>Blinkt im 2-Sekundenintervall</i>	Unterbrechung Rufton aktiviert
Grün	<i>Eingeschaltet Farbe grün</i>	Modus "Automatische Türöffnung" aktiviert
Grün Rot	<i>Eingeschaltet, wechselndes Aufleuchten in grün und rot</i>	Unterbrechung Rufton und Modus "Automatische Türöffnung" aktiviert
Blau	<i>Eingeschaltet Farbe blau.</i>	Verbindung hergestellt/Sprechkanal besetzt/Einstellungen.

Betrieb



Anrufannahme

Beim Drücken der Ruftaste an der **Türstation** wird ein Rufton an der Türstation und am Monitor ausgegeben und der Bildschirm schaltet sich ein.

Drücken Sie die Taste , um mit dem Besucher zu sprechen. Der Audiokanal wird in beide Richtungen aktiviert und auf **Freisprechbetrieb geschaltet**. Die Sprechverbindung wird nach 90 Sekunden automatisch oder durch Drücken der Taste  unterbrochen.

Die LED (blau) leuchtet während der Dauer des Sprechbetriebs.

Falls keine Sprechverbindung mit der Türstation hergestellt wird, schaltet sich der Monitor nach Ablauf von 30 Sekunden automatisch aus.

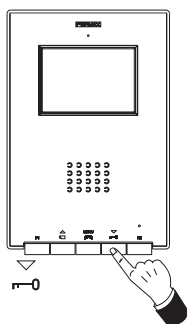

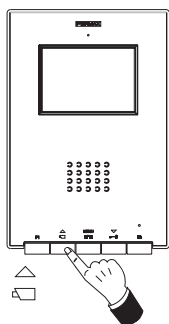

Türöffnung

Bei einem eingehenden Anruf von der Türstation kann die Tür zu jeder Zeit durch Drücken der Taste  geöffnet werden.



Manuelle Aktivierung des Monitors (Eigenstart)

Drücken Sie die Taste  des Monitors im Bereitschaftsmodus eine Sekunde lang, um den Monitor manuell einzuschalten. Halten Sie die Taste  zwei Sekunden lang gedrückt, um zwischen der Haupt- und Nebenkamera hin- und herzuschalten.

Zur Aktivierung der Audioverbindung und Herstellung des Sprechbetriebs oder zur Türöffnung müssen Sie vorgehen wie zuvor geschildert.

Falls keine Sprechverbindung mit der Türstation hergestellt wird, schaltet sich der Monitor nach Ablauf von 30 Sekunden automatisch aus.

HINWEISE:

Der Monitorbildschirm schaltet sich ein, nachdem der Anruf von der Türstation beendet ist. Falls mehrere Monitore iLoft in der Anlage installiert wurden und ein Anruf an einen Monitor erfolgt, leuchtet bei allen weiteren Monitoren die LED blau und zeigt an, dass der Sprechkanal besetzt ist.

Betrieb

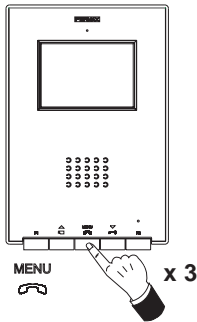

Unterbrechung des Ruftons

Drücken Sie innerhalb von zwei Sekunden drei Mal die Taste , wenn sich der Monitor im Bereitschaftsmodus befindet.

Die rote LED blinkt im 2-Sekundenintervall auf.

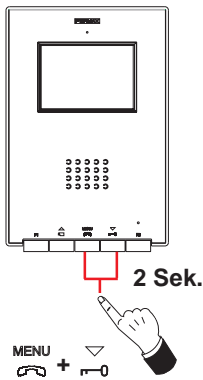

Zur Deaktivierung der Rufonunterbrechung müssen Sie innerhalb von zwei Sekunden die Taste  drei Mal drücken.

Die LED-Zustandsanzeige ändert sich.





Modus "Automatische Türöffnung"

Bei aktiviertem Modus "Automatische Türöffnung" löst der Monitor bei eingehendem Anruf und nach Ablauf von fünf Sekunden automatisch den Türöffner aus.

Zur Aktivierung des Modus "Automatische Türöffnung" drücken Sie gleichzeitig zwei Sekunden lang die Tasten  + .

Die LED leuchtet dabei grün auf.

Zur Deaktivierung des Modus "Automatische Türöffnung" drücken Sie gleichzeitig zwei Sekunden lang die Tasten  + .

Die LED-Zustandsanzeige ändert sich.

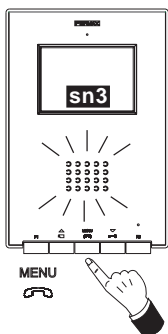

Hinweis: Falls gleichzeitig "Unterbrechung Rufton" und "Automatische Türöffnung" aktiviert sind, wechselt die LED-Anzeige im Sekundentakt zwischen grün und rot.





Einstellung der Lautstärke

Drücken Sie die Taste  bei hergestellter Sprechverbindung mit der Türstation, bis auf dem Bildschirm folgendes Menü erscheint:

sn 3

- Drücken Sie die Taste , um die *Lautstärke* zu erhöhen.
- Drücken Sie die Taste , um die *Lautstärke* zu verringern.

(Es stehen fünf Lautstärkestufen zur Verfügung: sn1 ... sn5)

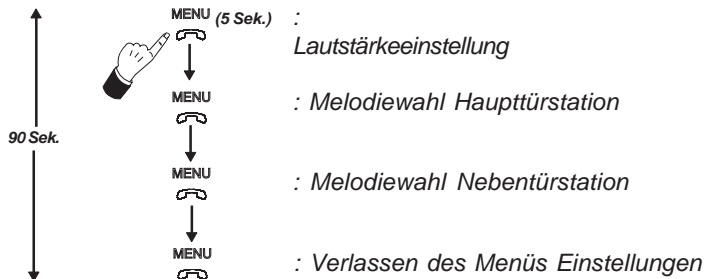

Es ist möglich eine Sprechverbindung mit der Türstation herzustellen, ohne dass dazu ein Anruf von der Türstation zu erfolgen hat, dazu drückt man auf , "**Eigenstart**" und anschließend auf die Taste .

EINSTELLUNGEN MONITOR iLOFT

Einstellung der Lautstärke und Melodiewahl

- **Zugang in den "Lautstärkemode"**: Drücken Sie 5 Sekunden lang die Taste "MENU" (Die LED blinkt im Sekundenintervall auf und an der Haupttürstation wird ein Rufton ausgegeben).



Der Monitor iLoft verfügt über fünf Lautstärkestufen:

- Drücken Sie die Taste , um die Lautstärke zu erhöhen.
- Drücken Sie die Taste , um die Lautstärke verringern.

Wenn die maximale bzw. minimale Lautstärkestufe erreicht wird, ertönt ein zweifacher Signalton und zeigt an, dass die maximale bzw. minimale Stufe erreicht ist.



- **Zugang in den "Melodiewahlmodus"****Melodie für einen von der Haupttürstation eingehenden Anruf:**

Drücken Sie im "Lautstärkemode" die Taste "MENU", bis der Rufton der Haupttürstation erneut ertönt.

- Drücken Sie die Taste , um die nachfolgende Melodie auszuwählen.
- Drücken Sie die Taste , um die vorherige Melodie auszuwählen.

Melodie für einen von der Nebentürstation eingehenden Anruf:

Drücken Sie im Modus "Melodiewahl Haupttürstation" die Taste "MENU", bis der Rufton der Haupttürstation erneut ertönt.

- Drücken Sie die Taste , um die nachfolgende Melodie auszuwählen.
- Drücken Sie die Taste , um die vorherige Melodie auszuwählen.

- **Verlassen des "Lautstärke- und Melodiewahlmodus"**

Drücken Sie im Modus "Melodiewahl Nebentürstation" die Taste "MENU", bis ein langer Signalton zur Bestätigung ausgegeben wird.

Bildeinstellungen (Kontrast, Helligkeit, Farbe)

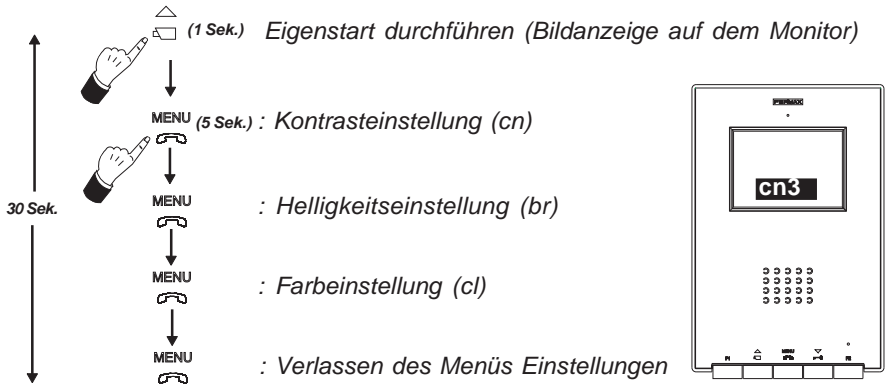

Der Monitor iLOFT verfügt über 5 Einstellstufen für Kontrast, Helligkeit und Farbe.

- Zugang in den Modus "Kontrasteinstellung":

1. - Eigenstart durchführen: Drücken Sie die Taste , bis auf dem Monitor ein Bild erscheint.

2.- Drücken Sie 5 Sekunden lang die Taste "MENU" .

Es ertönt ein Signalton und auf dem Bildschirm wird das Menü Kontrasteinstellung eingeblendet.



- Drücken Sie die Taste , um den *Kontrast* zu erhöhen.

- Drücken Sie die Taste , um den *Kontrast* zu verringern.

- Zugang in den Modus "Helligkeitseinstellung":

Drücken Sie im Modus "Kontrasteinstellung" die Taste "MENU" .



- Drücken Sie die Taste , um die *Helligkeit* zu erhöhen.

- Drücken Sie die Taste , um die *Helligkeit* zu verringern.

- Zugang in den Modus "Farbeinstellung":

Drücken Sie im Modus "Farbeinstellung" die Taste "MENU" .



- Drücken Sie die Taste , um die *Farbintensität* zu erhöhen.

- Drücken Sie die Taste , um die *Farbintensität* zu verringern.

- Verlassen des Menüs "Bildeinstellungen": Drücken Sie im Modus "Farbeinstellung" die Taste "MENU" .

Hinweis: Falls sich der Monitor nach Ablauf von 30 Sekunden im Programmiermodus automatisch ausschaltet, werden die zuletzt auf dem Bildschirm angezeigten Werte gespeichert.

INSTALAÇÃO DE MONITOR DE ENCASTRAR

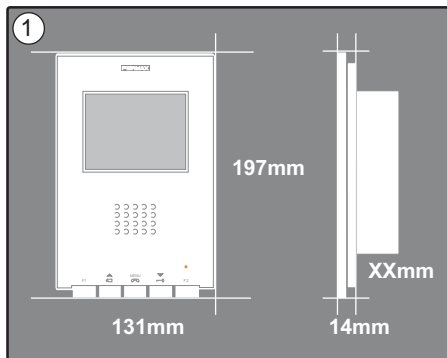

Dimensões do monitor (Altura x Largura x Prof *):

197 x 131 x 60 mm / 7,7" x 5,1" x 2,3"

Dimensões do monitor Pure (Altura x Largura x Prof *):

197 x 131 x 59 mm / 7,7" x 5,1" x 2,3"

Dimensões da caixa Fermax (Altura x Largura x Prof.):

158 x 108 x 45 mm / 6,2" x 4,2" x 1,7"

Dimensões da caixa universal (Altura x Largura x Prof.):

174 x 114 x 50 mm / 6,8" x 4,5" x 2"

Notas:

- este monitor pode ser instalado numa caixa universal.
- **Prof *** : A profundidade do Monitor foi considerada com a caixa Fermax

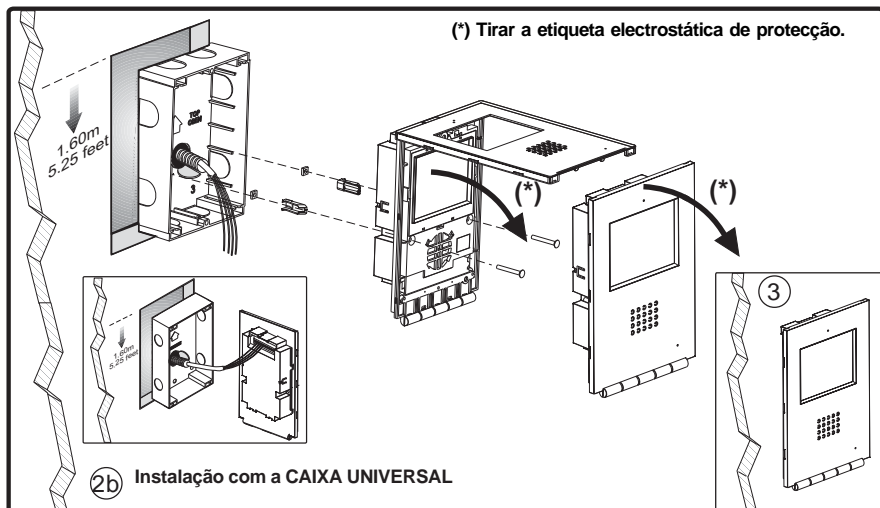
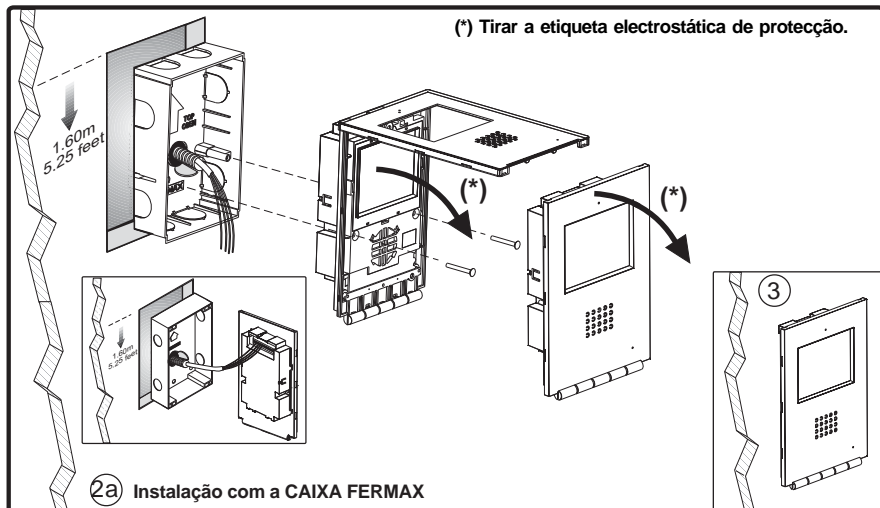

INSTALAÇÃO DE MONITOR DE SUPE

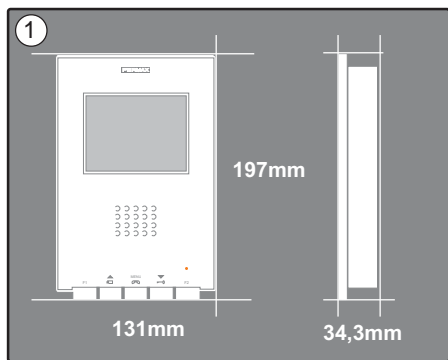

Dimensões do monitor (Altura x Largura x Prof.):
197 x 131 x 34,3 mm / 7,7" x 5,1" x 1,3"

Dimensões do monitor Pure (Altura x Largura x Prof.):
197 x 131 x 33,3 mm / 7,7" x 5,1" x 1,3"

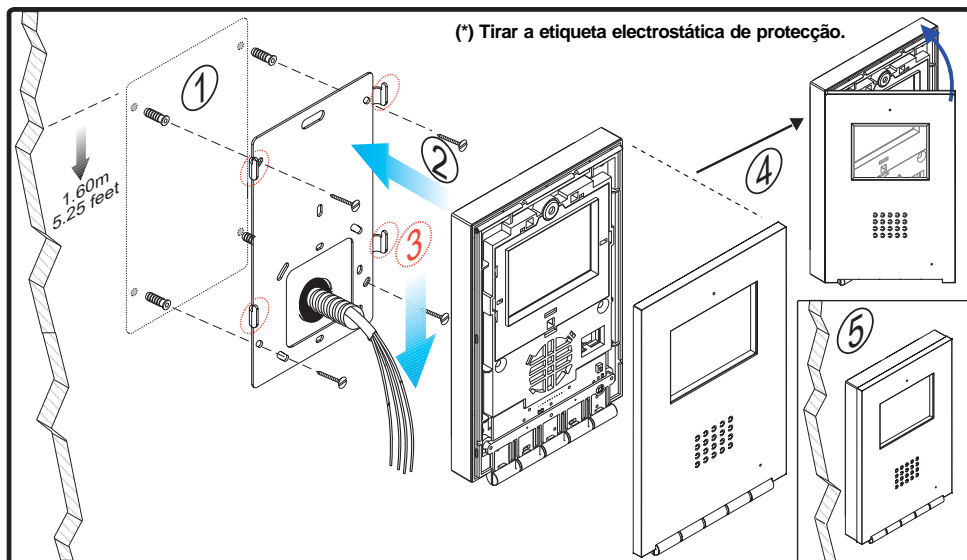

CONEXÕES

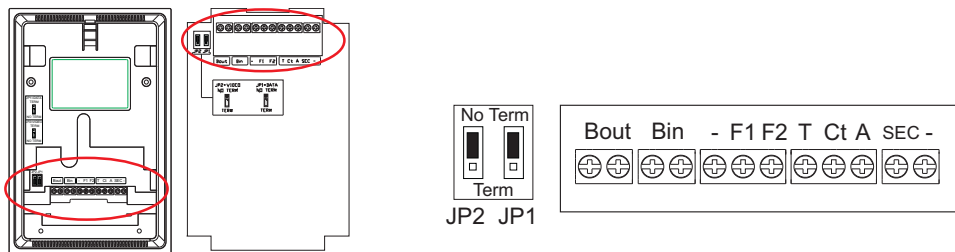

Superfície Encastrar

Bin	- Bus de comunicações áudio+vídeo (sem polaridade) - Conexão monitor/telefone adicional
Bout	Conexão seguinte monitor/telefone em cascata
F1, F2	Funções adicionais (saída negativo «-») Corrente máxima por botão F1,F2: 150mA
T, -	Conexão botão de chamada porta vivenda.
CT	Quando no monitor se activa o vídeo neste borne (parafusos) se gera uma tensão de 10Vdc (Activação camara auxiliar).
A, -	Conexão prolongador de chamada Ref. 2040.
SEC	Gera uma tensão de 12Vdc durante 5 segundos quando se recebe uma chamada no monitor.
JP1	Nas <i>instalações em cascata</i> : - Colocar a ponte JP1 na posição NO TERM nos monitores do primeiro andar e andares intermediarios. - Colocar a ponte JP1 na posição TERM no último monitor (último andar). Nas <i>instalações em distribuição</i> , colocar a ponte JP1 na posição NO TERM em todos os monitores.
JP2	- Quando só existe um monitor por vivenda, colocar a ponte JP2 na posição «NO TERM». - Se temos dois monitores (ou inclusive monitor e telefone), se deve colocar a ponte JP2 na posição «TERM» em ambos terminais.

CARACTERÍSTICAS TÉCNICAS

	Alimentação	24 Vdc		
	Consumo	SEM Circuito indutivo	COM Circuito indutivo ⚡	
		em repouso	36 mA	34 mA
		em chamada	350 mA	490 mA
		com vídeo	250 mA	330 mA
	com áudio e vídeo	390 mA	com áudio ao máximo 634 mA	
Temperatura de funcionamento			[5 , +40 °C] [41, +104 °F]	
Umidade			[0 - 90%]	
TFT	Ecrã Plana . 3,5" Diagonal			
Resolução:	Horizontal: 480 Line TV - Vertical: 234 Line TV			
Sinal de vídeo:	Sinal modulada 4,5 Vpp			
Dimensões do monitor de encastrar (Altura x Largura x Prof.):	197 x 131 x 60 mm / 7,7" x 5,1" x 2,3"			
Dimensões do monitor de encastrar Pure (Altura x Largura x Prof.):	197 x 131 x 59 mm / 7,7" x 5,1" x 2,3"			
Dimensões do monitor à superfície (Altura x Largura x Prof.):	197 x 131 x 34,3 mm / 7,7" x 5,1" x 1,3"			
Dimensões do monitor à superfície Pure (Altura x Largura x Prof.):	197 x 131 x 33,3 mm / 7,7" x 5,1" x 1,3"			

ESQUEMAS

Em cascata

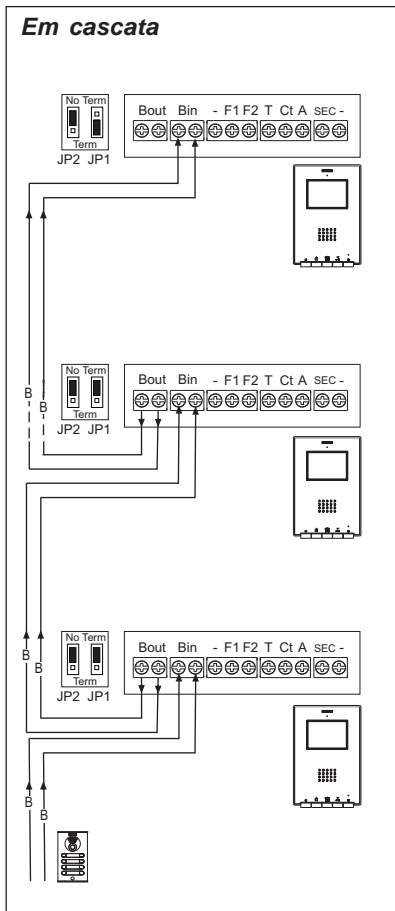

Em distribuição

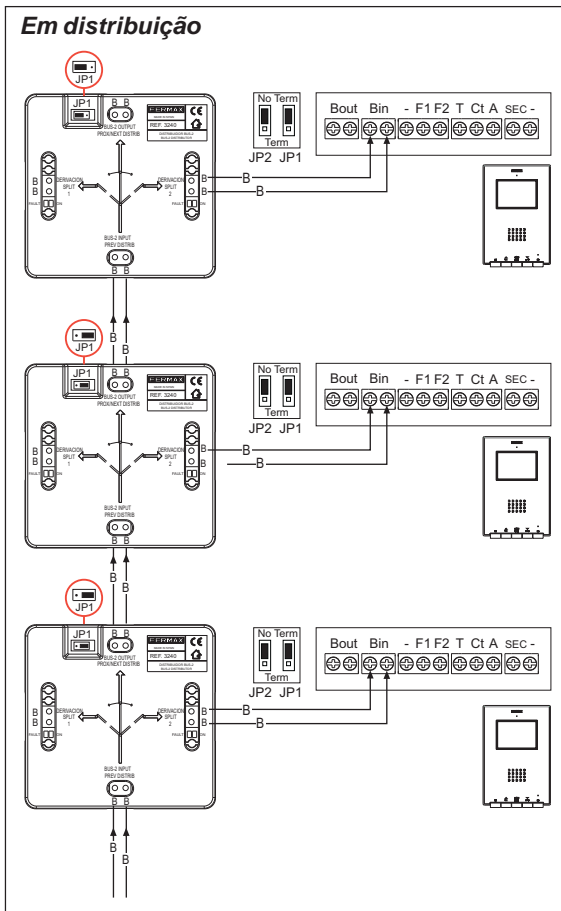

Monitor adicional

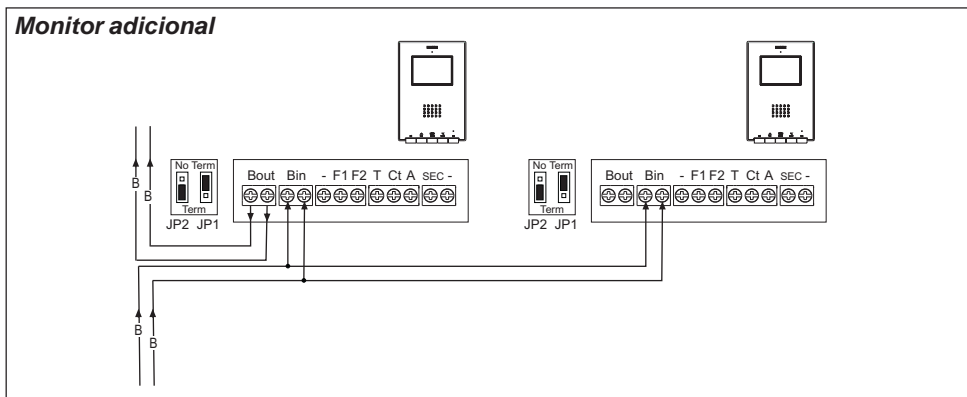

Nota: Configurar as pontes JP1 e JP2 tal como se explica na página anterior.

PROGRAMAÇÃO DO MONITOR ILOFT

1º. Entrar na programação

Opção 1

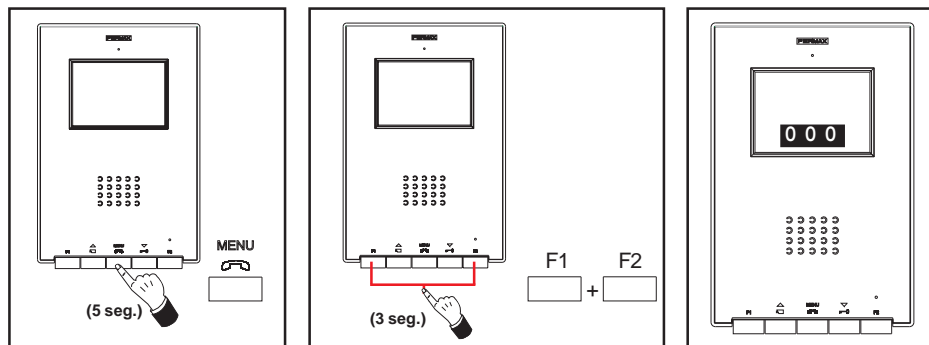

Com o monitor conectado:

- Premir o botão «MENU» durante 5 segundos. Se escuta a melódia programada para a placa principal.
- Premir os botões «F1» e «F2» simultaneamente durante 3 segundos. Se escuta um som de confirmação, a ecrã do monitor se activa e aparece num quadro a direcção actual do monitor.

O LED azul fixo.

Opção 2

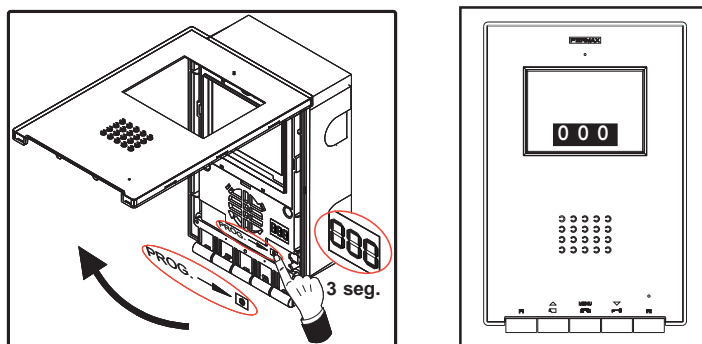

Com o monitor conectado:

- Pressionar o botão «PROG» durante 3 segundos. A ecrã do monitor se activa e mostra num quadro a direcção actual do monitor.

O LED azul fixo.

2º. Programar a direcção do monitor

Opção 1: Desde a placa da rua

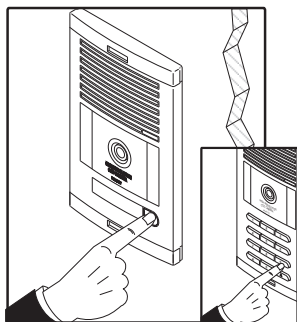

Premir o botão de chamada à vivenda (placas de botão) ou código de chamada (placas de teclado). Se produz a confirmação com tom de chamada e se visualiza na ecrã o número programado.

Opção 2: Desde o monitor

2.1- Premir o botão correspondente a centenas, dezenas ou unidades, para incrementar numa unidade o dígito correspondente (se visualiza na ecrã):

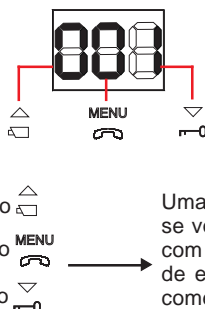
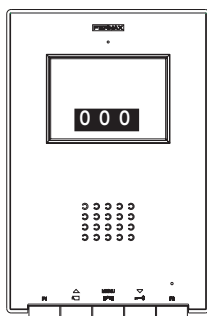

Centenas: Premir o botão

Dezenas: Premir o botão

Unidades: Premir o botão

Uma vez que se chega ao 9 e se volta a pressionar continua com o 0 e emite um tom grave de error. A seguinte pulsação começa desde o número 1.

2.2- Confirmar a direcção: premir os botões «F1» e «F2» simultaneamente durante 3 segundos até escutar um som de confirmação.

Se passam 90 segundos sem confirmar a direcção seleccionada, o monitor fica programado com a direcção que estava programada antes de entrar na programação.

PROGRAMAÇÃO DO MONITOR iLOFT como SECUNDÁRIO

1º. Entrar na programação

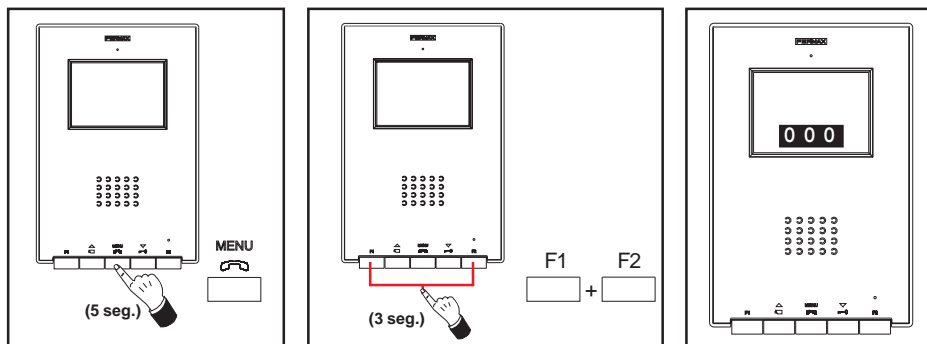

Com o monitor conectado:

- Premir o botão «MENU» durante 5 segundos. Se escuta a melódia programada para a placa principal.
- Premir os botões «F1» e «F2» simultaneamente durante 3 segundos. Se escuta um som de confirmação, a ecrã do monitor se activa e aparece num quadro a direcção actual do monitor.

O LED azul fixo.

2º. Programar a direcção do monitor desde o monitor

2.1- Premir o botão correspondente a centenas, dezenas ou unidades, para incrementar numa unidade o dígito correspondente (se visualiza na ecrã):

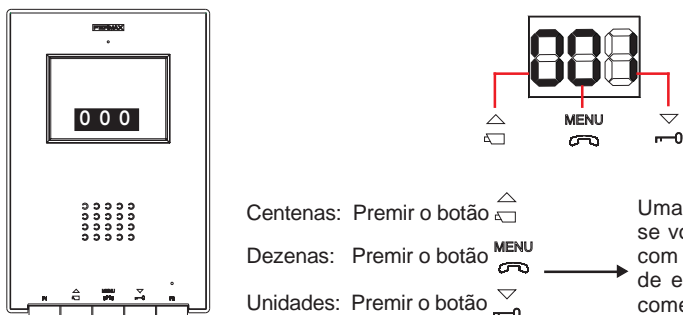

Centenas: Premir o botão

Dezenas: Premir o botão

Unidades: Premir o botão

Uma vez que se chega ao 9 e se volta a pressionar continua com o 0 e emite um tom grave de erro. A seguinte pulsação começa desde o número 1.

2.2- Carregar no botão «F2» até ouvir o som de confirmação.

2.3- Confirmar a direcção: premir os botões «F1» e «F2» simultaneamente durante 3 segundos até escutar um som de confirmação.

Se passam 90 segundos sem confirmar a direcção seleccionada, o monitor fica programado com a direcção que estava programada antes de entrar na programação.

FUNCIONAMENTO DO MONITOR iLOFT

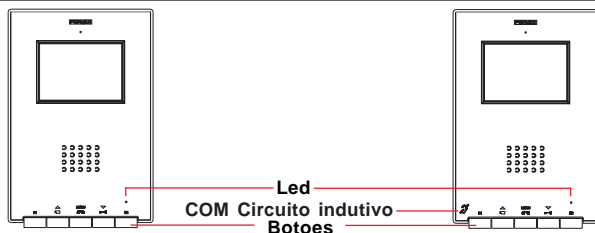

COM Circuito indutivo. Apresentam-se identificados por este símbolo.

- Inclui um circuito que interage com os dispositivos de audição de pessoas com incapacidade auditiva.
- **Nota:** nos dispositivos de audição com selecção manual de modo, deve estar configurado o Modo Digital.

Botoes



Botão Activação de Áudio, desligado e Ajustes de configuração (menú).

- Ao receber uma chamada premir este botão para falar com o visitante. Abre-se o canal de áudio no sentido rua e vivenda, o funcionamento é no modo mãos livres.
- Premir ao finalizar a comunicação.
- Com o monitor em repouso premir este botão, durante 3 segundos, para entrar no modo configuração do monitor. Ver ítem «Ajustes do Monitor».



Botão do trinco / chamada ao porteiro.

- Estando em conversação com a Placa da rua, ao premir este botão se activa o *trinco*.
- Com o monitor em repouso, ao premir este botão se realiza uma *chamada ao porteiro* (se existir portaria).



Botão de Auto-acendido / Selecção camara principal-secundaria.

- Com o monitor em repouso premir este botão durante 1 segundo para acender manualmente o monitor. Para activar áudio premir o botão .
- Com vídeo, manter pressionado este botão durante 2 segundos para seleccionar sequencialmente entre a camara principal e a secundaria (se existir).



F1 e F2: Botões para Funções Adicionais. (Asignadas pelo instalador).

Led

	Estado Led	Estado monitor
Vermelho	<i>Piscando 1 vez cada segundo.</i>	No modo programação.
	<i>Piscando 1 vez cada 2 segundos.</i>	Cancelação tom de chamada activado.
Verde	<i>Acesa a cor verde.</i>	Modo «Abertura automática» activado.
Verde Vermelho	<i>Acesa, alterna entre verde e vermelho.</i>	Cancelação tom de chamada e Modo «Abertura automática» activados.
Azul	<i>Acesa a cor azul.</i>	Comunicação estabelecida / Canal ocupado / ajustes.

Funcionamento

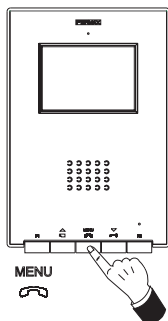

Atender uma chamada

Ao pressionar o botão de chamada, na **Placa da Rua** se produz um tom de chamada tanto na placa da rua como no monitor, acendendo a ecrã.

Premir o botón MENU para falar com o visitante. Se abre o canal de áudio no sentido rua e vivenda, o **funcionamento é no modo mãos livres**. A comunicação finalizará automaticamente aos 90 segundos ou a qualquer momento ao premir o botão MENU.

A luz permanecerá acesa (azul) durante o tempo que dure a conversação.

Se não se estabelece comunicação com a placa da rua, o monitor se apagará automaticamente após 30 seg.

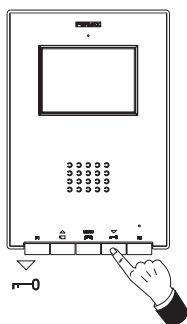

Abertura da porta

Ao receber uma chamada desde a placa da rua, é possível abrir a porta em qualquer momento, premindo o botão .

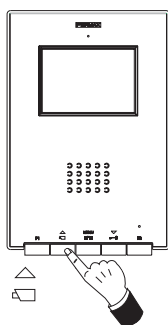

Activação Manual do Monitor (Auto-acendido)

Com o monitor em repouso premir este botão durante 1 segundo para acender manualmente o monitor. Para seleccionar sequencialmente entre a camara principal e secundaria (se existir) manter pressionado o botão durante 2 segundos.

Para activar o áudio e falar com o visitante ou abrir a porta realizar os passos descritos anteriormente.

Se não se estabelece comunicação com a placa da rua, o monitor se apagará automaticamente após 30 seg.

NOTAS:

A ecrã do monitor se acende uma vez finalizada a chamada desde a placa.

Se existe mais de um monitor iLoft na instalação e se realiza a chamada a um monitor, o resto dos monitores mostrará a luz na cor azul avisando que o canal está ocupado.

Funcionamento

Cancelar o tom da Chamada

Com o monitor em repouso, premir 3 vezes seguidas o botão  num tempo inferior a 2 segundos aproximadamente.

A luz vermelha pisca 1 vez a cada 2 segundos.

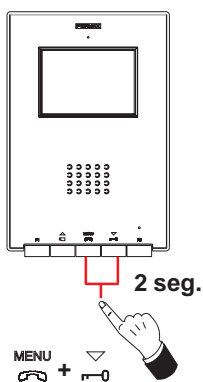
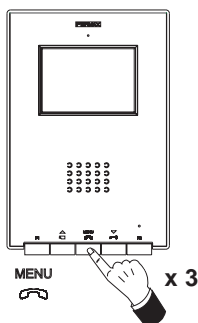

Para desactivar a cancelação do tom da chamada, premir novamente 3 vezes seguidas o botão  num tempo inferior a 2 segundos.

A luz volta ao seu estado anterior.





Modo «Abertura automática»

Com o modo «Abertura automática» activado, o monitor activa automaticamente o trinco aos 5 segundos de receber uma chamada desde a placa.

Para activar o modo «Abertura automática» premir simultaneamente, durante 2 segundos, os botões  + .

A luz permanece na cor verde.

Para desactivar o modo «Abertura automática» premir simultaneamente, durante 2 segundos, os botões  + .

A luz volta ao seu estado anterior.

Nota: Se ao mesmo tempo estão activadas a «cancelação do tom de chamada» e a «abertura automática», a luz do monitor alternará entre vermelho e verde a cada segundo.

Ajuste do Volume de Áudio

Estando em comunicação com placa da rua, manter pressionado o botão , até que apareça na ecrã o menú:



sn 3

- premir o botão  para aumentar o *nível do áudio*.

- premir o botão  para diminuir o *nível do áudio*.

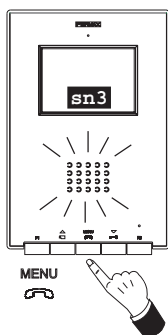
(Existem 5 níveis seleccionáveis de áudio: sn1..sn5)



É possível estabelecer comunicação com a placa da rua sem necessidade de receber uma chamada da placa, realizando «**Auto-acendido**» (premir ) e pressionando posteriormente o botão .

AJUSTES DO MONITOR iLOFT

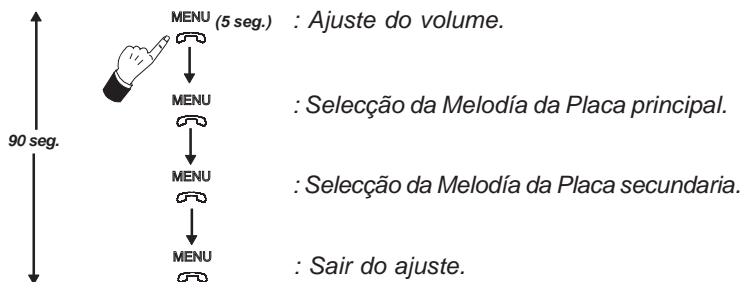
Ajuste do Volume e Selecção de Melodías

- **Acesso ao modo «ajuste do volume»:** premir o botão «» 5 segundos. (a luz piscará 1 vez por segundo e se escutará o tom de chamada da placa principal).

O monitor iLoft dispõe de 5 níveis de volume diferentes:

- premir o botão para aumentar o volume.
- premir o botão para diminuir o volume.

Uma vez alcançado o maior ou menor dos níveis de volume se escuta um som duplo indicando que se alcançou o nível máximo ou mínimo.

- Acesso ao modo «selecção de melodía»

Melodía para chamada procedente da Placa Principal:

Estando no modo «ajuste de volume» premir o botão «» até escutar novamente o tom de chamada da placa principal.

- premir o botão para seleccionar a melodía seguinte.
- premir o botão para seleccionar a melodía anterior.

Melodía para chamada procedente da Placa Secundaria:

Estando no modo «selecção de melodía para a Placa Principal» premir o botão «» até escutar novamente o tom de chamada da placa principal.

- premir o botão para seleccionar a melodía seguinte.
- premir o botão para seleccionar a melodía anterior.

- Sair de «ajuste do volume e selecção de melodía»

Estando no modo «selecção de melodía para a Placa Secundaria» premir o botão «» até escutar um tom largo de confirmação.

Ajuste da Imagen (contraste, brilho e cor)

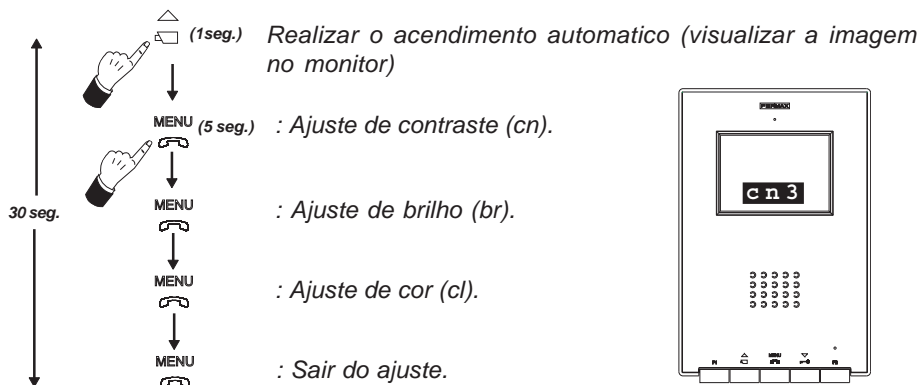

O monitor ILOFT, dispõe de 5 níveis pré-definidos para os ajustes de contraste, brilho e cor.

- Acesso ao modo «ajuste de contraste»:

- 1- Realizar auto-acendido automatico: Premir o botão △ até visualizar a imagem na ecrã.
- 2- premir o botão «^{MENU} MENU» 5 segundos.

Se escuta um som de confirmação e aparece na ecrã o menú de ajuste de contraste.

cn 3 - premir o botão △ para aumentar o *nível de contraste*.
 - premir o botão ▽ para diminuir o *nível de contraste*.

- Acesso ao modo «ajuste de brilho»:

Estando no modo «ajuste de contraste» premir o botão «^{MENU} MENU»:

br 5 - premir o botão △ para aumentar o *nível de brilho*.
 - premir o botão ▽ para diminuir o *nível de brilho*.

- Acesso ao modo «ajuste de cor»:

Estando no modo «ajuste de brilho» premir o botão «^{MENU} MENU»:

cl 5 - premir o botão △ para aumentar o *nível de cor*.
 - premir o botão ▽ para diminuir o *nível de cor*.

- **Sair de «ajuste de imagen»:** Estando no modo «ajuste de cor» premir o botão «^{MENU} MENU».

Nota: Se o monitor se apaga porque passou dos 30 segundos de programação, se guardam os últimos valores mostrados na ecrã para cada ajuste.

INSTALLAZIONE MONITOR INCASSATO

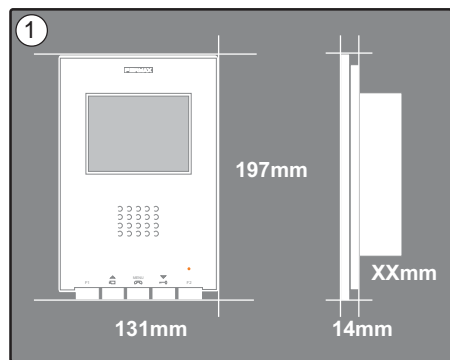

Dimensioni monitor (Altezza x Larghezza x Profondità *):

197 x 131 x 60 mm / 7,7" x 5,1" x 2,3"

Dimensioni monitor Pure (Altezza x Larghezza x Profondità *):

197 x 131 x 59 mm / 7,7" x 5,1" x 2,3"

Dimensioni cassa Fermax (Altezza x Larghezza x Profondità):

158 x 108 x 45 mm / 6,2" x 4,2" x 1,7"

Dimensioni cassa universale (Altezza x Larghezza x Profondità):

174 x 114 x 50 mm / 6,8" x 4,5" x 2"

Note:

- questo monitor può essere installato in una cassa universale.

- **Prof *** : la profondità del Monitor è stata considerata con cassa Fermax

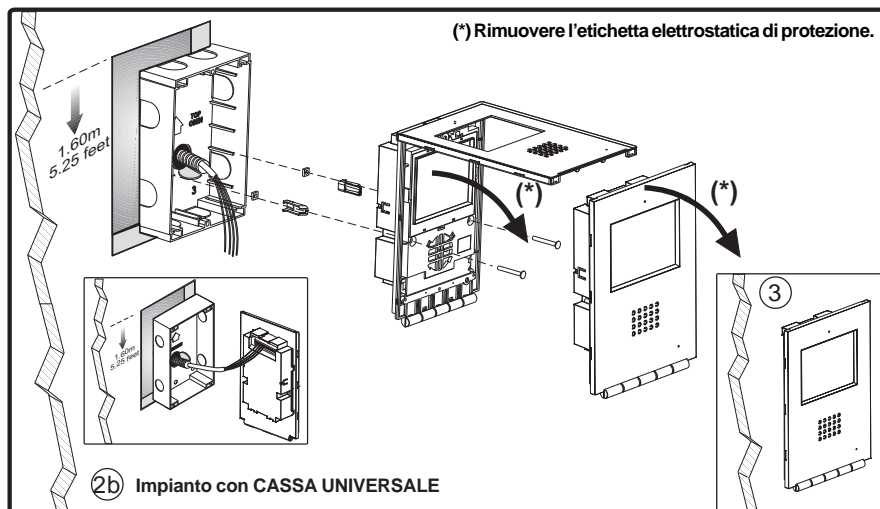
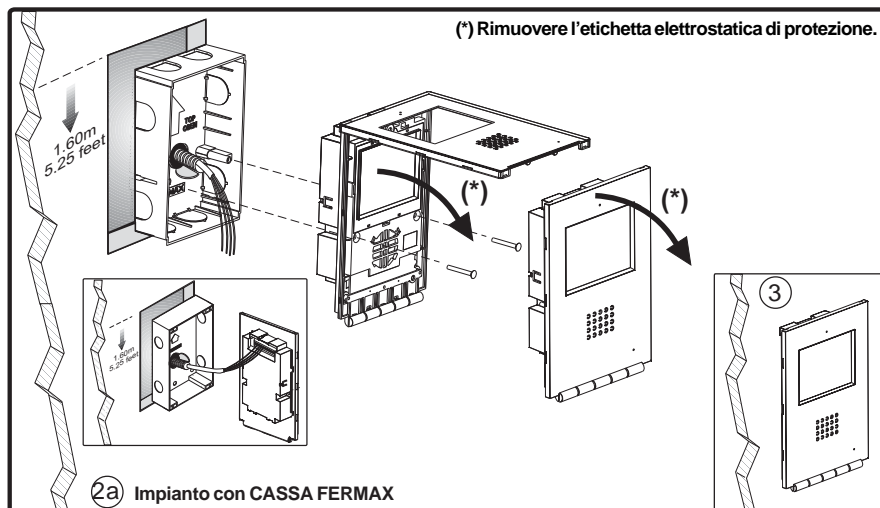

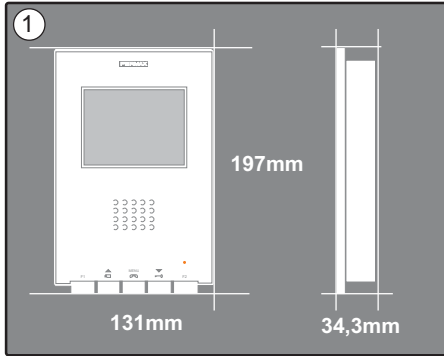
INSTALLAZIONE MONITOR SUPERFICIE

Dimensioni monitor (Altezza x Larghezza x Profondità):
197 x 131 x 34,3 mm / 7,7" x 5,1" x 1,3"

Dimensioni monitor Pure (Altezza x Larghezza x Profondità):
197 x 131 x 33,3 mm / 7,7" x 5,1" x 1,3"

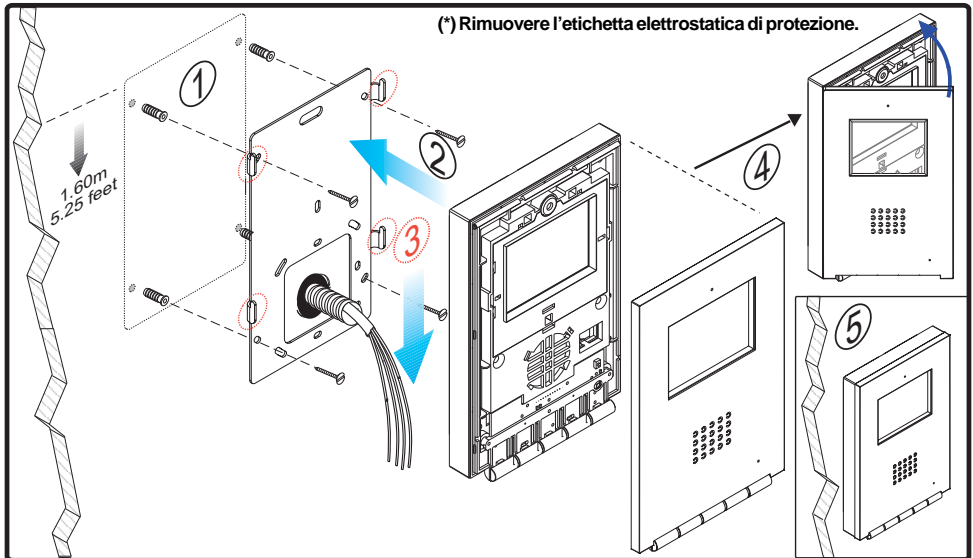

(*) Rimuovere l'etichetta elettrostatica di protezione.

CONNESSIONI

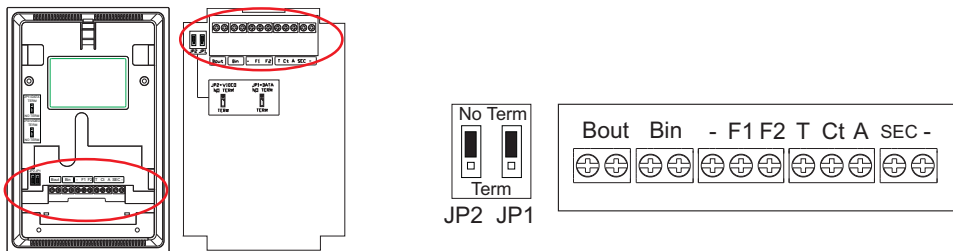

Superficie Incassare

Bin	- Bus di comunicazioni audio+video (senza polarità) - Connessione monitor/citofono supplementare
Bout	Connessione seguente monitor/citofono a cascata
F1, F2	Funzioni supplementari (uscita negativo «-») Corrente massima mediante pulsante F1,F2: 150mA
T, -	Connessione pulsante di chiamata porta appartamento
CT	Quando sul monitor si attiva il video, in questo morsetto si genera una tensione di 10Vcc (Attivazione telecamera ausiliare).
A, -	Connessione prolungamento chiamata Rif. 2040.
SEC	Genera una tensione di 12 Vcc per 5 secondi quando si riceve una chiamata nel monitor.

JP1	In <i>impianti a cascata</i> : - Collocare il ponte JP1 nella posizione NO TERM nei monitor del primo piano e dei piani intermedi. - Collocare il ponte JP1 nella posizione TERM nell'ultimo monitor (ultimo piano). In <i>impianti in distribuzione</i> , collocare il ponte JP1 nella posizione NO TERM in tutti i monitor.
JP2	- Quando esiste un solo monitor per appartamento, collocare il ponte JP2 nella posizione «NO TERM». - Con due monitor (o anche monitor e citofono), il ponte JP2 deve essere collocato nella posizione «TERM» in entrambi i terminali.

CARATTERISTICHE TECNICHE

	Alimentazione	24 Vdc		
	Consumo	SENZA loop induttivo	CON loop induttivo ⚡	
		in standby	36 mA	34 mA
		in chiamata	350 mA	490 mA
		con video	250 mA	330 mA
	con audio e video	390 mA	con audio al massimo 634 mA	
Temperatura di funzionamento			[5, +40 °C] [41, +104 °F]	
Umidità:			[0 - 90%]	
TFT	Schermo piatto. 3,5" Diagonale			
Risoluzione:	Orizzontale: 480 Line TV - Verticale: 234 Line TV			
Segnale video:	Segnale modulato 4,5 Vpp			
Dimensioni monitor da incasso (Altezza x Larghezza x Prof.):	197 x 131 x 60 mm / 7,7" x 5,1" x 2,3"			
Dimensioni monitor da incasso Pure (Altezza x Larghezza x Prof.):	197 x 131 x 59 mm / 7,7" x 5,1" x 2,3"			
Dimensioni monitor superficie (Altezza x Larghezza x Prof.):	197 x 131 x 34,3 mm / 7,7" x 5,1" x 1,3"			
Dimensioni monitor superficie Pure (Altezza x Larghezza x Prof.):	197 x 131 x 33,3 mm / 7,7" x 5,1" x 1,3"			

SSCHEMI

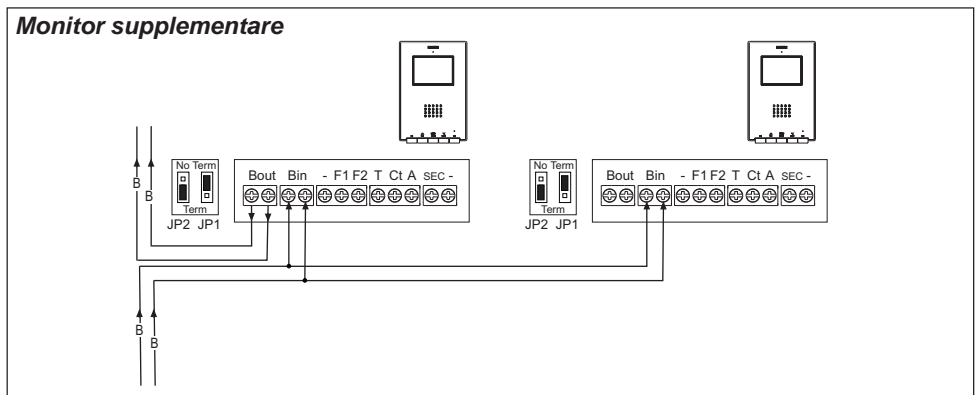
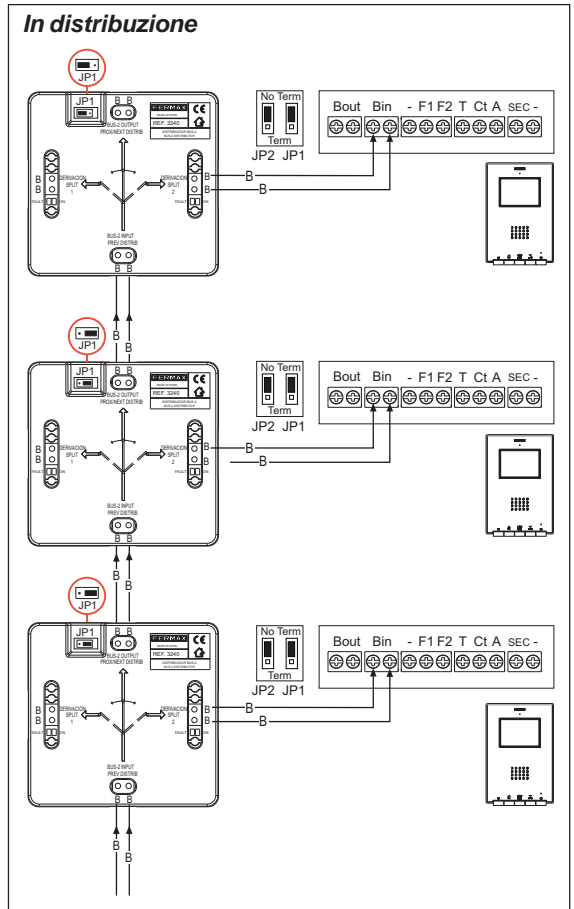
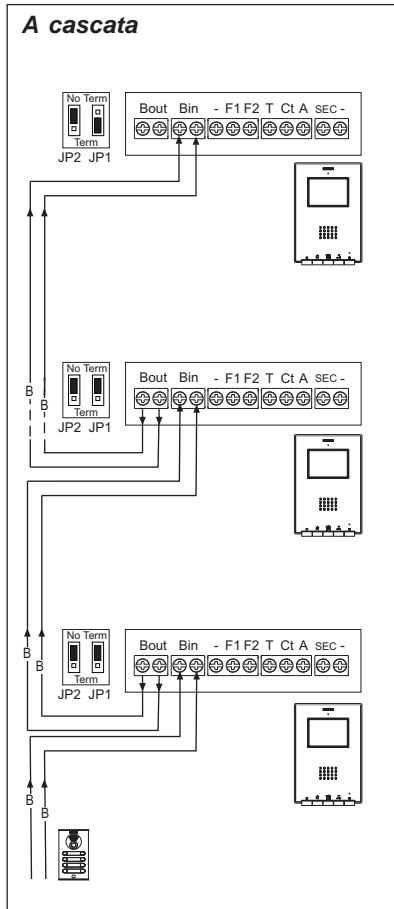

Nota: Configurare i ponti JP1 e JP2 come illustrato nella pagina precedente.

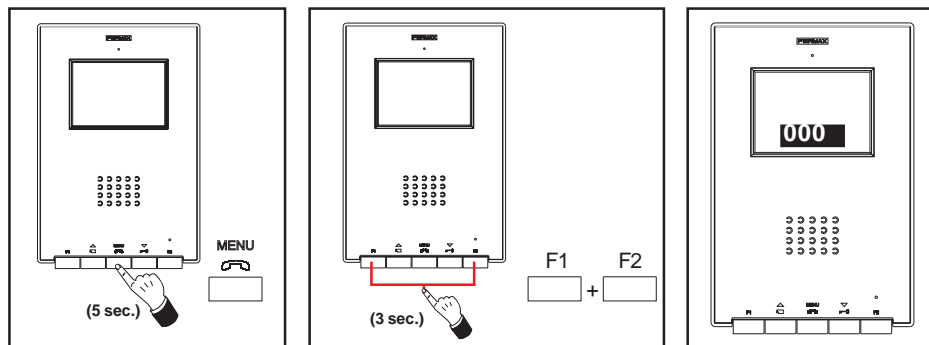
PROGRAMMAZIONE DEL MONITOR iLOFT**1°. Entrare in modalità programmazione****Opzione 1**

Con il monitor collegato:

- Premere il pulsante «MENU» per 5 secondi. Si udirà la melodia programmata per il posto principale
- Premere i pulsanti «F1» e «F2» simultaneamente per 3 secondi. Si ode un suono di conferma, lo schermo del monitor si attiva e viene visualizzata in un riquadro la direzione attuale del monitor.

Il led blu fisso.

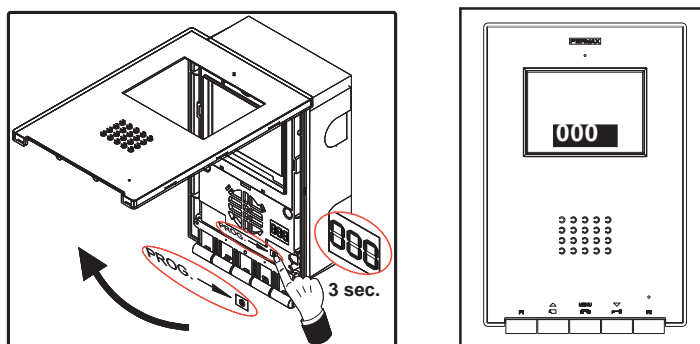
Opzione 2

Con il monitor collegato:

- Premere il pulsante «PROG» per 3 secondi. Lo schermo del monitor si attiva e viene visualizzata in un riquadro la direzione attuale del monitor.

Il led blu fisso.

2°. Programmare la direzione del monitor

Opzione 1: Dal posto esterno

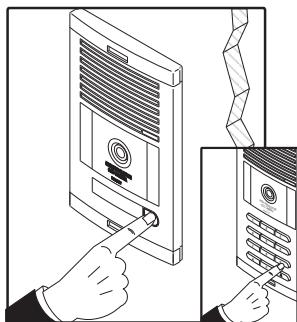

Premere il pulsante di chiamata all'appartamento (posto dei pulsanti) o codice di chiamata (posto pulsantiera). Si ode una conferma con tono di chiamata e si visualizza sullo schermo il numero programmato.

Opzione 2: Dal monitor

2.1- Premere il pulsante corrispondente a centinaia, decine o unità, per incrementare di un'unità la cifra corrispondente (si visualizza sullo schermo):

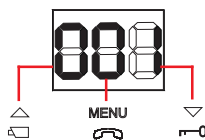
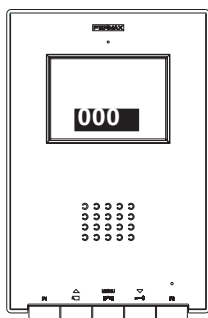

Centinaia: Premere il pulsante

Decine: Premere il pulsante

Unità: Premere il pulsante

Una volta si arriva al 9 e si preme nuovamente continua con lo 0 ed emette un tono grave di errore. La digitazione seguente inizia dal numero 1.

2.2- Confermare la direzione: premere i pulsanti «F1» e «F2» simultaneamente per 3 secondi fino al suono di conferma.

Se trascorrono 90 secondi senza conferma della direzione selezionata, il monitor rimane programmato con la direzione che era programmata prima di entrare nella fase di programmazione.

PROGRAMMAZIONE DEL MONITOR iLOFT come SECONDARIO

1º. Entrare in modalità programmazione

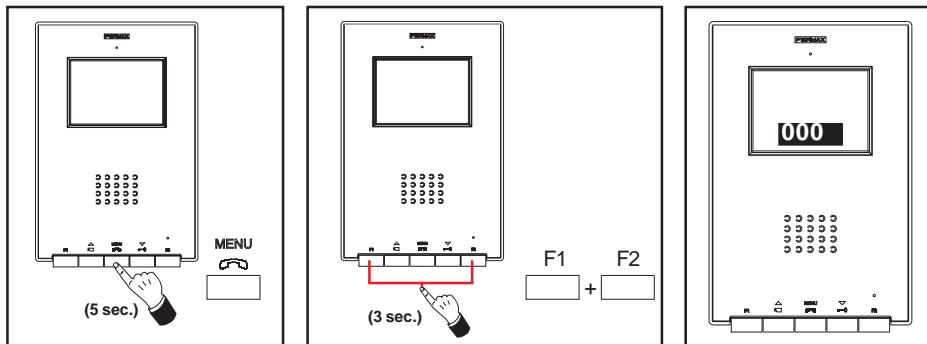

Con il monitor collegato:

- Premere il pulsante «MENU» per 5 secondi. Si udirà la melodia programmata per il posto principale
- Premere i pulsanti «F1» e «F2» simultaneamente per 3 secondi. Si ode un suono di conferma, lo schermo del monitor si attiva e viene visualizzata in un riquadro la direzione attuale del monitor.

Il led blu fisso.

2º. Programmare la direzione del monitor dal monitor

2.1- Premere il pulsante corrispondente a centinaia, decine o unità, per incrementare di un'unità la cifra corrispondente (si visualizza sullo schermo):

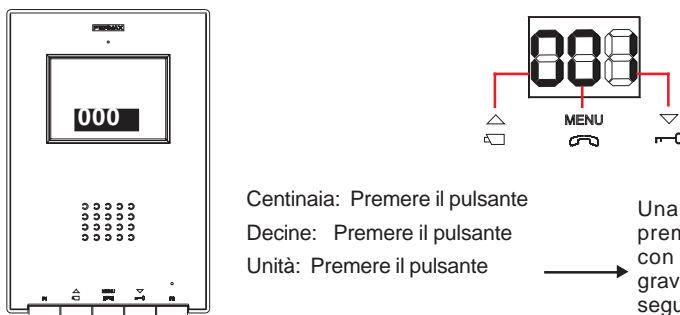

Centinaia: Premere il pulsante

Decine: Premere il pulsante

Unità: Premere il pulsante

Una volta si arriva al 9 e si preme nuovamente continua con lo 0 ed emette un tono grave di errore. La digitazione seguente inizia dal numero 1.

2.2- Premere il pulsante «F2» fino ad udire il segnale di conferma.

2.3- Confermare la direzione: premere i pulsanti «F1» e «F2» simultaneamente per 3 secondi fino al suono di conferma.

Se trascorrono 90 secondi senza conferma della direzione selezionata, il monitor rimane programmato con la direzione che era programmata prima di entrare nella fase di programmazione.

FUNZIONAMENTO MONITOR iLOFT



CON loop induttivo. Vengono identificati con questo simbolo.

- Include un loop che interagisce con i dispositivi di ascolto delle persone con problemi di udito.
- **Nota:** nei dispositivi di ascolto con selezione manuale della modalità, è necessario configurare la Modalità digitale.

Pulsanti

Pulsante attivazione Audio, Blocco e Impostazione della configurazione (menu).

- Quando si riceve una chiamata, premere questo pulsante per parlare con il visitatore. Si apre il canale audio in direzione esterno e appartamento, il funzionamento si trova in modalità mani libere.
- Premere una volta conclusa la comunicazione.
- Con il monitor in standby, premere questo pulsante per 3 secondi, per entrare in modalità configurazione del monitor. V. paragrafo «Impostazioni del Monitor».



Pulsante apriporta / chiamata portineria.

- Durante la conversazione con il Posto Esterno, premendo questo pulsante si attiva l'apriporta.
- Con il monitor in standby, premendo questo pulsante di esegue una *chiamata alla portineria* (se esiste portineria).



Pulsante di accensione automatica / Selezione telecamera principale-secondaria.

- Con il monitor in standby, premere questo pulsante per 1 secondo per accendere manualmente il monitor. Per attivare audio premere il pulsante.
- Con video, tenere premuto questo pulsante per 2 secondi per selezionare sequenzialmente tra la telecamera principale e secondaria (se esiste).

F1 F1 e F2: Pulsanti per Funzioni Aggiuntive. (Assegnate dall'installatore).



Led

	Stato Led	Stato monitor
Rosso	Lampeggiamento 1 volta al secondo	In modalità programmazione
	Lampeggiamento 1 volta ogni 2 secondi	Annullamento tono di chiamata attivato
Verde	Accensione colore verde	Modalità «Apertura automatica» attivata
Verde Rosso	Accensione, alternanza tra verde e rosso	Annullamento tono di chiamata e Modalità «Apertura automatica» attivati
Blu	Accensione colore blu	Comunicazione stabilita / Canale occupato / impostazioni

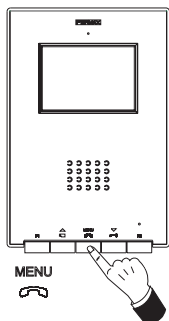
FUNZIONAMENTO

**Rispondere a una chiamata**

Quando si preme il pulsante di chiamata, nel **Posto Esterno** si ode un tono di chiamata sia nel posto esterno sia nel monitor, e si accende lo schermo.

Premere il pulsante  per parlare con il visitatore. Si apre il canale audio in direzione esterno e appartamento, il **funzionamento si trova in modalità mani libere**. La comunicazione terminerà automaticamente dopo 90 secondi o in qualsiasi momento premendo il pulsante .

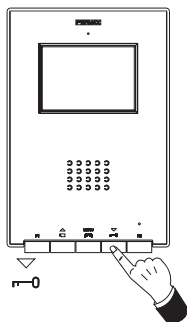

Il led rimarrà acceso (blu) per il tempo di durata della conversazione.

Se non si stabilisce comunicazione con il posto esterno, il monitor si spegne automaticamente trascorsi 30 sec.

**Apertura porta**

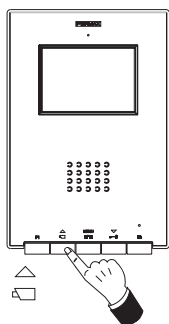
Quando si riceve una chiamata dal posto esterno, è possibile aprire la porta in qualunque momento, premuto il pulsante .

**Attivazione Manuale del Monitor (accensione automatica)**

Con il monitor in standby, premere questo pulsante  per 1 secondo per accendere manualmente il monitor. Per selezionare sequenzialmente tra la telecamera principale e secondaria (se esiste) tenere premuto questo pulsante  per 2 secondi.

Per attivare l'audio e parlare con il visitatore oppure aprire la porta realizzare le operazioni descritte in precedenza.

Se non si stabilisce comunicazione con il posto esterno, il monitor si spegne automaticamente trascorsi 30 sec.

NOTE:

Lo schermo del monitor si accende una volta conclusa la chiamata dal posto esterno.

Se esiste più di un monitor iLoft nell'impianto e si esegue la chiamata a un monitor, i restanti monitor mostreranno il led di colore blu avvisando che il canale è occupato.

FUNZIONAMENTO

Annullare tono di chiamata

Con il monitor in standby, premere 3 volte di seguito il pulsante  in un tempo inferiore a circa 2 secondi.



Il led rosso lampeggia 1 volta ogni 2 secondi.

Per disattivare l'annullamento del tono di chiamata, premere nuovamente 3 volte di seguito il pulsante  in un tempo inferiore a 2 secondi.

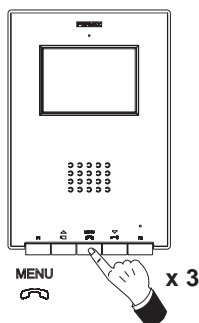

Il led torna allo stato precedente.

**Modalità «Apertura automatica»**

Con la modalità «Apertura automatica» attivata, il monitor attiva automaticamente l'apriporta dopo 5 secondi dalla ricezione di una chiamata dal posto esterno.

Per attivare la modalità «Apertura automatica», premere simultaneamente, per 2 secondi, i pulsanti  + .

Il led rimane di colore verde.

Per disattivare la modalità «Apertura automatica», premere simultaneamente, per 2 secondi, i pulsanti  + .



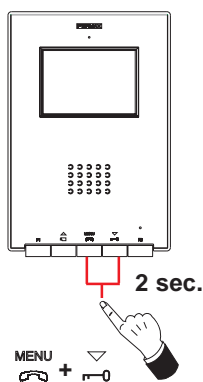

Il led torna allo stato precedente.



Nota: Se nello stesso tempo sono attivate la «cancellazione del tono di chiamata» e l'«apertura automatica», il led del monitor alternerà rosso e verde ogni secondo.

Impostazioni Volume Audio

Nella comunicazione con il posto esterno, tenere premuto il pulsante  fino a quando sarà visualizzato sullo schermo il menu:

-  - premere il pulsante  per aumentare il *livello di audio*.
-  - premere il pulsante  per diminuire il *livello di audio*.

(Esistono 5 livelli selezionabili di audio: sn1..sn5)

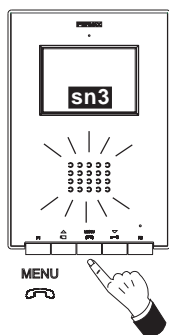



E' possibile stabilire comunicazione con il posto esterno senza necessità di ricevere una chiamata dal posto esterno «**Accensione automatica**» (premere  e premendo successivamente il pulsante



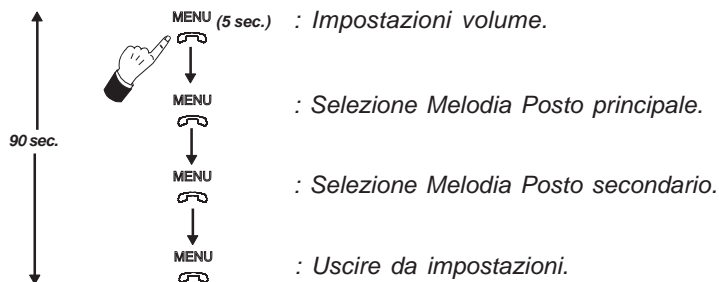

IMPOSTAZIONI MONITOR iLOFT

Impostazioni volume e selezione melodie



- **Accesso alla modalità «impostazioni volume»:** Premere il pulsante «» 5 secondi. (il led lampeggia 1 volta al secondo e si ode il tono di chiamata dal posto principale).

Il monitor iLoft dispone di 5 livelli di volume distinti:



- premere il pulsante  per aumentare il volume.
- premere il pulsante  per diminuire il volume.

Una volta raggiunto il maggiore o minore dei livelli di volume, si ode un suono doppio che indica il raggiungimento del livello massimo o minimo.

- **Accesso alla modalità «selezione melodia»**



Melodia per chiamata proveniente da Posto Principale:

In modalità «impostazioni volume» premere il pulsante «» fino a udire nuovamente il tono di chiamata del posto principale.

- premere il pulsante  per selezionare la melodia seguente.
- premere il pulsante  per selezionare la melodia precedente.

Melodia per chiamata proveniente da Posto Secondario:

In modalità «selezione melodia per Posto Principale» premere il pulsante «» fino a udire nuovamente il tono di chiamata del posto principale.

- premere il pulsante  per selezionare la melodia seguente.
- premere il pulsante  per selezionare la melodia precedente.

- **Uscire da «impostazioni volume e selezione melodia»**

In modalità «selezione melodia per Posto Secondario» premere il pulsante «» fino a udire un lungo suono di conferma.

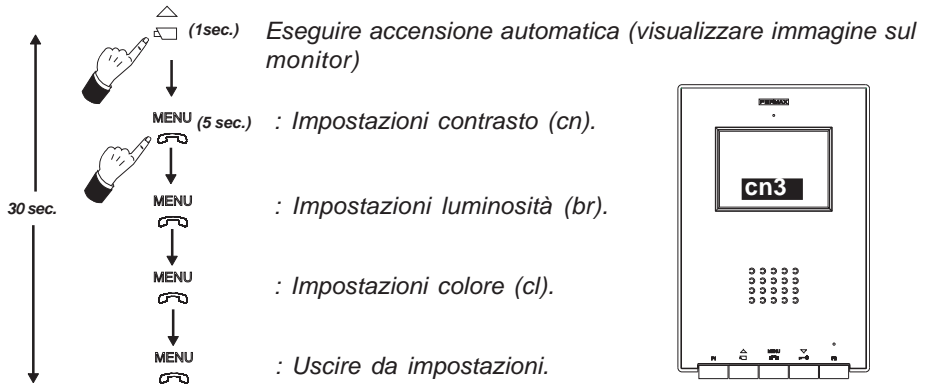
Impostazioni Immagine (contrasto, luminosità, colore)

Il monitor ILOFT, dispone di 5 livelli predefiniti per le impostazioni di contrasto, luminosità e colore.

- Accesso alla modalità «impostazioni contrasto»:

- 1- Eseguire accensione automatica: Premere il pulsante △ fino a visualizzare l'immagine sullo schermo.
- 2- premere il pulsante «^{MENU}» 5 secondi.

Si ode un suono di conferma, e sullo schermo è visualizzato il menu di impostazioni contrasto.

- cn 3**
- premere il pulsante △ per aumentare il *livello del contrasto*.
 - premere il pulsante ▽ per diminuire il *livello del contrasto*.

- Accesso alla modalità «impostazioni luminosità»:

In modalità «impostazioni contrasto» premere il pulsante «^{MENU}»:

- br 5**
- premere il pulsante △ per aumentare il *livello della luminosità*.
 - premere il pulsante ▽ per diminuire il *livello della luminosità*.

- Accesso alla modalità «impostazioni colore»:

In modalità «impostazioni luminosità» premere il pulsante «^{MENU}»:

- cl 5**
- premere il pulsante △ per aumentare il *livello del colore*.
 - premere il pulsante ▽ per diminuire il *livello del colore*.

- Uscire da «impostazioni immagine»: In modalità «impostazioni colore» premere il pulsante «^{MENU}».

Nota: Se il monitor si spegne perché sono trascorsi i 30 secondi di programmazione, vengono salvati gli ultimi valori visualizzati sullo schermo per ogni impostazione.

MANTENIMIENTO (LIMPEZA) - MAINTENANCE (CLEANING) - MAINTENANCE (NETTOYAGE) - WARTUNG (REINIGUNG) - MANUTENÇÃO (LIMPEZA) - MANUTENZIONE(PULIZIA)



- E** No utilizar productos de limpieza que contengan ácidos, vinagre o que sean abrasivos.
- EN** Do not use cleaning products which contain acids, vinegar or are abrasive in nature.
- F** Ne pas utiliser de produits nettoyants contenant de l'acide, du vinaigre ou d'autres substances abrasives.
- D** Verwenden Sie niemals säurehaltige oder scheuernde Reinigungsmittel.
- P** Não utilizar produtos de limpeza que contenham ácidos, vinagre, ou que sejam abrasivos.
- IT** Non utilizzare prodotti di pulizia che contengano acidi, aceto o che siano abrasivi.

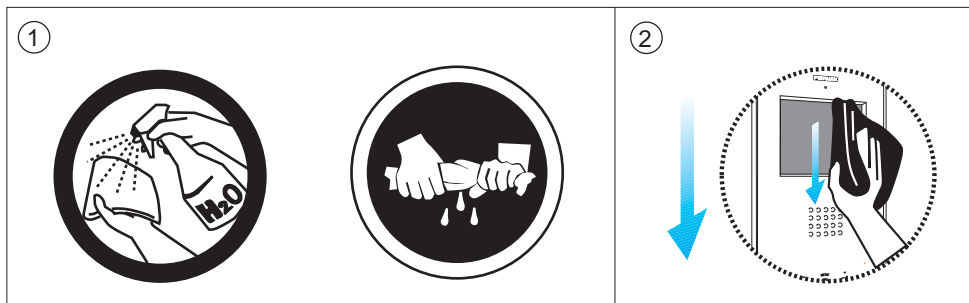

- E**
 - 1º. Utilizar trapo húmedo.
 - 2º. Páselo sobre el monitor siempre en la misma dirección.
Después de limpiar el monitor séquelo cuidadosamente para eliminar la humedad.
- EN**
 - 1º. Use a damp cloth.
 - 2º. Wipe it over the monitor always following the same direction.
After cleaning the monitor dry it carefully to avoid moisture damage.
- F**
 - 1º. Utiliser un chiffon humide.
 - 2º. Le passer sur le moniteur toujours dans le même sens.
Après avoir nettoyé le moniteur, le sécher soigneusement afin d'éliminer l'humidité.
- D**
 - 1º. Benutzen Sie ein feuchtes Reinigungstuch.
 - 2º. Fahren Sie immer in gleicher Richtung über den Monitor.
Nach der Monitorreinigung diesen vorsichtig trocken reiben.

- P**
- 1º. Utilizar um pano húmido.
 - 2º. Passe-o no monitor sempre na mesma direcção.
Após limpar o monitor, seque-o cuidadosamente, para eliminar a humidade.
- IT**
- 1º. Utilizzare uno panno umido.
 - 2º. Passarlo sopra il monitor sempre nella stessa direzione.
Dopo la pulizia del monitor, asciugarlo accuratamente per eliminare l'umidità.

FERMAX

Audio and Video Door Entry Systems

- E** Publicación técnica de carácter informativo editada por FERMAX ELECTRONICA.
FERMAX ELECTRONICA, en su política de mejora constante, se reserva el derecho a modificar el contenido de este documento así como las características de los productos que en él se refieren en cualquier momento y sin previo aviso.
Cualquier modificación será reflejada en posteriores ediciones de este documento.
- EN** Technical document published for information purposes by FERMAX ELECTRONICA.
FERMAX ELECTRONICA, in a policy of ongoing improvement, reserves the right to modify the contents of this document and the features of the products referred to herein at any time and with no prior notice. Any such modifications shall be reflected in subsequent editions of this document.
- F** Publication technique à caractère informatif éditée par FERMAX ELECTRONICA.
Conformément à sa politique de perfectionnement continu, FERMAX ELECTRONICA, se réserve le droit de modifier, à tout moment et sans préavis, le contenu de ce document ainsi que les caractéristiques des produits auxquels il fait référence. Toutes les modifications seront indiquées dans les éditions suivantes.
- D** Technische Veröffentlichung zu Informationszwecken; Herausgeber: FERMAX ELECTRONICA.
FERMAX ELECTRONICA, behält sich das Recht vor, den Inhalt dieses Dokuments sowie die technischen Eigenschaften der erwähnten Produkte ohne vorherige Ankündigung zu ändern, um dadurch den ständigen Weiterentwicklungen und den damit in Verbindung stehenden Verbesserungen Rechnung zu tragen. Alle Änderungen finden Aufnahme in den Neuauflagen dieses Dokuments.
- P** Publicação técnica de carácter informativo editada por FERMAX ELECTRONICA.
A FERMAX ELECTRONICA, na sua política de melhoramento constante, reserva-se o direito de modificar o conteúdo deste documento assim como as características dos produtos que nele são referidos a qualquer momento e sem aviso prévio.
Qualquer modificação será apresentada em edições posteriores deste documento.
- IT** Pubblicazione tecnica di carattere informativo edita da FERMAX ELECTRONICA.
FERMAX ELECTRONICA, nella sua politica di miglioramento costante, si riserva il diritto di modificare il contenuto del presente documento, così come le caratteristiche dei prodotti in esso menzionati in qualsiasi momento e senza preavviso.
Qualsiasi modifica sarà riportata in successive edizioni del presente documento.

Avda. Tres Cruces, 133 • 46017 Valencia (España)
Telf. 96 317 80 00 • Fax 96 377 07 50
Telf. Export: 00 34 96 317 80 02
www.fermax.com • fermax@fermax.com