

PLEASE NOTE:
64 MONITORS MAX. 100 MONITORS
MAX USING A XAS/301 BOOSTER.

PLEASE NOTE:
DRAWING INDICATES AND ASSUMES THAT
EACH MONITOR IS INDIVIDUALLY CALLED.

**PLEASE NOTE THE MAXIMUM DISTANCE BETWEEN
ENTRY PANEL AND FURTHEST MONITOR CANNOT EXCEED**
150M MAX USING VCM2D + VCM/1D OR
100M MAX USING CAT5 + 2 CORES @1.0MMSQ

**PLEASE NOTE THE MAXIMUM AMOUNT OF CABLE USED
ON THIS INSTALLATION MUST NOT EXCEED**
600M MAX USING VCM2D + VCM/1D OR
400M MAX USING CAT5 + 2 CORES @1.0MMSQ

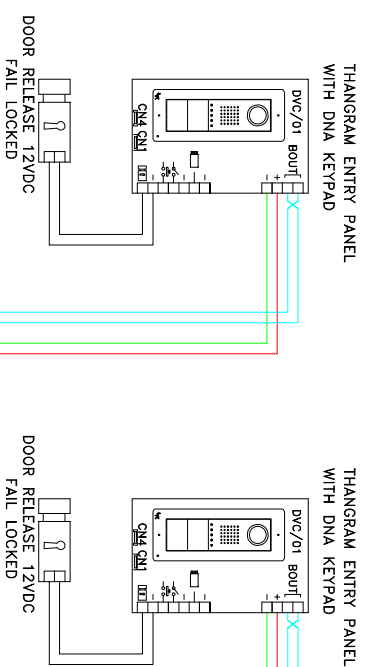

DISTANCE FROM ENTRY PANEL TO VA/01
100M MAX USING VCM/2D OR
100M MAX USING CAT5 + 2 CORES @ 1.0MMSQ

DISTANCE FROM VA/01 TO MONITOR
50M MAX USING VCM/1D OR
25M MAX USING CAT5

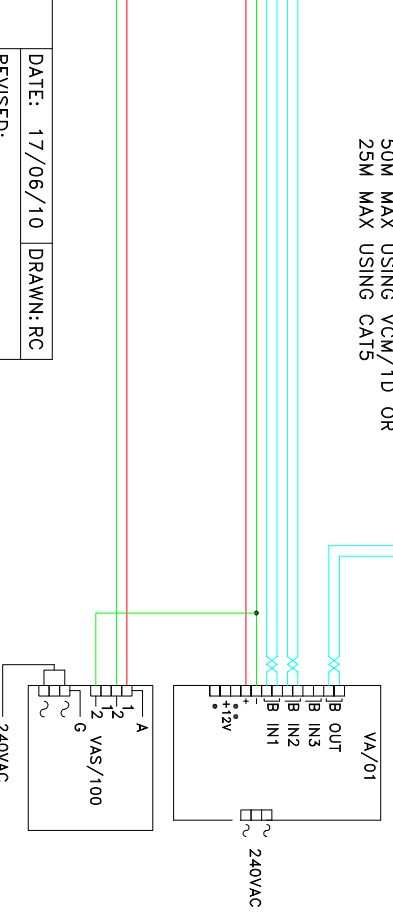
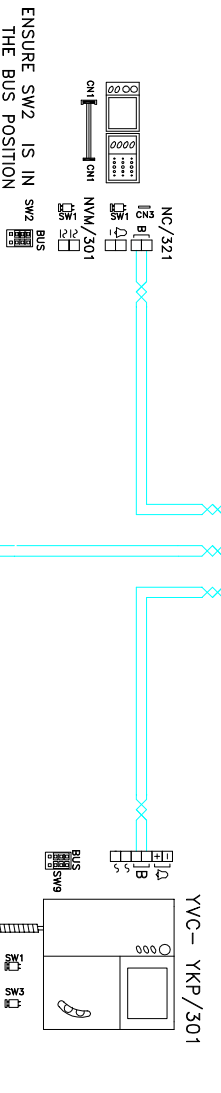
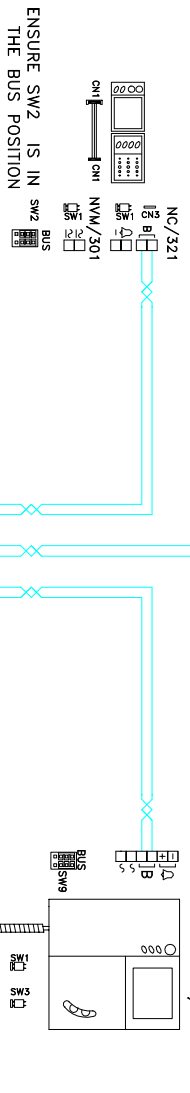
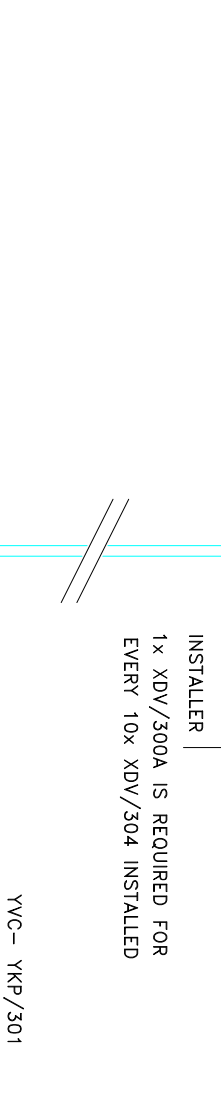
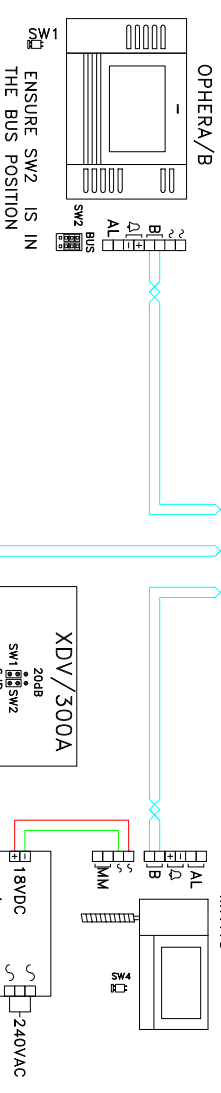
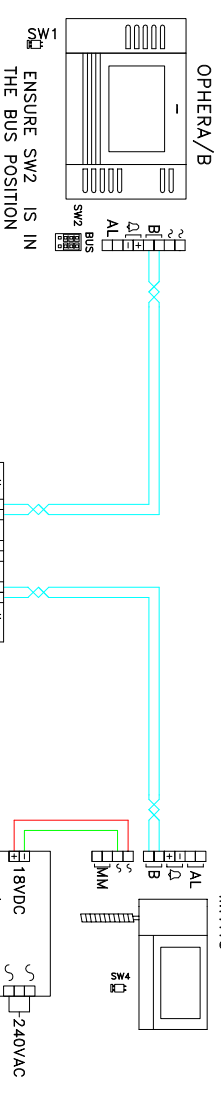

BPT (UK) LTD. HERTS. ENGLAND	PREPARED FOR INSTALLER INFORMATION	DATE: 17/06/10	DRAWN: RC
DRAWING TITLE: 2 x X1 DIGITAL VIDEO ENTRY PANEL & 64 MIXED MONITORS IN A SINGLE RISER		REVISED:	DRAWING No: K-XJ2YNPQNL