

ELVOX

 VIMAR group



DUEFILIELVOX

wide[®]
TOUCH

Hands-free flush-mounted, surface wall-mounted
and desk-top monitor with colour **Touch Screen**
TFT, LCD 7" 16:9 Wide Screen



Hands-free flush-mounted, surface wall-mounted and desk-top monitor with colour **Touch Screen** TFT, LCD 7" 16:9 Wide Screen



Technology and creativity

The first Elvox monitor to feature Touch technology, Wide Touch allows direct access to an increased number of functions, with a simplified menu that brings all options together on a minimum number of screens.

Wide Touch features dual commands—navigate the available options via the 7" LCD screen or use the LED backlit touch keys to access the video door entry functions.

One of the many advantages of the Touch keyboard is that it has the ability to manage up to 100 additional functions made available by Elvox's 2-Wire System, as well as having the capacity to handle 64 intercom calls to different devices as long as they have the same technology.

Wide Touch offers greater flexibility thanks to its Editing function that allows users to assign a name label to each TV camera and other device connected to the system.

Every call displays the name (position) of the entrance panel from which it originates based on the name assigned to it via the installation menu.



Wide Screen display
Touch navigation menu

ELVAX

VIMAR group



Hands-free flush-mounted, surface wall-mounted and desk-top monitor with colour **Touch Screen** TFT, LCD 7" 16:9 Wide Screen



Flexibility of installation

Wide Touch features a password-protected installation menu that allows the installer special access to program some of the main functions of the devices:

- ID code configuration directly from the Wide Touch monitor (without having to confirm the command from the entrance panel) and group configuration;
- Ability to assign auxiliary functions to touch keys;
- Ability to assign a name label to each entrance panel on a system

With Wide Touch, you can also configure entire systems and save all settings on a PC via Elvox's SaveProg software. The monitor features a USB port for direct connection.



TFT colour display
7" LCD Touch Screen

EDVAX

 **VIMAR** group



Hands-free flush-mounted, surface wall-mounted and desk-top monitor with colour **Touch Screen** TFT, LCD 7" 16:9 Wide Screen



The **beauty** of communication

Wide Touch provides access to all the latest methods of communication: audio, images, video and even freestyle handwriting via the device's stylus pen.

It is a monitor capable of handling new and more complex functions bringing innovative methods of communication and event recording to your home and office.

Memo Vision: records images of those who have rung the doorbell, including any voice messages. Memo Vision allows you to check for events that occurred while you were away or unable to come to the door.

Memo Answer: records voice answering machine announcements that can be heard by your visitors.

Memo Family: you can record voice messages to communicate with family members or leave messages to your house help—as well as via other devices connected to the network.

Memo Pictures: records messages written using the device's stylus pen.



Stylus pen













ELVAX

 **VIMAR** group



Hands-free flush-mounted, surface wall-mounted and desk-top monitor with colour **Touch Screen**
 TFT, LCD 7" 16:9 Wide Screen



- 
 Enable/disable automatic recording
- 
 Video door entry menu
- 
 Memo family
- 
 Address book
- 
 Memo picture
- 
 Enable/disable automatic response
- 
 TV camera menu
- 
 Activation menu
- 
 Settings
- 
 Call to concierge

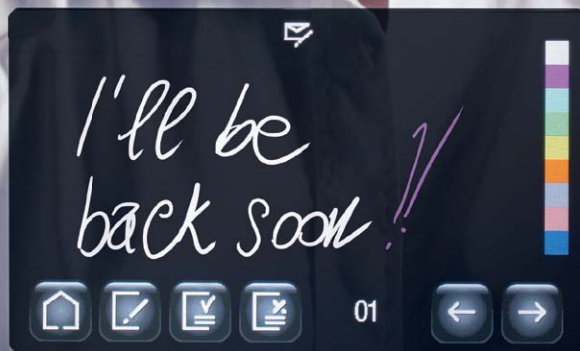

Memo family

Leave a message to communicate with family members
Handwrite your message directly on the message screen by selecting "creative notes".



Memo picture

Hands-free flush-mounted, surface wall-mounted and desk-top monitor with colour **Touch Screen** TFT, LCD 7" 16:9 Wide Screen



Video door entry menu

See who rang the doorbell while you were away or unable to come to the door. You can also choose to respond with a voice message that can be heard by the visitor.



Settings

Select a desktop background image and customise menu controls.

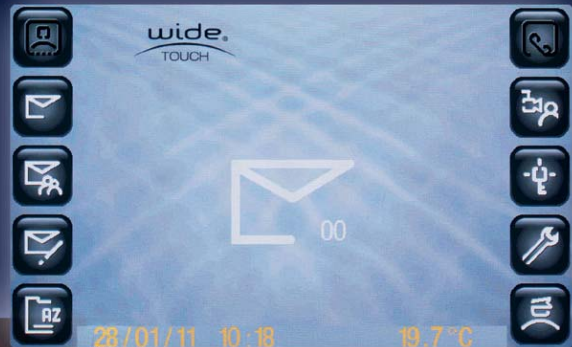



TV camera menu

To record and view images from an additional local camera, connected directly to the door entry monitor. Also from the activations menu it is possible to control up to 16 cameras, using additional modules type 69AM/T and 69AM/T4, which can be selected sequentially via the touch screen.

EDVAX

VIMAR group



Communication has never been this easy

Touch screen controls, a wide range of functions via a simplified menu; a dual command feature providing video door entry access via dedicated touch keys.

Hands-free flush-mounted, surface wall-mounted and desk-top monitor with colour **Touch Screen**
TFT, LCD 7" 16:9 Wide Screen



wide[®]
TOUCH



With desk-top stand



Flush-mounted



Surface wall-mounted

A complete **Suite**

Wide Touch is a complete suite of sophisticated solutions that provides high value in any setting. When flush-mounted, the monitor's slim and sleek design demonstrates precisely just how much technology has been compacted into this sophisticated and elegant product.

In the desk-top version, the monitor can be placed in the most convenient location at work or at home. The surface wall-mounted variant is easy to install and can be easily removed when necessary, which is especially useful when reconfiguring or renovating existing systems.

- Art. 7311** 2-wire 7" Wide Touch Monitor – Flush-mounted – White
- Art. 7311/04** 2-wire 7" Wide Touch Monitor – Flush-mounted – Black
- Art. 7321** 2-wire 7" Wide Touch Monitor – Surface wall-mounted – White
- Art. 7321/04** 2-wire 7" Wide Touch Monitor – Surface wall-mounted – Black
- Art. 730A** Desk-top stand for white Wide Touch Monitor 7311
- Art. 730A/04** Desk-top stand for black Wide Touch Monitor 7311

The desk-top stand is designed to work with a connection cable, which can be ordered separately. The cable is available in white or black to match the colour of the monitor.



White

Black

Refined simplicity

The flush-mounted Wide Touch monitor truly demonstrates just how much research has gone into a project aimed at creating a technologically advanced product that can be discretely added to different rooms, always expressing refined simplicity.

Its slim design when flush-mounted - with a depth of only 18 mm - and the soft corner shape of the monitor make the Wide Touch an elegant addition to interior furnishings with a distinct cutting edge feel. The product is available in black and white.

This device is installed by using the ABS plastic back box (type 7249) and includes a cover that protects the box from the wet mortar (dimensions of hole for flush-mounted units: 189 x 160 x 52 mm).

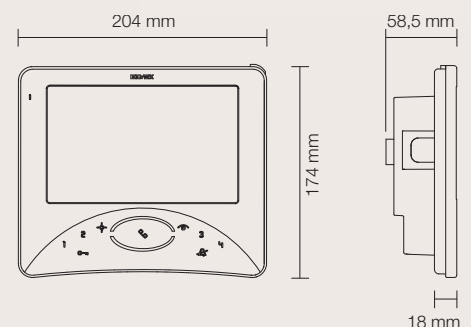

Hands-free flush-mounted, surface wall-mounted and desk-top monitor with colour **Touch Screen** TFT, LCD 7" 16:9 Wide Screen

Desk-top



Desk-top stand
not included with monitor

Available everywhere

You can also benefit from Wide Touch's functionality and convenience on a work or home surface, taking the device's command and system control functionality to the most convenient areas in your workplace and home.

The Wide Touch monitor is supported by a stainless steel stand with a brushed finish (type 730A), which complements the design of the product. The design of the monitor is also emphasised by the stand's simple lines and minimalist structure. The stand (type 730A) includes a 2m-long power cord with a retractable tooth plug.

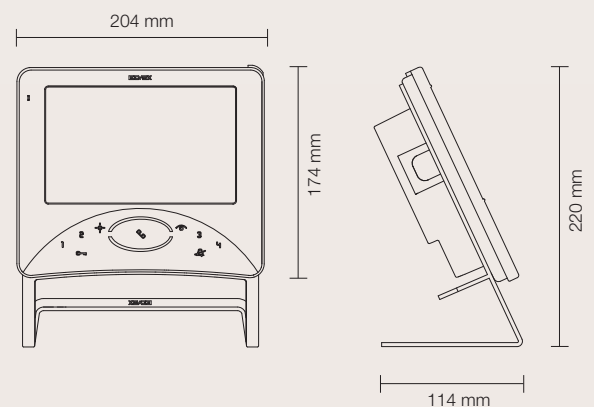

Surface wall-mounted

EDVEX

 **VIMAR** group



Versatile installation

Wide Touch can also be surface wall-mounted, increasing the installation possibilities of the device and allowing use even during renovation work. Wide Touch's slim design means that even when surface wall-mounted the device maintains its sleekness and all of its technological features.

Wall fastening clamps are provided with the device to ensure a quick and accurate installation.

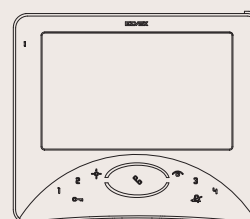

Hands-free flush-mounted, surface wall-mounted and desk-top monitor with colour **Touch Screen**
TFT, LCD 7" 16:9 Wide Screen

wide[®]
TOUCH



Attractive at first sight

EDVAX

 **VIMAR** group



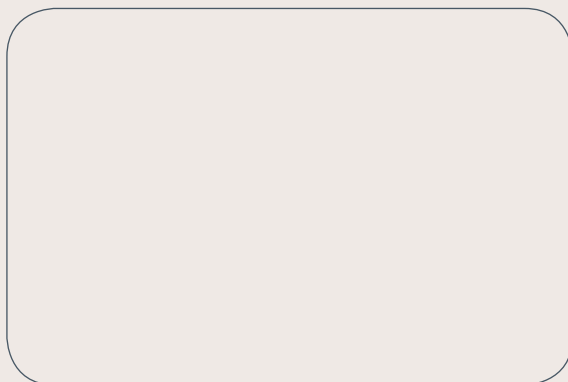

ELVOX

 **VIMAR** group

Via Pontarola, 14/a
35011 Campodarsego PD - Italy
Tel. +39 049 920 2511
Fax +39 049 920 2601
www.elvox.com - elvoxexp@elvox.com